



USER MANUAL

EVOLV

RIDES

CONTENTS

Getting Started.....	1
EVOLV CITY.....	2
EVOLV TOUR.....	6
EVOLV PRO.....	10
Instructions For Battery Usage.....	14
Safety.....	15
Care & Maintenance.....	16
Limited Warranty.....	18

Getting Started

Basic operation:

Power On/Off	Press power button for 3 seconds to turn on scooter. The scooter turns off automatically if not used for 90 seconds.
Speed Control	While stationary, and with the power on, press and release the MODE button to cycle through the three different speed levels 1 to 3. Use the throttle to control the speed within each speed level.
Headlight	While power is on, press and hold MODE button for about 3 seconds to turn on or off headlight.
Mileage & Other data	While stationary, and with the power on, press and release the POWER button to cycle through the following data: ODO (lifetime mileage), TRIP mileage, VOLTAGE level, ELECTRICAL CURRENT level and ERROR CODE. To reset the TRIP mileage, while TRIP mileage is displayed, hold down MODE button for 3 seconds.



EVOLV CITY



EVOLV CITY: Technical Specifications

Model	EVOLV CITY
Battery	LG 36V 10.4Ah
Tires	8.5 inch, pneumatic front, solid rear rubber
Brakes	Rear drum brake
Range*	30 - 40 km
Top Speed (Limited Option)	35 km/h (25 km/h)
Weight	18 kg
Suspension	Front spring & rear hydraulic suspension
Lights	Front and rear lights
Motor Power	350W gearless motor
Max. Load	120 kg

*Range may vary depending on rider weight, riding style, terrain and tyre pressure.

EVOLV CITY: Unfolding



EVOLV CITY: Folding



Step 1:
Turn power off

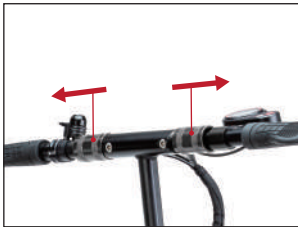

Step 2:
Slide locking sleeves
outward to release grips

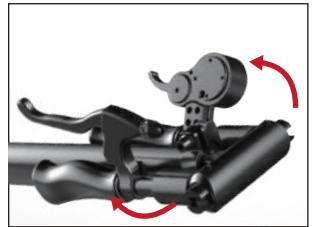

Step 3:
Fold down handle grips

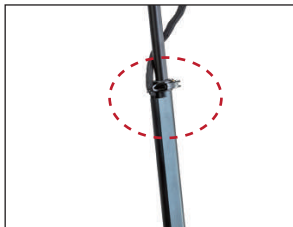

Step 4:
Open the quick-release clamp



Step 5:
Shorten T-bar



Step 6:
Lift the folding lever and push the steering column forward at the same time to release the folding mechanism. While holding down the lever, fold the steering column down towards the deck until it locks into position.

EVOLV TOUR



EVOLV TOUR: Technical Specifications

Model	EVOLV TOUR
Battery	LG 48V 10.4Ah / LG 48V 13Ah
Tires	8.5 inch pneumatic front & rear
Brakes	Front disc and rear drum brake
Range*	30 - 40 km / 40 - 50 km
Top Speed (Limited Option)	40 km/h (25 km/h)
Weight	18 kg
Suspension	Front spring & rear hydraulic suspension
Lights	Front and rear lights
Motor Power	500W gearless motor
Max. Load	120 kg

*Range may vary depending on rider weight, riding style, terrain and tyre pressure.

EVOLV TOUR: Unfolding

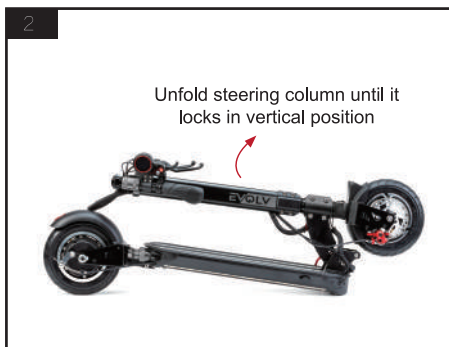

EVOLV TOUR: Folding



Step 1:
Turn power off

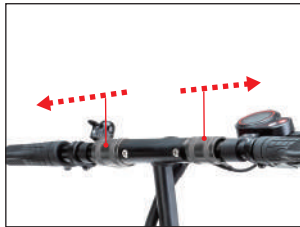

Step 2:
Slide locking sleeves
outward to release grips

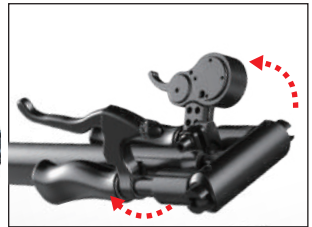

Step 3:
Fold down handle grips

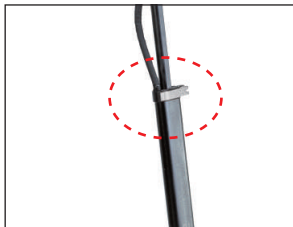

Step 4:
Open the quick-release clamp



Step 5:
Shorten T-bar

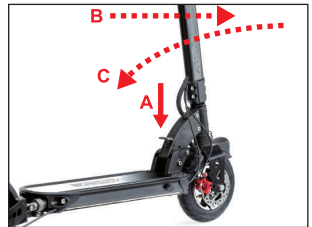

Step 6:
(A) While pressing down on the folding lever, push steering column forward (B) to unlock joint. Keeping the lever pressed down (A), fold the steering column towards the deck (C) until it locks into position.

EVOLV PRO



EVOLV PRO: Technical Specifications

Model	EVOLV PRO
Battery	Sinc 52V 18.2Ah / LG 52V 23Ah
Tires	10 inch pneumatic front & rear
Brakes	Dual disc brake
Range*	65 - 70 km / 85 - 90 km
Top Speed (Limited Option)	65 km/h (25 km/h)
Weight	35 kg
Suspension	Front & rear spring & hydraulic suspension
Lights	Front and rear lights
Motor Power	1000W Dual Drive
Max. Load	150 kg

*Range may vary depending on rider weight, riding style, terrain and tyre pressure.

EVOLV PRO: Unfolding

1

Unlock the clamp



2

Unfold steering column



3

Secure the clamp





Instructions for battery usage

First Charge

It is important to fully charge the battery before your first use of the scooter.

Features of the battery

Your scooter's battery comes with these built-in features:

1. **Balanced charging protection:** During charging, the battery automatically balances the voltage among the internal cells to protect each cell.
2. **Over-charging protection:** The battery stops charging automatically when full to protect against damage.
3. **Over current protection:** The battery automatically stops charging if the voltage is higher than prescribed voltage to protect the battery.
4. **Over discharging protection:** The battery automatically stops discharging when its voltage drops below 44V to protect the battery.
5. **Short-circuit protection:** the battery automatically stops output in the case of a short-circuit.
6. **Auto sleep:** The battery automatically enters sleep mode if there is no load for 20 minutes to conserve power.

How to charge

1. Ensure that scooter is **TURNED OFF**. Connect external power charger to scooter.
2. Connect charger to electrical outlet, then turn on the power of electrical outlet.
3. Do not charge the batteries in temperatures below 5 °C or above 40 °C. The battery may stop the charging process.

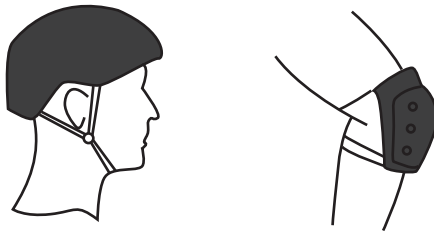

Safety

1. Always wear protective equipment like a safety-certified helmet, gloves, elbow guards, and knees guards.
2. Do not ride on rough, unpaved or uneven surfaces. Do not ride on surfaces with ice, snow or water.
3. Not suitable for riders below of 15 years or above 60 years old. Minors must be supervised.
4. Do not ride when under the influence of alcohol or other intoxicating substances.
5. Avoid riding in cold winter days.
7. Do not ride on rainy days.
8. Slow down on slopes; do not ride on slopes of steeper than 15 degrees in gradient.
9. Before riding, always do a visual inspection to check that all nuts and bolts are secure; that there is enough tyre pressure and the tyres are not worn out; that the brakes are functioning properly.
10. It is your responsibility to know and follow the laws governing the use of electric scooters in the country you ride in.

Cleaning & Storage

Before cleaning, be sure to turn off the scooter and disconnect it from the wall electrical outlet. Close the charging port to reduce chances of water entering it, causing damage or electric shock.

Remove dirt or dust with a damp cloth. For stubborn dirt, scrub with a toothbrush and wipe clean with a damp cloth. Scratches on plastic parts can be removed or reduced with sandpaper.

Do not use alcohol, petrol, kerosene or other corrosive chemicals to clean the scooter. Never spray water directly onto the scooter with a hose.

Store scooter indoors in a cool, dry place. Storage in high or low temperatures, in direct sunlight or exposed to the weather will damage the scooter and its battery.

Maintenance and care of the battery

1. To avoid damage or injury, do not replace the battery with that of another model or brand.
2. Do not touch, dismantle or puncture the battery. Do not allow the battery to come into contact with metal objects.
3. Only use the original charger supplied with this scooter. Do not attempt to charge the scooter with any other charger.
4. After using the scooter, fully charge the battery before storing it to prolong the lifespan of the battery.
5. Do not store the scooter or battery in temperatures higher than 50 °C or lower than -20 °C. For example, do not store the scooter in a car exposed to the sun or in winter.
6. Do not dispose of the battery in fire.
7. If the scooter will not be used for more than 30 days, fully charge it before storing in a cool, dry place. The unused scooter should be fully charged once every 60 days, otherwise the battery may be damaged or may fail. Such battery failures are not covered by warranty.

IMPORTANT

Always recharge the battery before it is fully depleted.
Over-discharging shortens the lifespan of the battery.

Battery range is reduced at low temperatures. For example, at -20°C , the battery range may be less than half that at normal temperature.

If the battery is not charged for a long time, it may no longer be usable. The fully charged battery will be completely discharged in 120 to 180 days even without use. Damage from such cause is not covered by warranty.

Never disassemble the battery because there is a risk of short circuit and injury.

Limited Warranty

BY USING THIS PRODUCT YOU AGREE TO THIS LIMITED WARRANTY. PLEASE READ THIS LIMITED WARRANTY CAREFULLY.

To benefit from the limited warranty, the customer is advised to read Evolv Inc. Limited Warranty terms together with the “care and maintenance” sections provided in the user manual. This limited warranty applies to the extent permitted by law and unless restricted or prohibited by law.

Limited Warranty Details

1. Evolv warrants that Evolv scooter products (“Products” or “Product”), are free from defects in material and workmanship, according to the following terms and conditions:
2. This Limited Warranty extends to the original purchaser of the Product warranted under this warranty and to each transferee of the Product during the first _____ months beginning on (date) _____ as stated below (“Warranty Period”).

This Limited Warranty covers the Product and each of its following component parts (“Components”) only:

- a. Hub motor;
 - b. Battery packs (except if battery was short circuited or seals of the battery enclosure or cells were broken or were tempered or the battery was used in equipment other than its intended use);
 - c. Controller;
 - d. Throttle and battery indicator unit;
 - e. Charger unit; and
 - f. All other electrical wiring and components.
3. During the Warranty Period, Evolv or its authorized service centres will repair or replace, at Evolv’s option and without costs to the customer, any defective Components with new or factory rebuilt replacement items, and return the Products to the customer in working condition, provided that the terms and conditions of this Limited Warranty are met. All defective Products or Components that have been replaced shall become the properties of Evolv.
 4. Products and/or Components that have been repaired or replaced pursuant to the paragraph above will be covered by this Limited Warranty for the balance of the Warranty Period.

5. This Limited Warranty will only be effective when presented together, to either Evolv or its authorised centres, with proof of date and place of purchase of Products such as the purchase receipt.

What this Limited Warranty does not cover:

1. Products used for commercial purpose(s) including but not limited to leasing/hiring, use in competitions etc
2. Any logistical costs of returning the Product to Evolv or its authorised service centres for servicing or the cost of returning the Product to the customer after servicing.
3. Defects or damages resulting from use of the Product(s) other than its normal and customary manner as stated in the user manuals accompanying the Products.
4. Defects or damages from improper storage, exposure to moisture or dampness, modifications, connections, repairs (except as carried out by Evolv or its authorised centres), misuse, neglect, abuse, accident, alteration, improper installation, or other acts which are not the fault of Evolv, including damage caused by dropping, blown fuses, spills of food or liquid.
5. Defects or malfunctions of the product not notified by customer during the Warranty Period.
6. Products which have had their serial numbers removed or tampered with.
7. This Limited Warranty is in lieu of all other warranties, express or implied either in fact or by operations of law, statutory or otherwise, including, but not limited to any implied warranty of marketability or fitness for a particular use.

Disclaimer:

1. The customer understands the risk of serious injury or death in the operation of such products and shall agree to take the **necessary precautions** and exercise **good judgement** to avoid hazards and dangerous situations which may result in serious injury or death.
2. The customer shall agree to indemnify and hold harmless Evolv from all injuries or death arising from the operation of the product.
3. The use of safety and protective gear such as bicycle helmets is strongly encouraged. And so is the use of Good Judgement.

Limited Warranty

4. The customer is advised to take the following precautions:
 - a. Do not ride on wet ground or in heavy rain;
 - b. Take corners slowly and look out for pedestrians;
 - c. Avoid potholes, kerbs and debris on the ground;
 - d. Keep tires pumped to the specified pressure;
 - e. Dismount in places with heavy human traffic and push the scooter manually;
 - f. Service the product every 3 months on regular usage, 6 months for non-frequent usage;
 - g. Do not use product on public roads and respect local road regulations.

How to request service under this Limited Warranty:

To obtain performance of Evolv to repair and/or replace the Product or its Components under this Limited Warranty, the customer must, during the Warranty Period:

1. Bring this Limited Warranty, proof of purchase and the Product to Evolv.
2. Provide Evolv with a written description of the problem.

The average repair time is 1 to 3 days, not including shipping time to and from our service centre.

This warranty does not cover the shipping costs associated with the transportation of the scooter to and from our service centre, and a fee will be charged for return shipping or pick up and delivery service.

What can the consumer do in case of a dispute with Evolv

The consumer and Evolv agree that in the event of a dispute arising from the material and workmanship of the Product; or from this Limited Warranty, parties will attempt to first resolve the matter by negotiating in good faith. If this fails, parties agree to submit the dispute to the Small Claims Tribunal of British Columbia and agree to be bound by any order made by the said Tribunal.



EVOLV Rides
www.evolvrides.com