

180 cm SLIDING DOOR WARDROBE

Assembly Instruction

!!WARNING In order to prevent overturning/ toppling over, this product must be used with the wall attachment device provided. However you will need to source suitable fixings for your wall type. If in doubt, please consult a qualified trades person. Always ensure the wall to be drilled is free from hidden electrical wires, water and/or gas pipes or any other obstruction.

!!Please take time to read and follow these instructions carefully!!

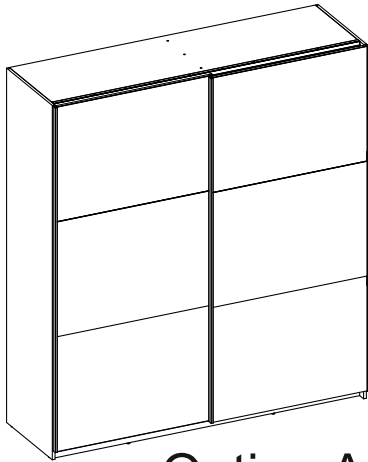

Option A

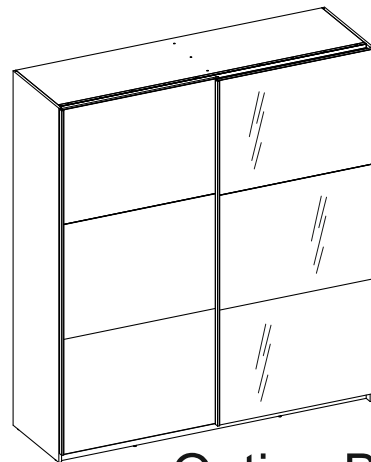

Option B

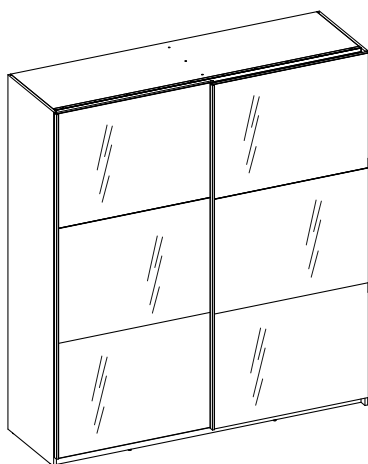

Option C

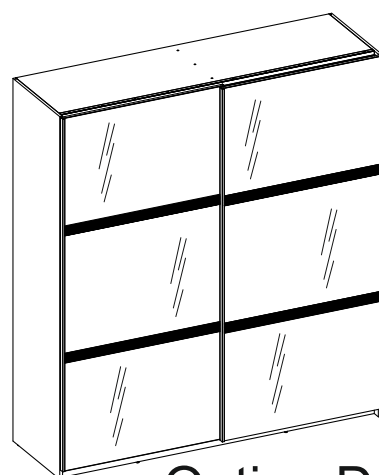

Option D

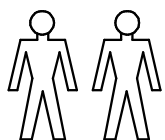

x2

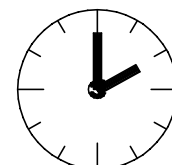

Approx 2h



Safety and Care Advice

IMPORTANT, RETAIN FOR FUTURE REFERENCE: READ CAREFULLY.

- Keep children and animals away from the work area, small parts could choke if swallowed.

- Make sure you have enough space to layout the parts before starting.

- This product has been constructed to be used in the domestic environment only and not for commercial purposes.

- Assemble the item as close to its final position (in the same room) as possible.

- Assemble on a soft level surface to avoid damaging the unit or your floor.

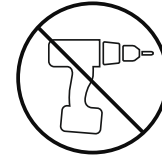

- We do not recommend the use of power drill/drivers for inserting screws as this could damage the unit. Only use hand screwdrivers.

- Parts of the assembly will be easier with 2 people.

- Dispose of all packaging carefully and responsibly.

Care and maintenance

- Only clean using a damp cloth and mild detergent. Do not use abrasive cleaners.

- Use a dry cloth to clean the product, furniture polish is not recommended.

- From time to time check that there are no loose screws, nuts or bolts. If there are please re-tighten.

- This product should not be discarded with household waste. Take to your local authority waste disposal centre.

Fittings (Shown to scale)

Wardrobe

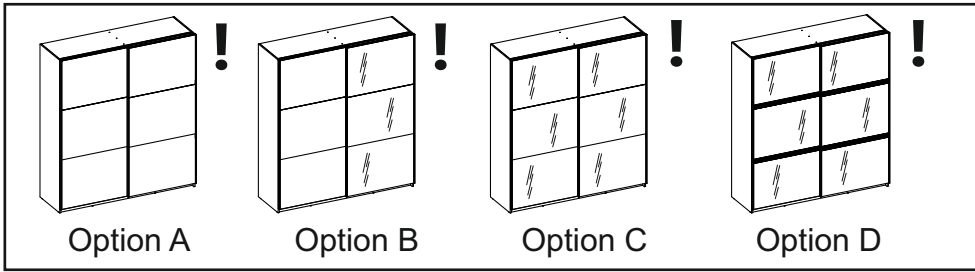

WARNING!
 IN ORDER TO PREVENT OVERTURNING
 THIS PRODUCT MUST BE USED WITH
 THE WALL ATTACHMENT DEVICE
 PROVIDED

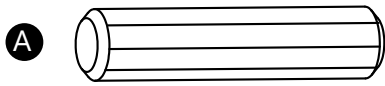

A 8x35 Wooden Dowel x26

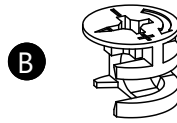

B Locking Cam x18



C 16mm Screw x10

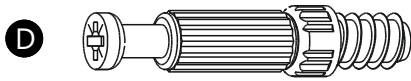

D Metal Dowel x18

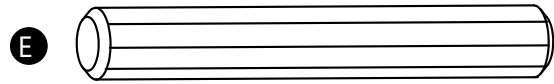

E 8x60 Wooden Dowel x3



F 13mm Screw x4

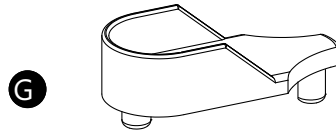

G Hanging Rail Support x4



H Cam cover x18

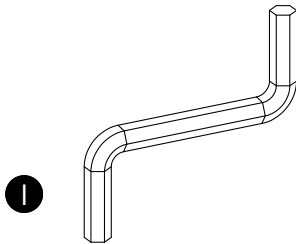

I Key x1



J 16mm Screw x100



K Foot x8

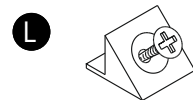

L Plastic Wedge x16

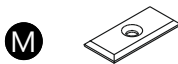

M Back Support x10



N 20mm Screw x10



O Plastic angle x4

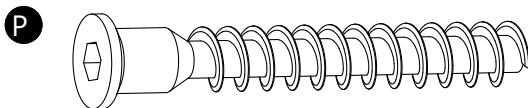

P 50 mm Screw x3



R Door joint bracket x12

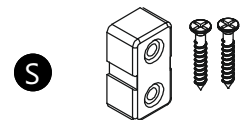

S Door stop x2

Hardware

Wardrobe

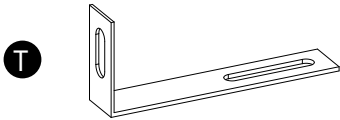
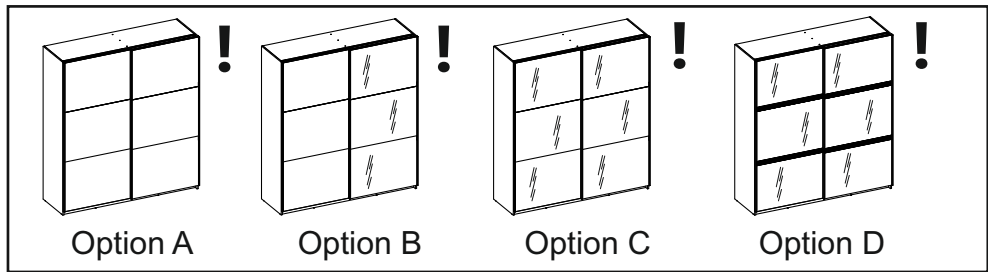

Wall Fixing Bracket x 2

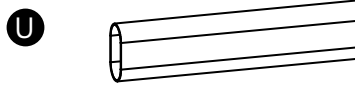

Hanging Rail x 2

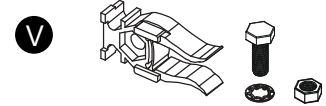

Door Stop x 2

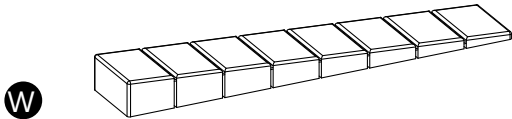

Levelling Wedge x 1

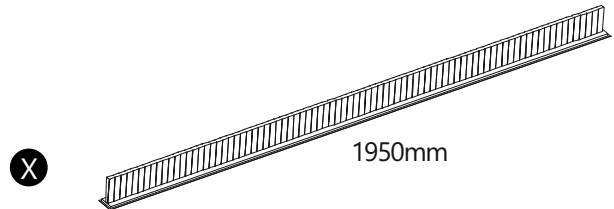

Brush x 1

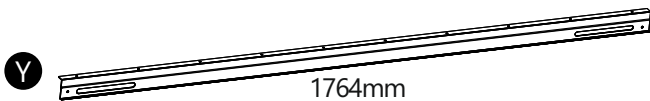

Top Rail x 1

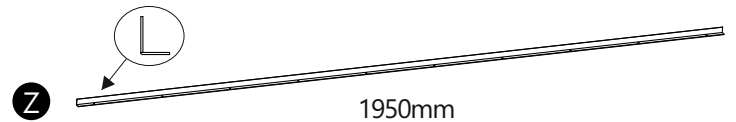

Door End Strip x 1

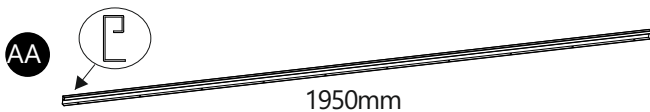

Handle x 3

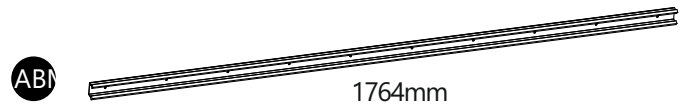

Bottom Rail x 1

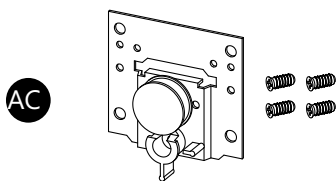

Top Door Bracket x 1

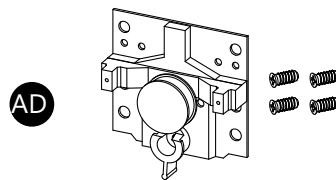

Top Door Bracket x 1

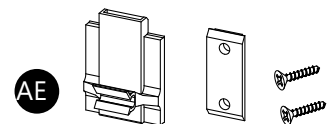

Bottom Door Guide x 2

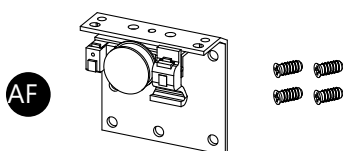

Top Door Bracket x 1

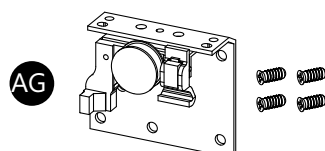

Top Door Bracket x 1

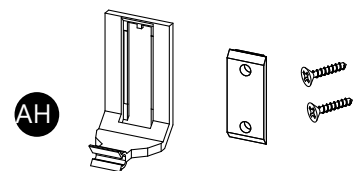

Bottom Door Guide x 2

Tools required

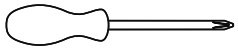

Phillips screwdriver
(small & medium)

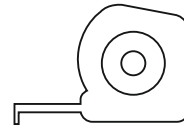

Ruler/tape
measure

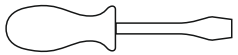

Flat screwdriver
(small & medium)

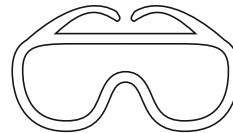

Eye protection
(when using a
hammer or glue)

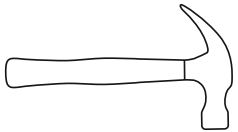

Hammer



Pencil

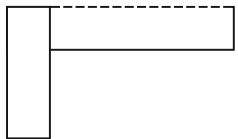

Set Square

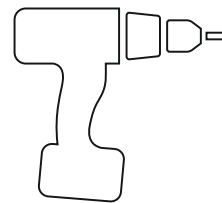

Power Drill



Drill Bits

Wall Fixing Only



Spirit Level



Small Step Lader

Panels Frame

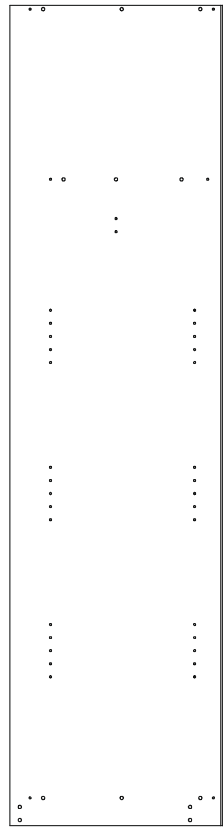
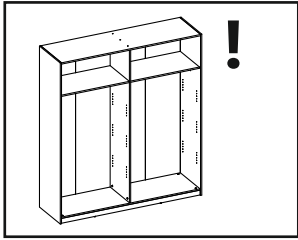

1 Left Side Panel
(2005 x 529mm)

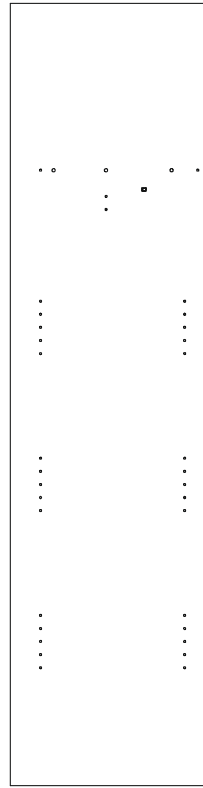

2 Vertical Partition Panel
(1912 x 490mm)

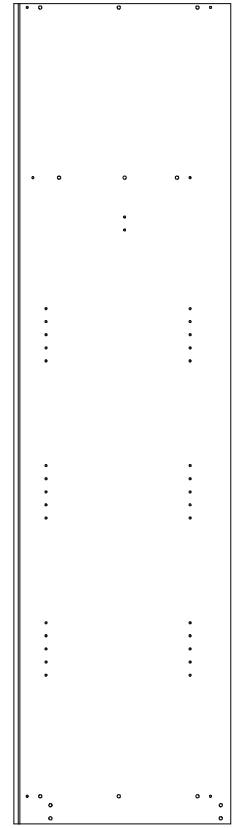

3 Right Side Panel
(2005 x 529mm)

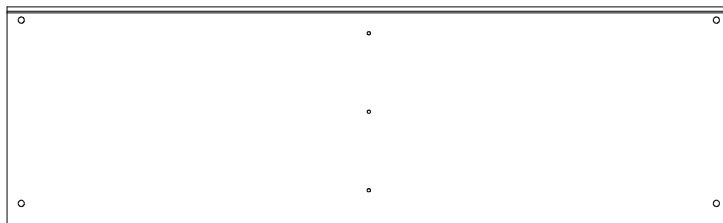

4 Top Panel (1768 x 514mm)



5 Horizontal Shelf Panel
(876 x 488mm)

(x2)

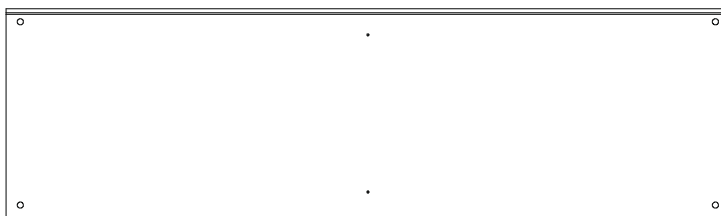

6 Bottom Panel (1768 x 514mm)

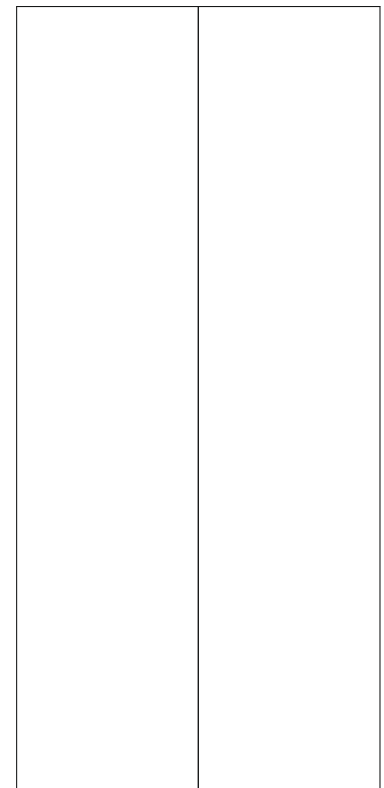

8 Back Panel
(1922 x 888mm)

(x2)

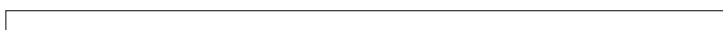

7 Plinth (1768 x 60mm)

(x2)

Panels Doors

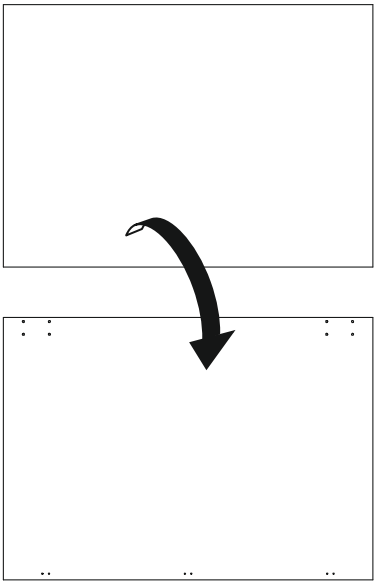
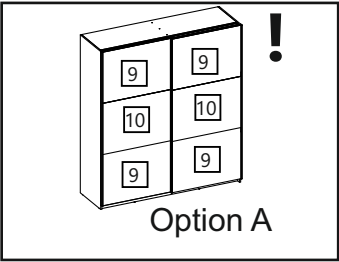

9 Upper, Lower Door (914 x 650mm) **(x4)**

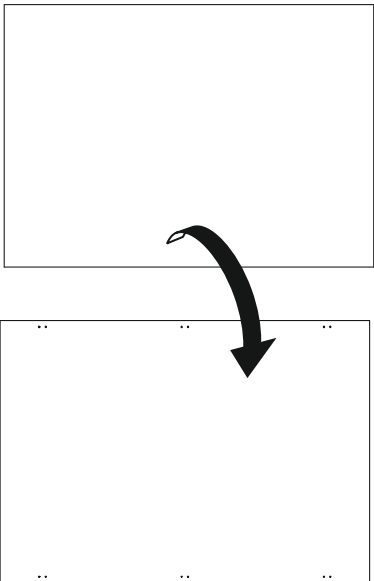

10 Middle Door (914 x 650mm) **(x2)**

Panels Doors

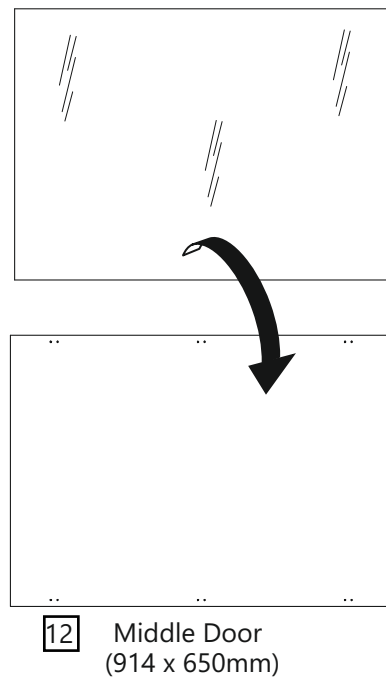
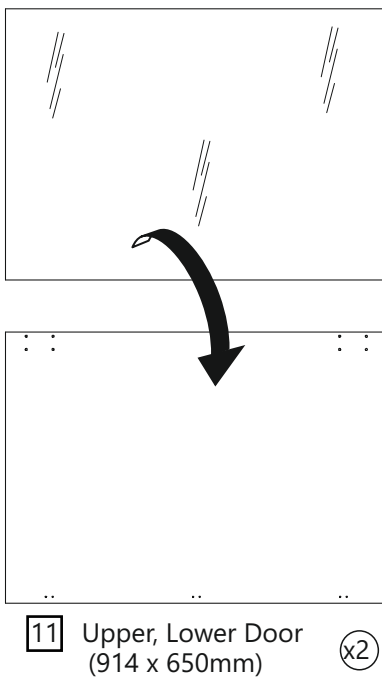
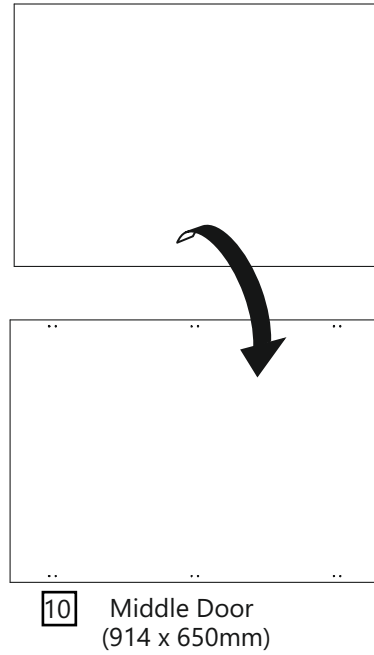
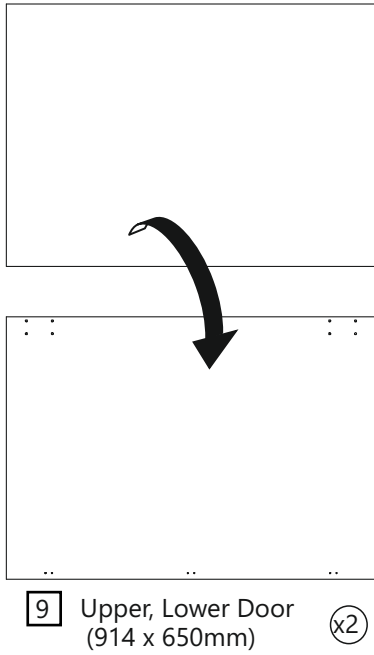
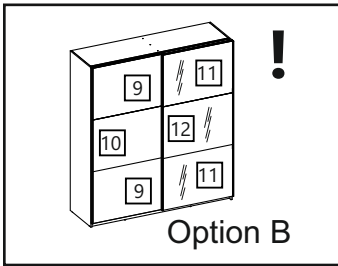

Panels Doors

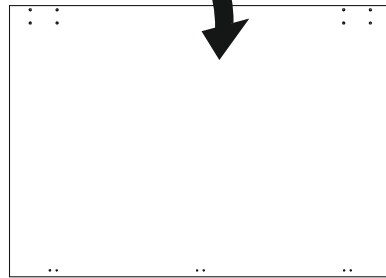
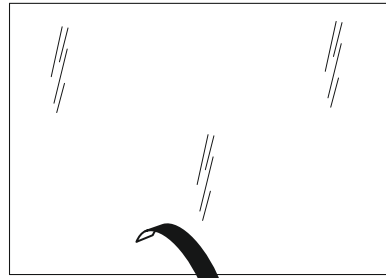
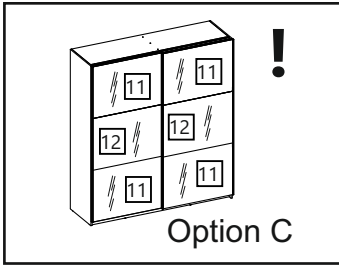

11 Upper, Lower Door (914 x 650mm) (x4)

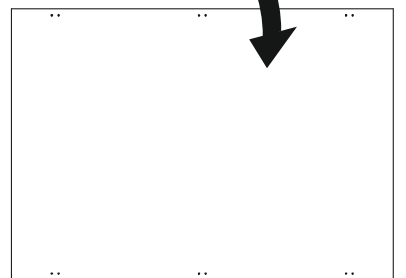
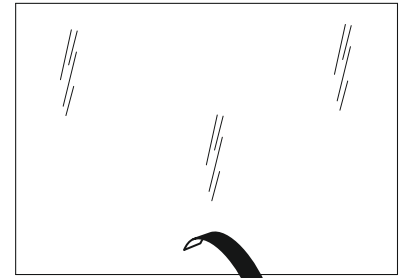

12 Middle Door (914 x 650mm) (x2)

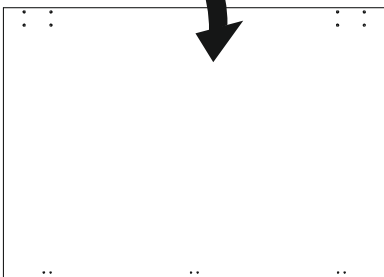
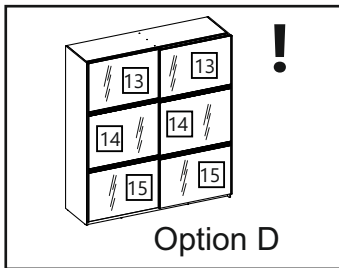

13 Upper Door (914 x 650mm) (x2)

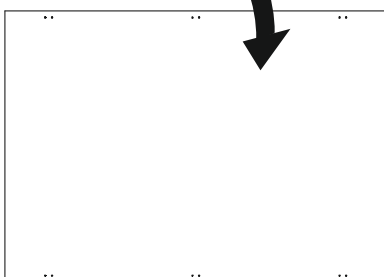

14 Middle Door (914 x 650mm) (x2)

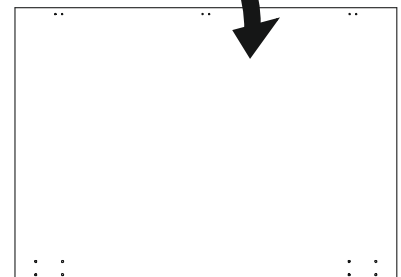
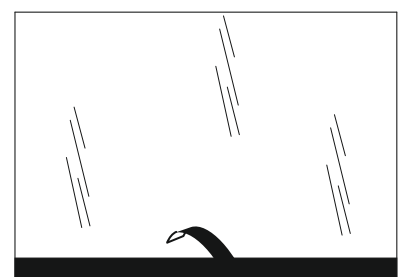

15 Lower Door (914 x 650mm) (x2)

Wardrobe Frame
Pages 10>21

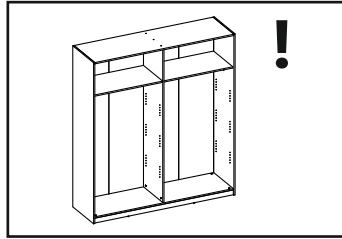

WARNING!
IN ORDER TO PREVENT OVERTURNING
THIS PRODUCT MUST BE USED WITH
THE WALL ATTACHMENT DEVICE
PROVIDED

1

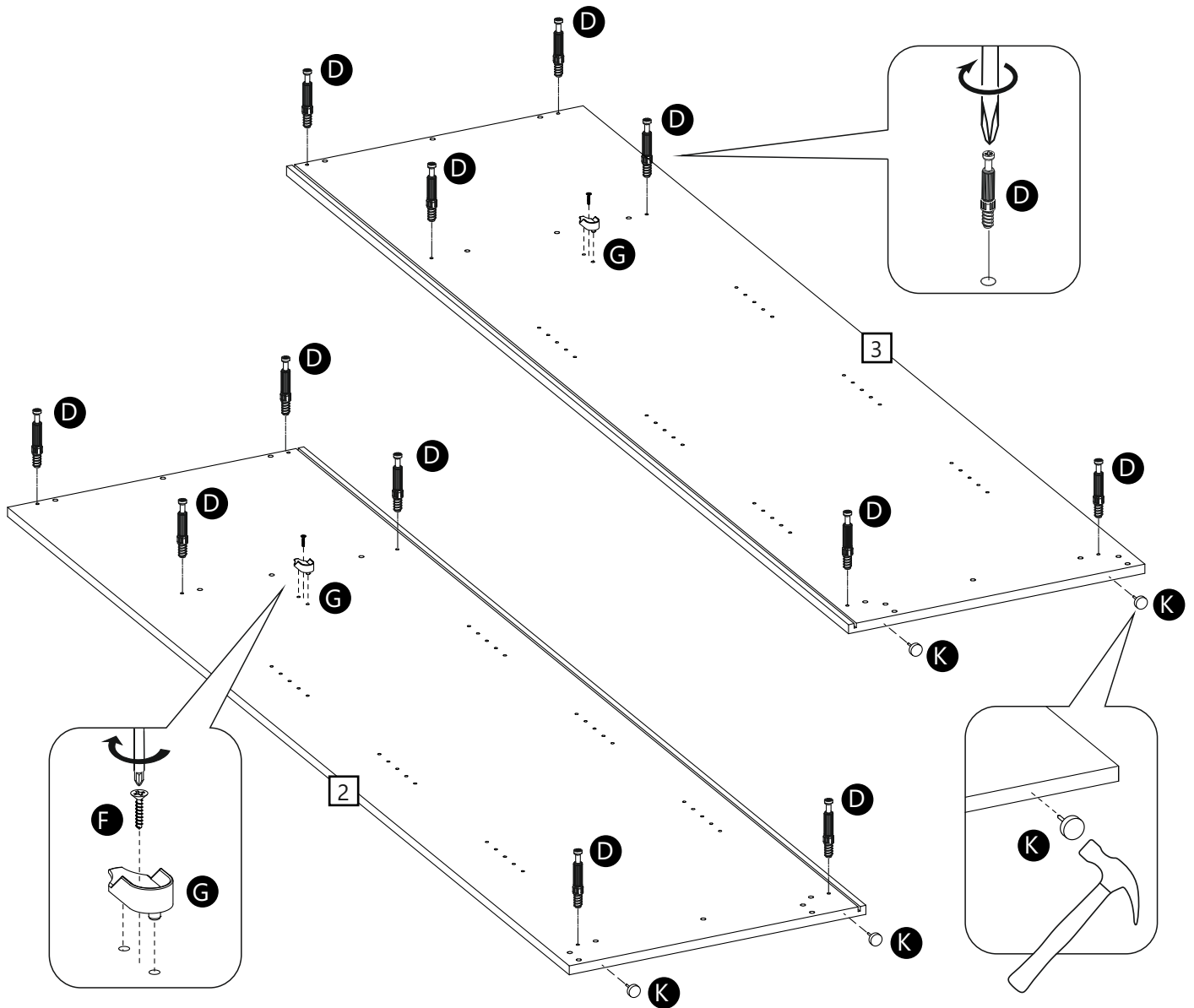
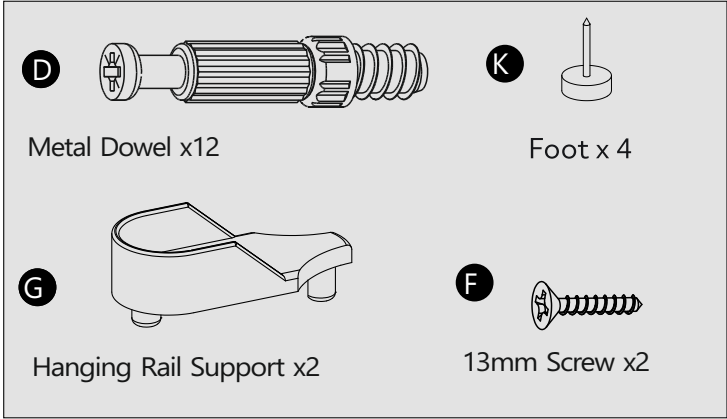
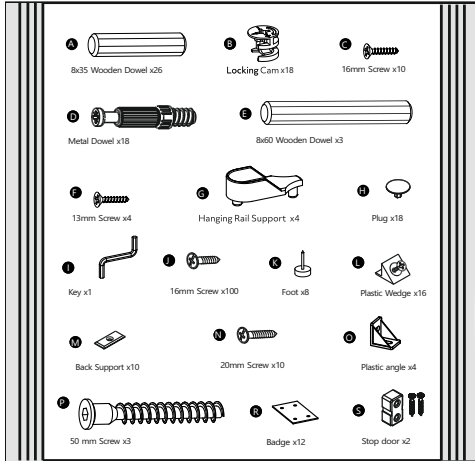

2

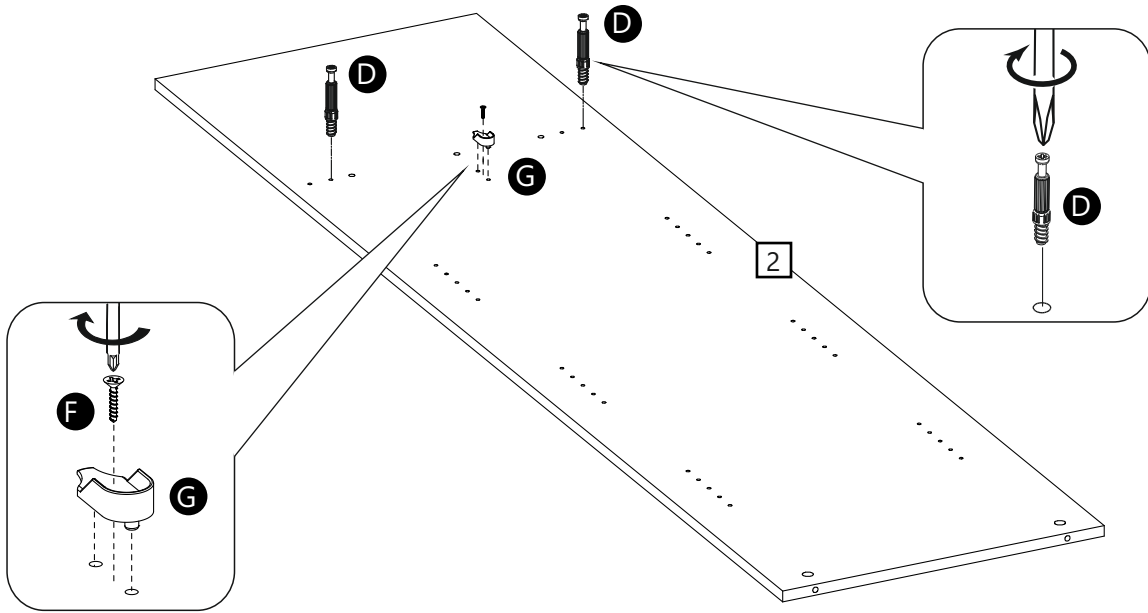

3

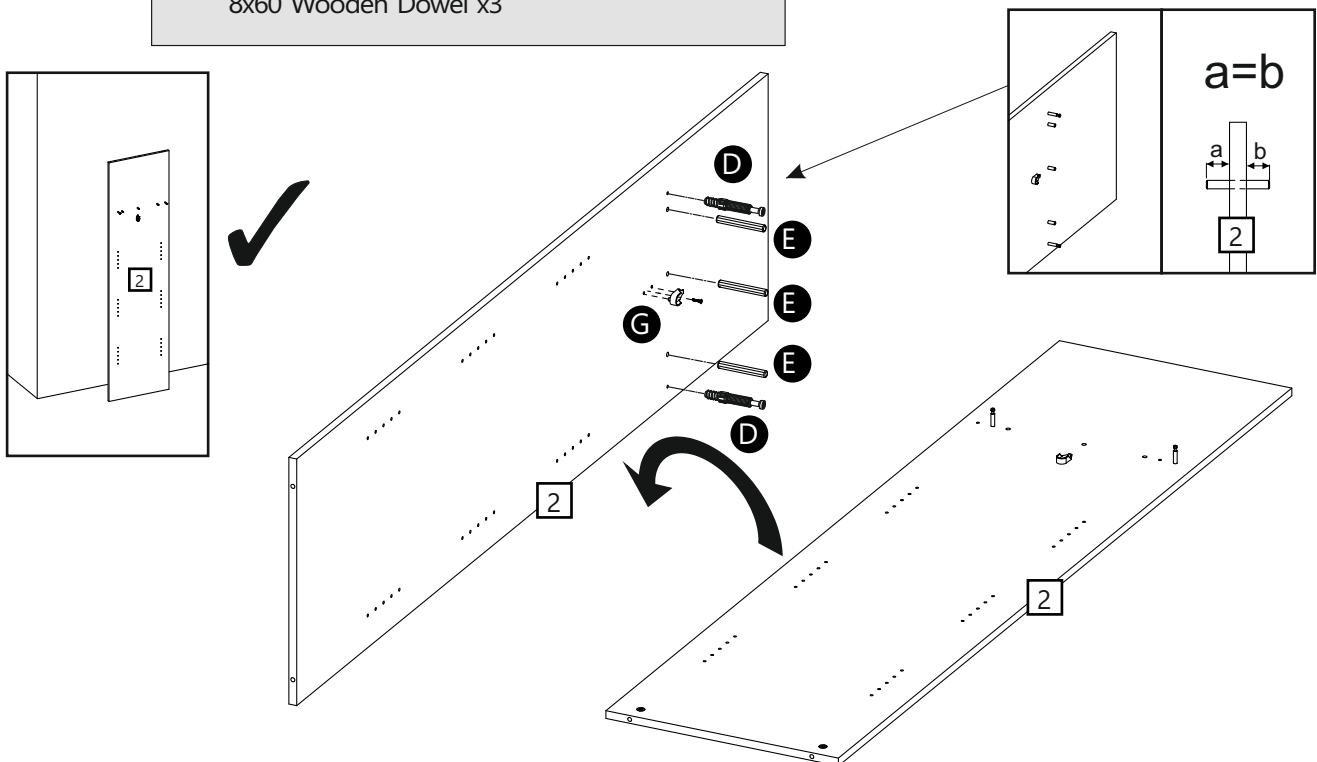
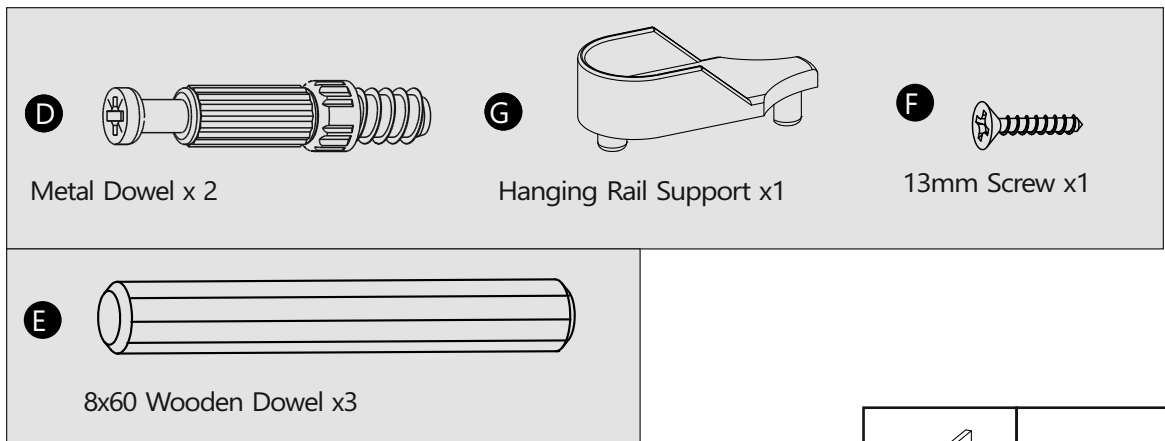

4

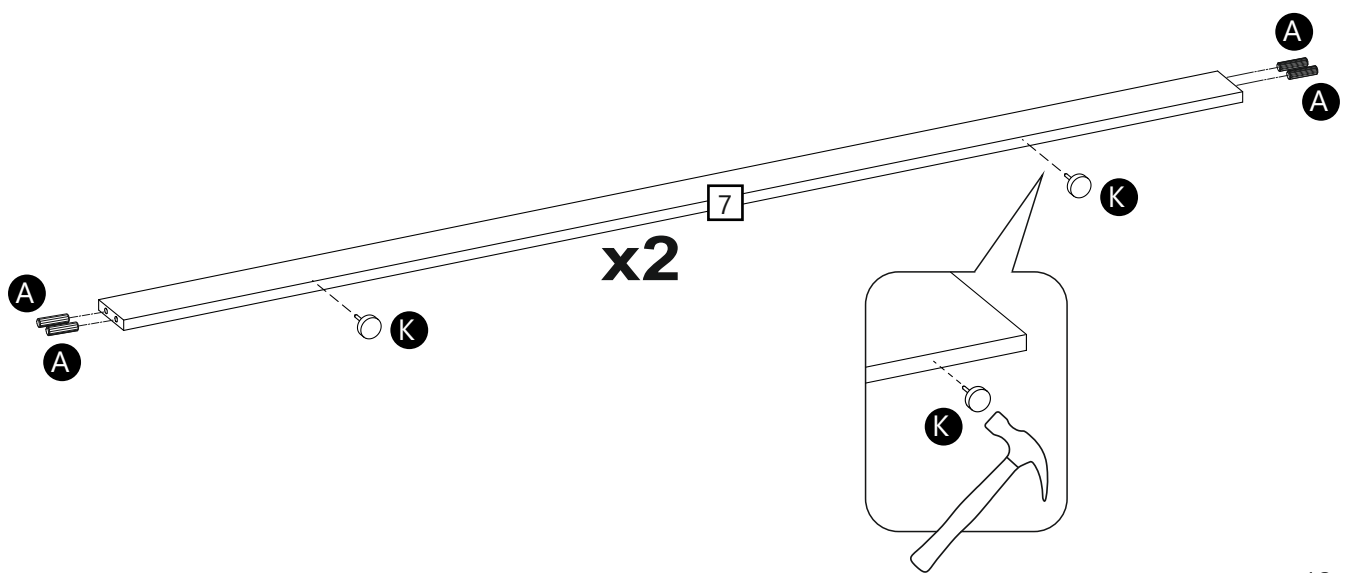
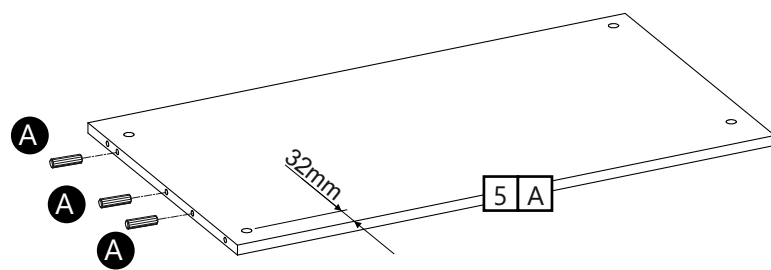
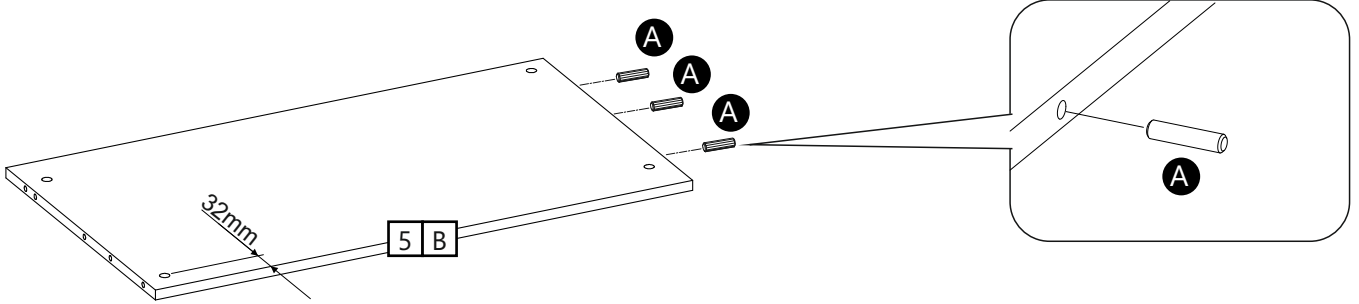
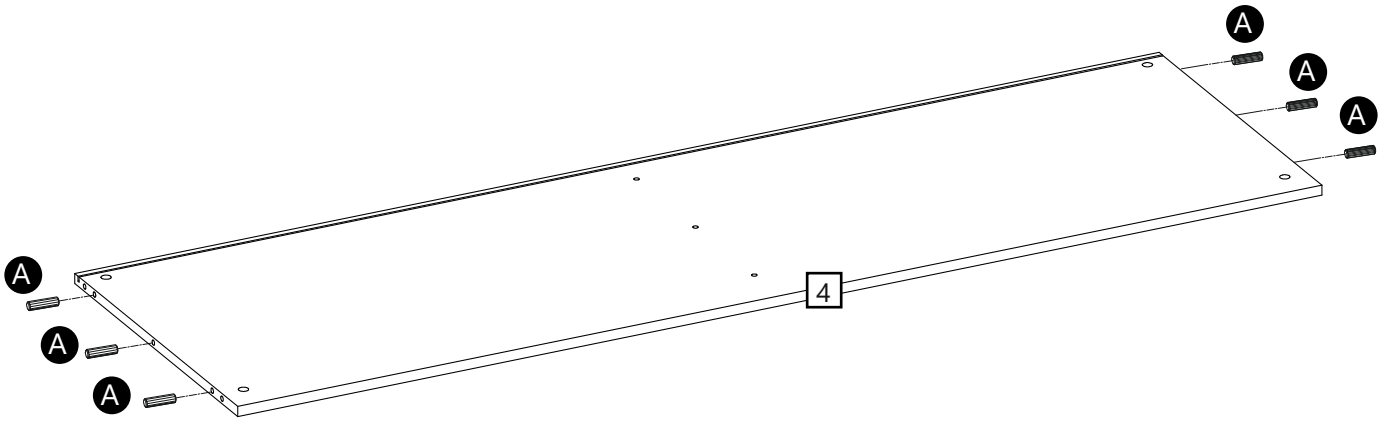
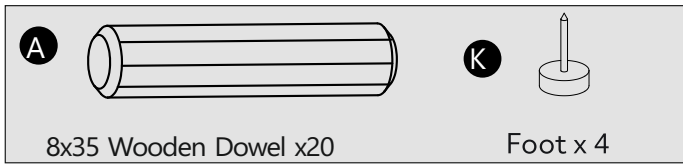

5

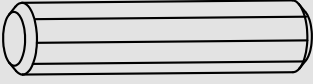
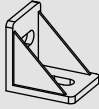
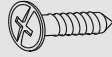
 8x35 Wooden Dowel x6	 Plastic angle x4	 16mm Screw x4
--	--	---

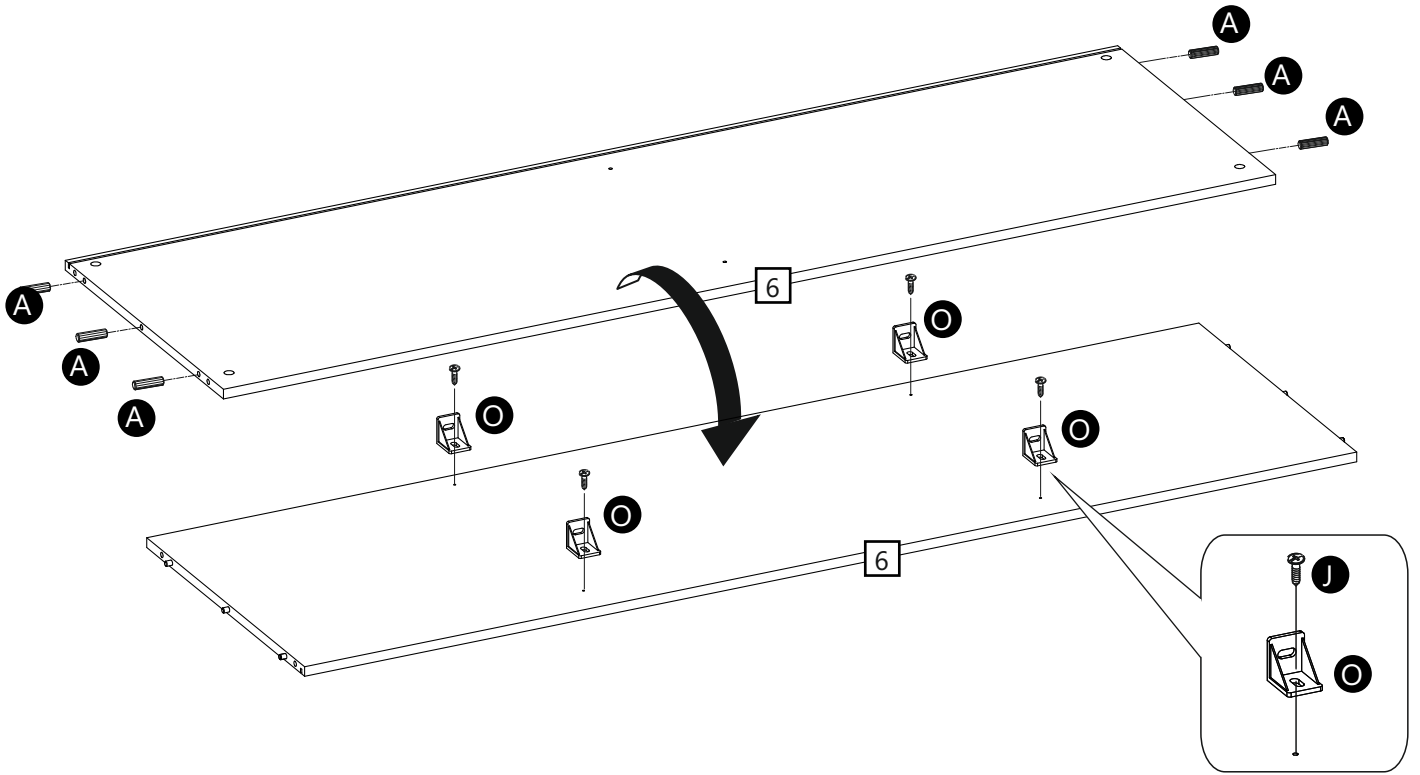

6

 16mm Screw x4
--

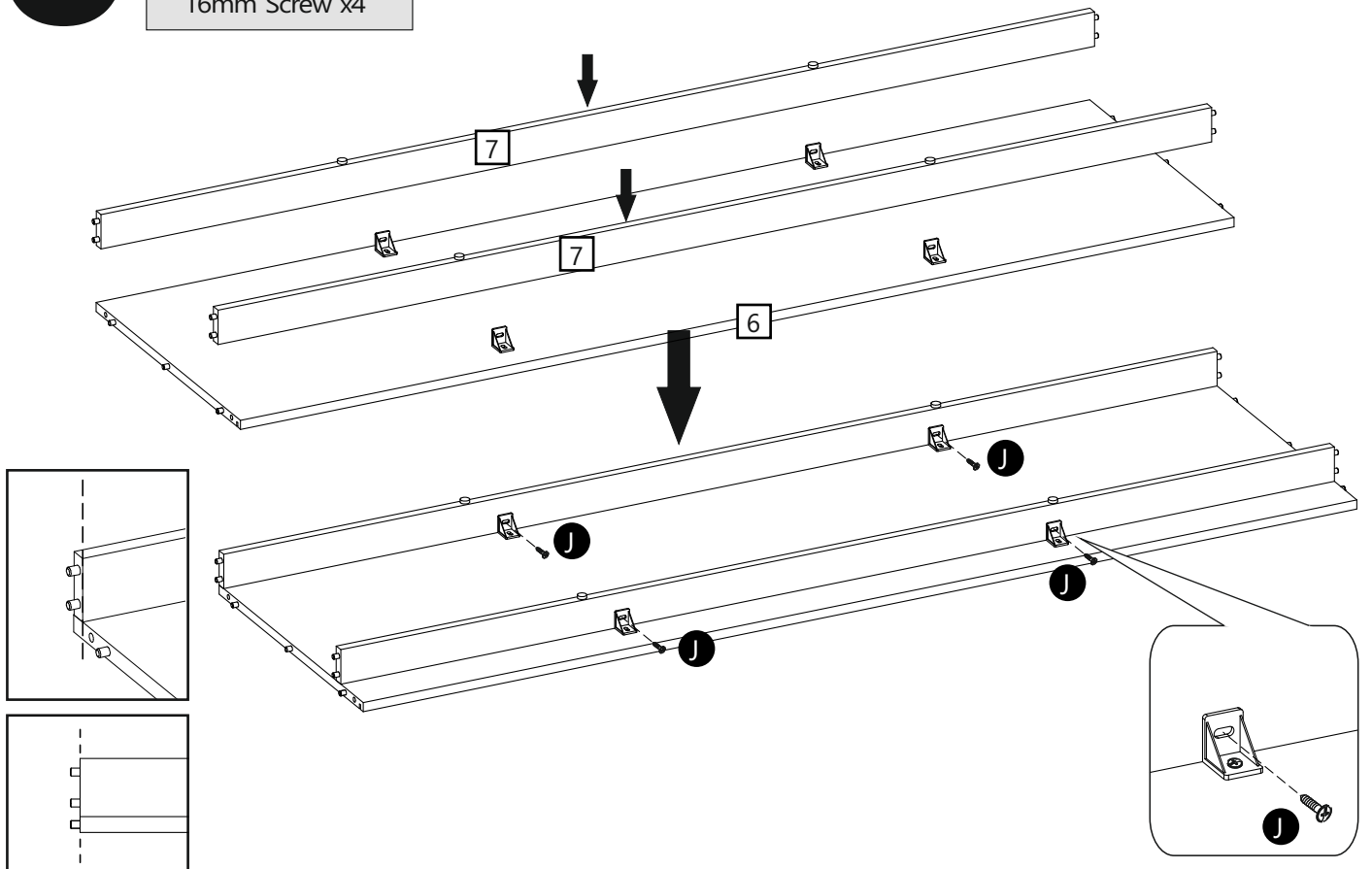

7

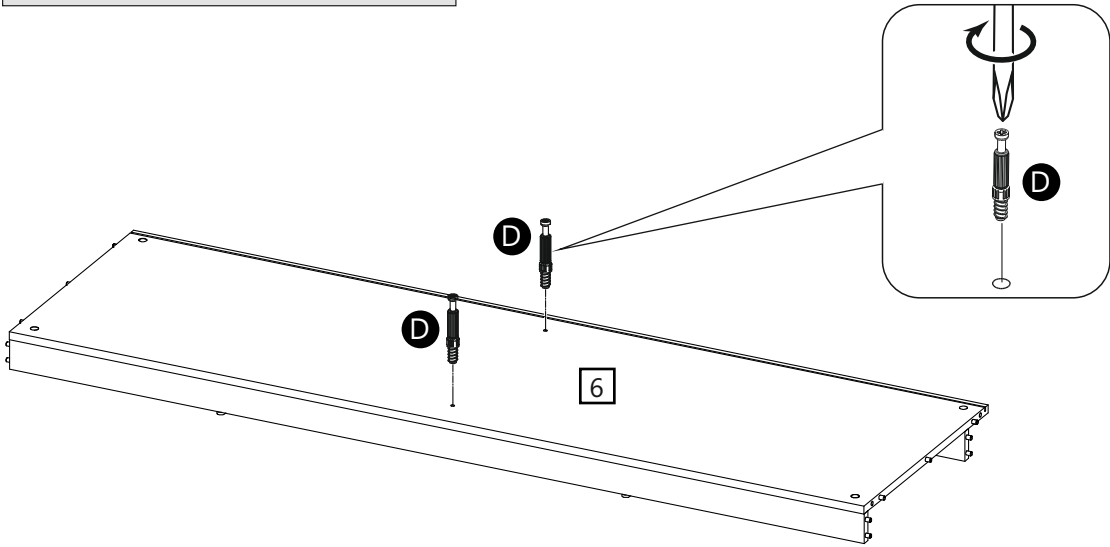
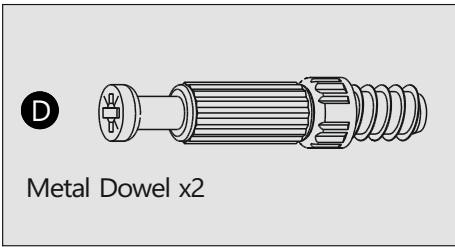

8

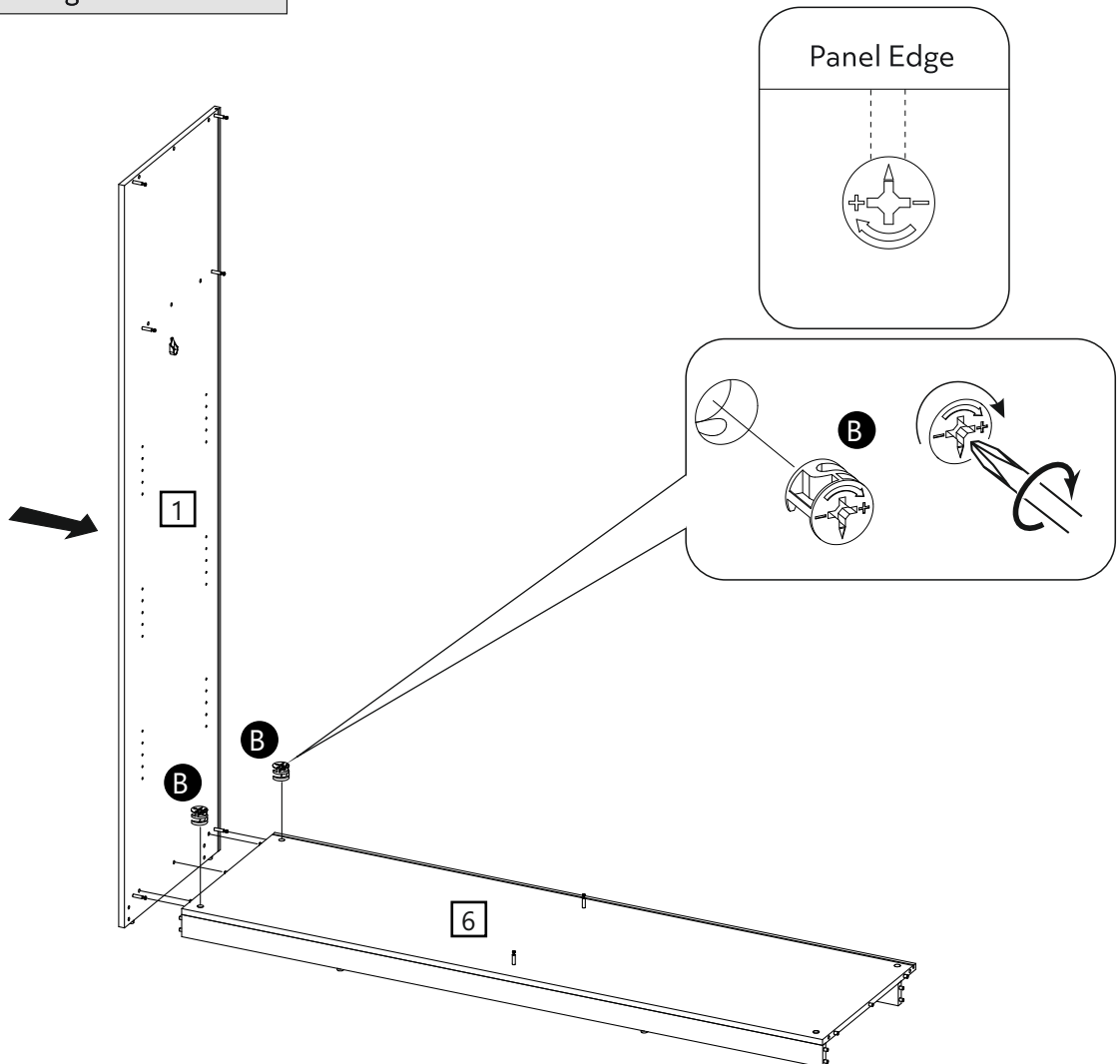
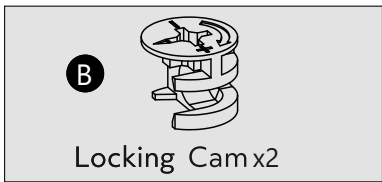

9

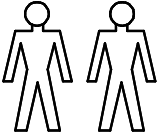
B Locking Cam x2	 x2
----------------------------	---

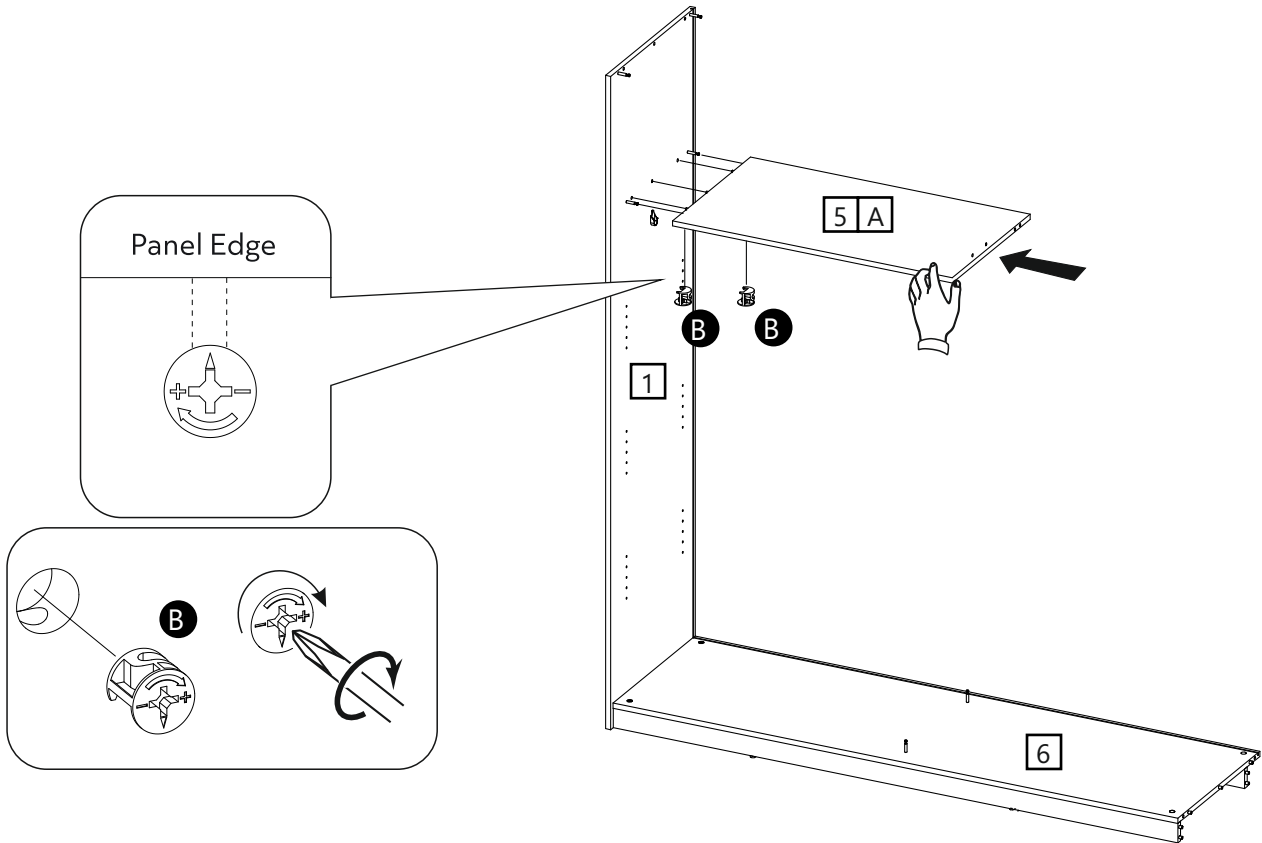

10

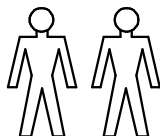
B Locking Cam x4	 x2
----------------------------	--

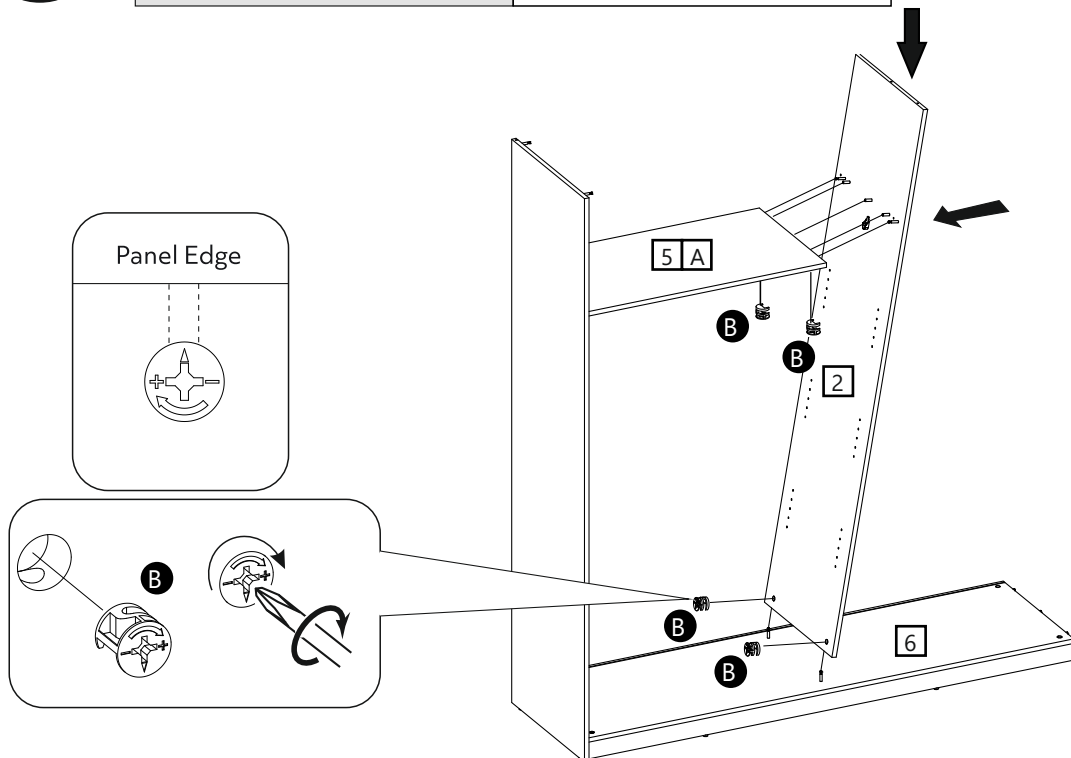

11

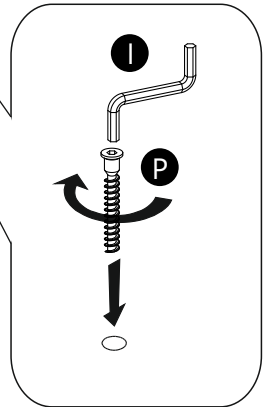
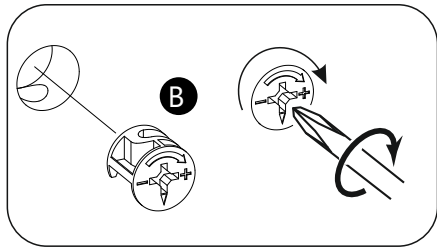
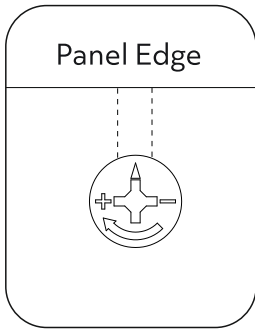
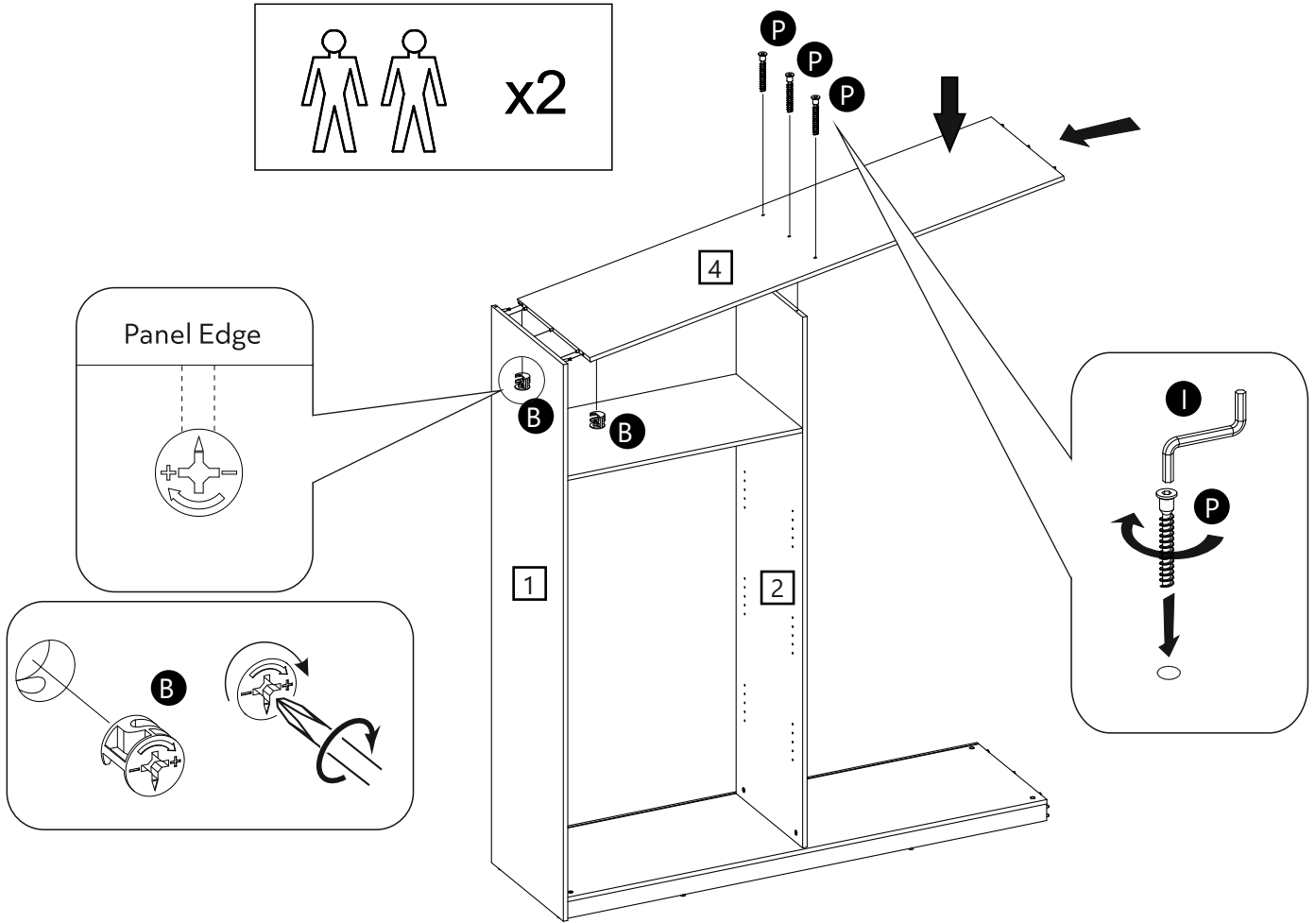
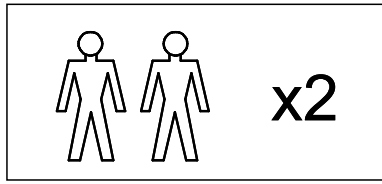
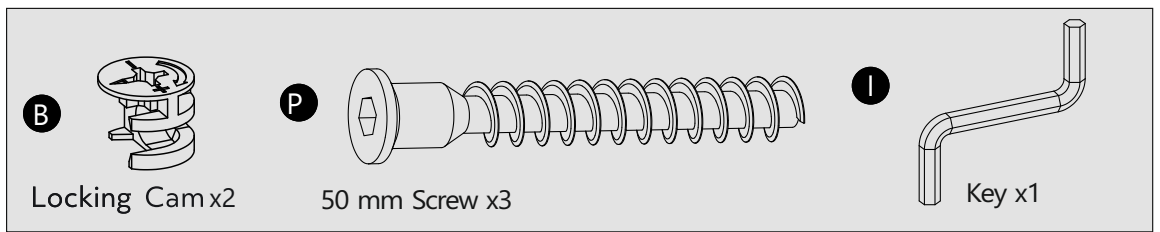

12

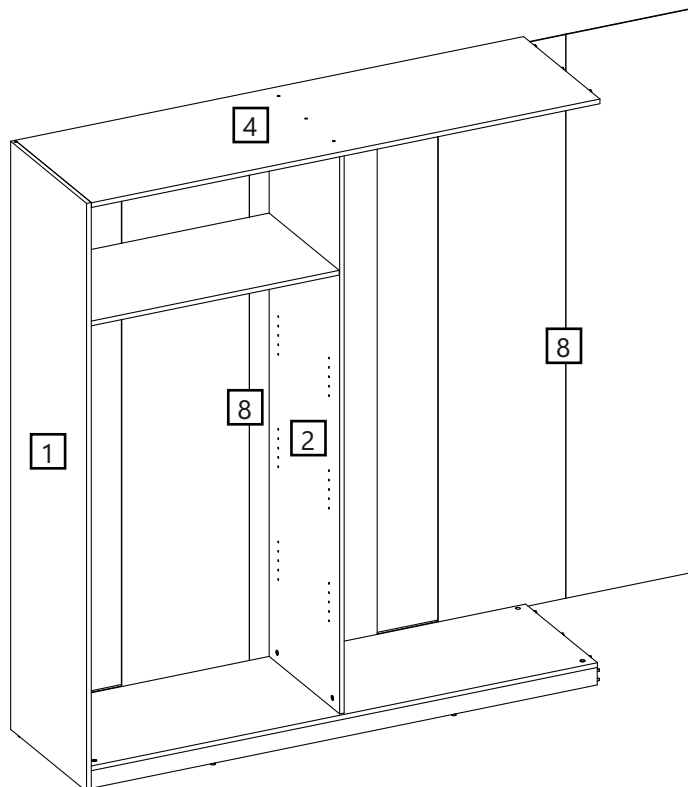
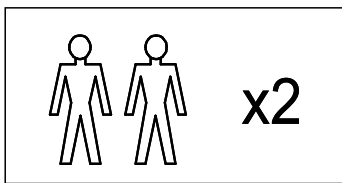

13

B 
Locking Cam x2

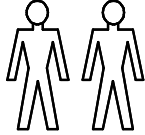
 x2

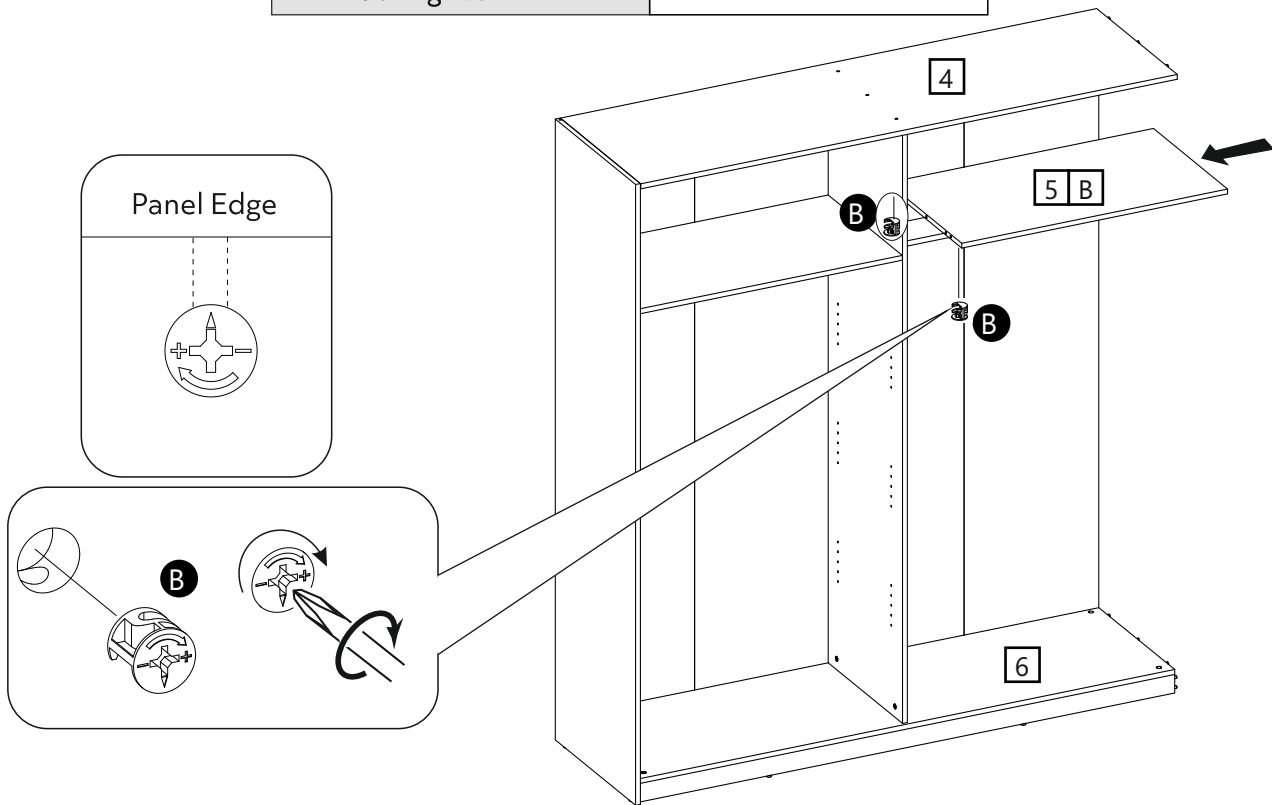

14

B 
Locking Cam x6

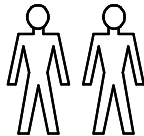
 x2

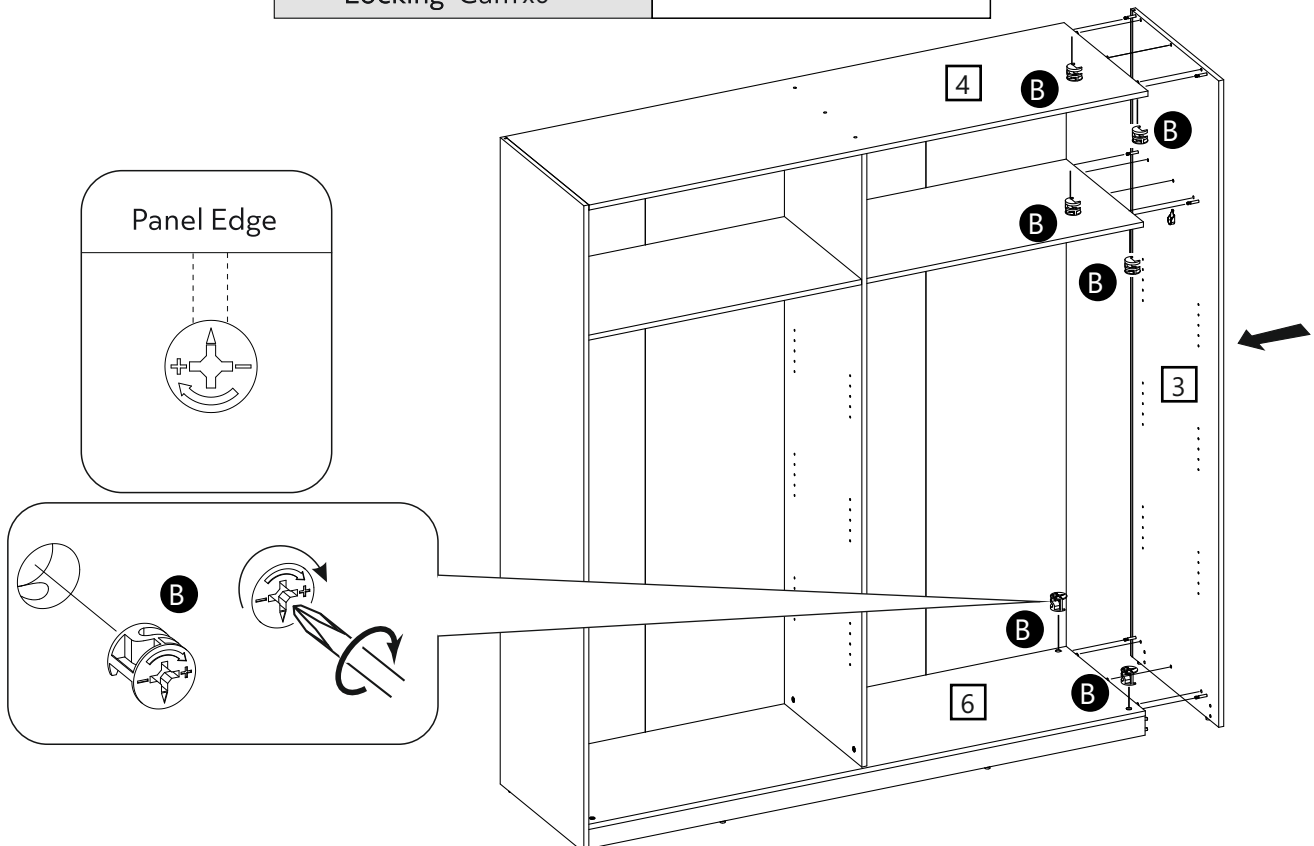

15

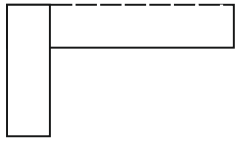
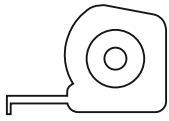
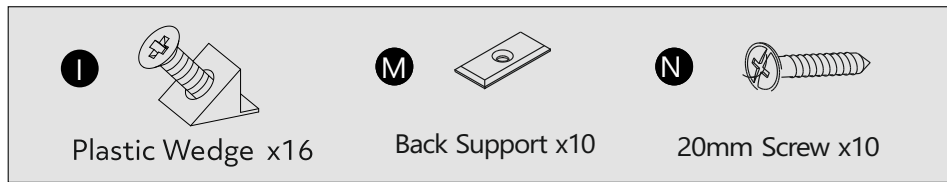

A=B

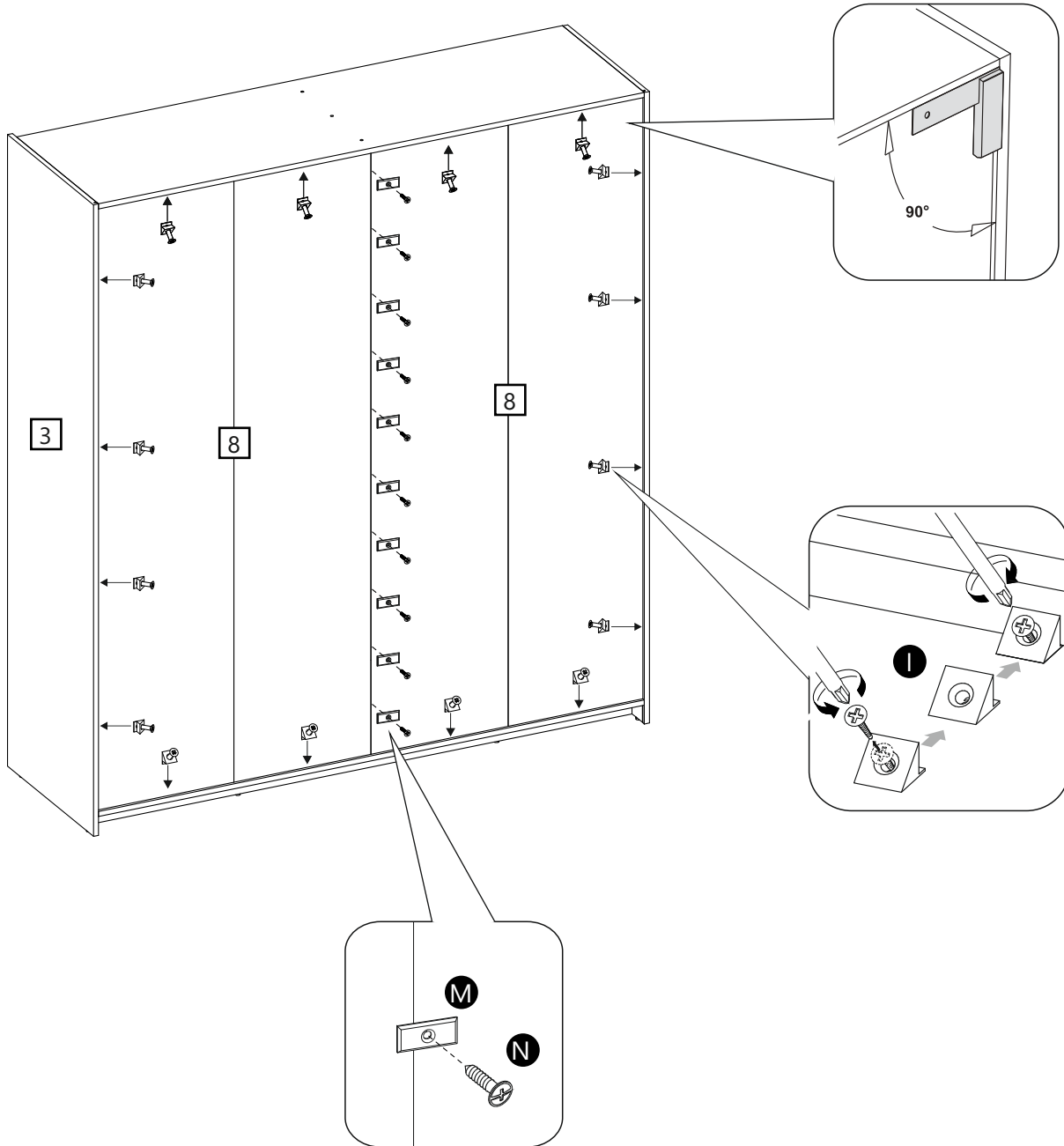
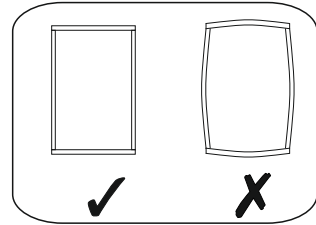
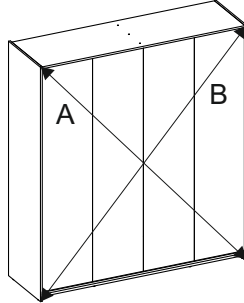

16

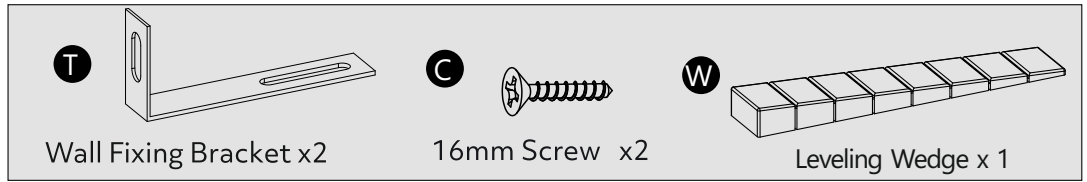

WARNING!
IN ORDER TO PREVENT OVERTURNING
THIS PRODUCT MUST BE USED WITH
THE WALL ATTACHMENT DEVICE
PROVIDED

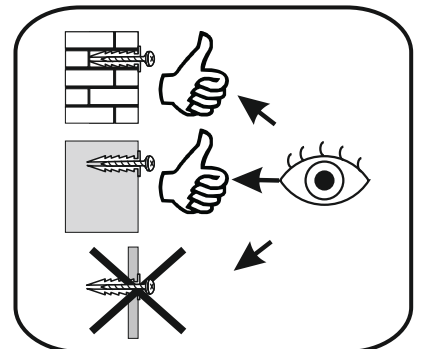
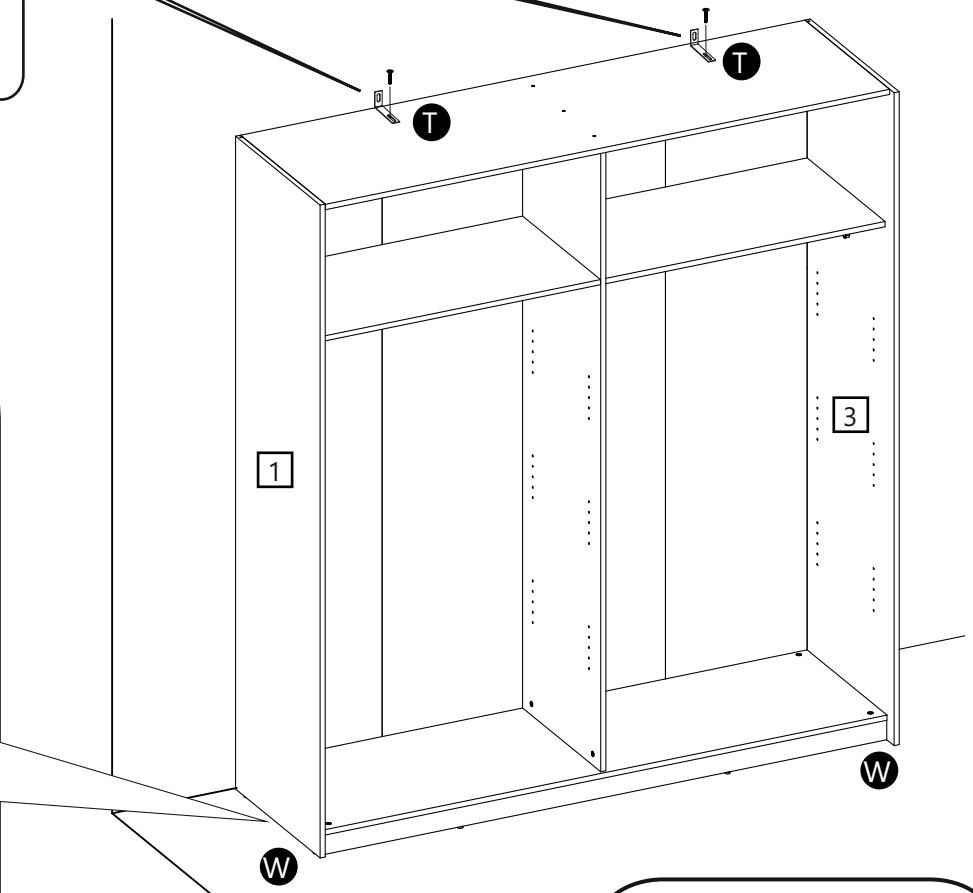
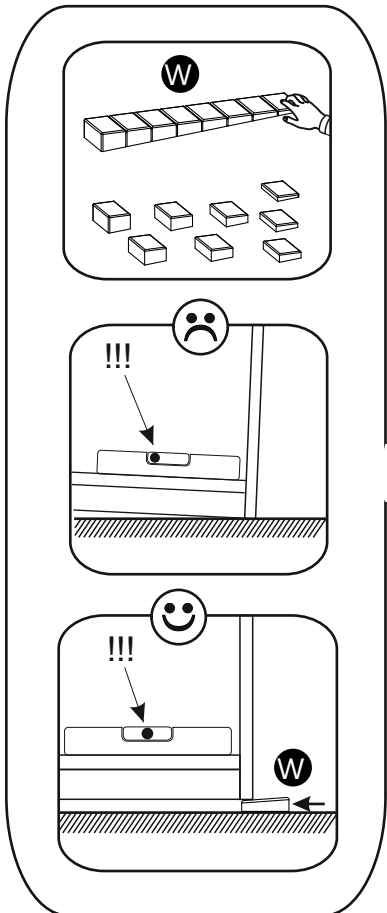
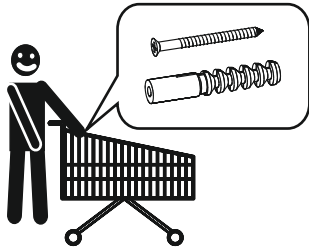
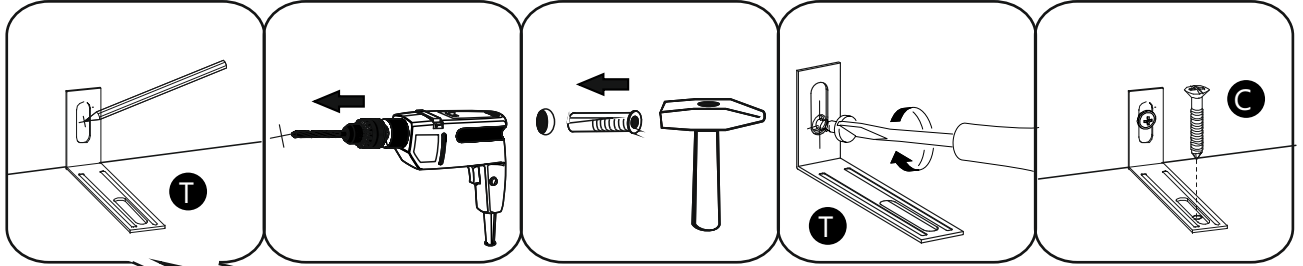

17

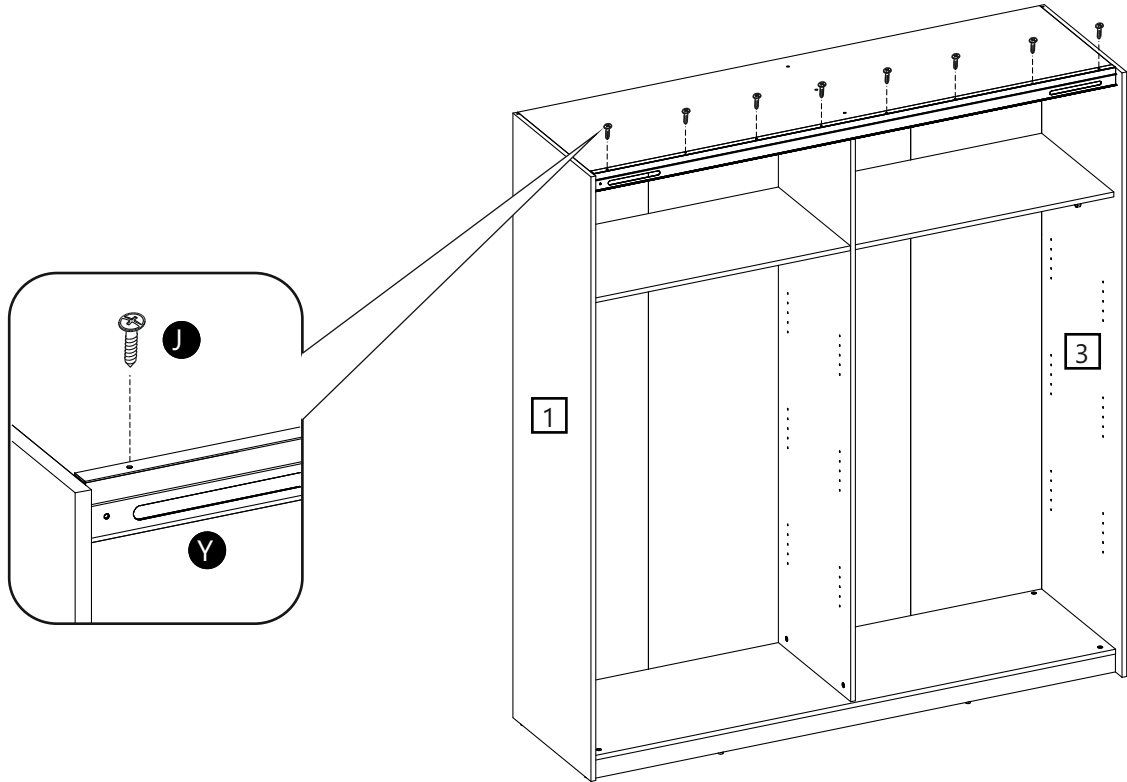
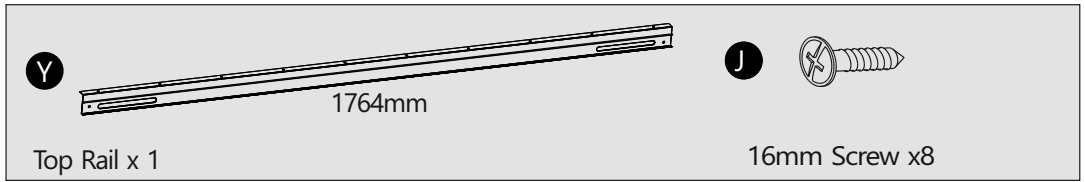

18

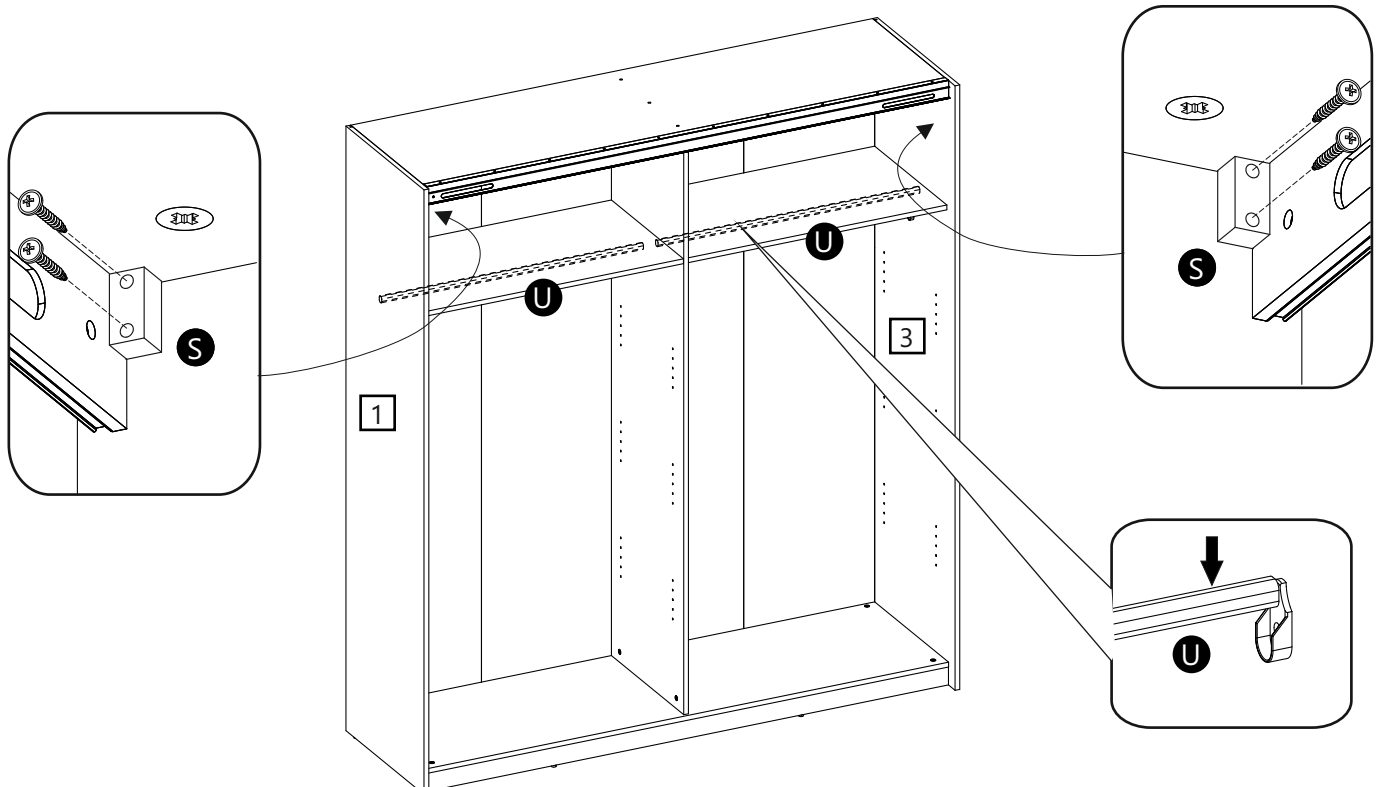

19

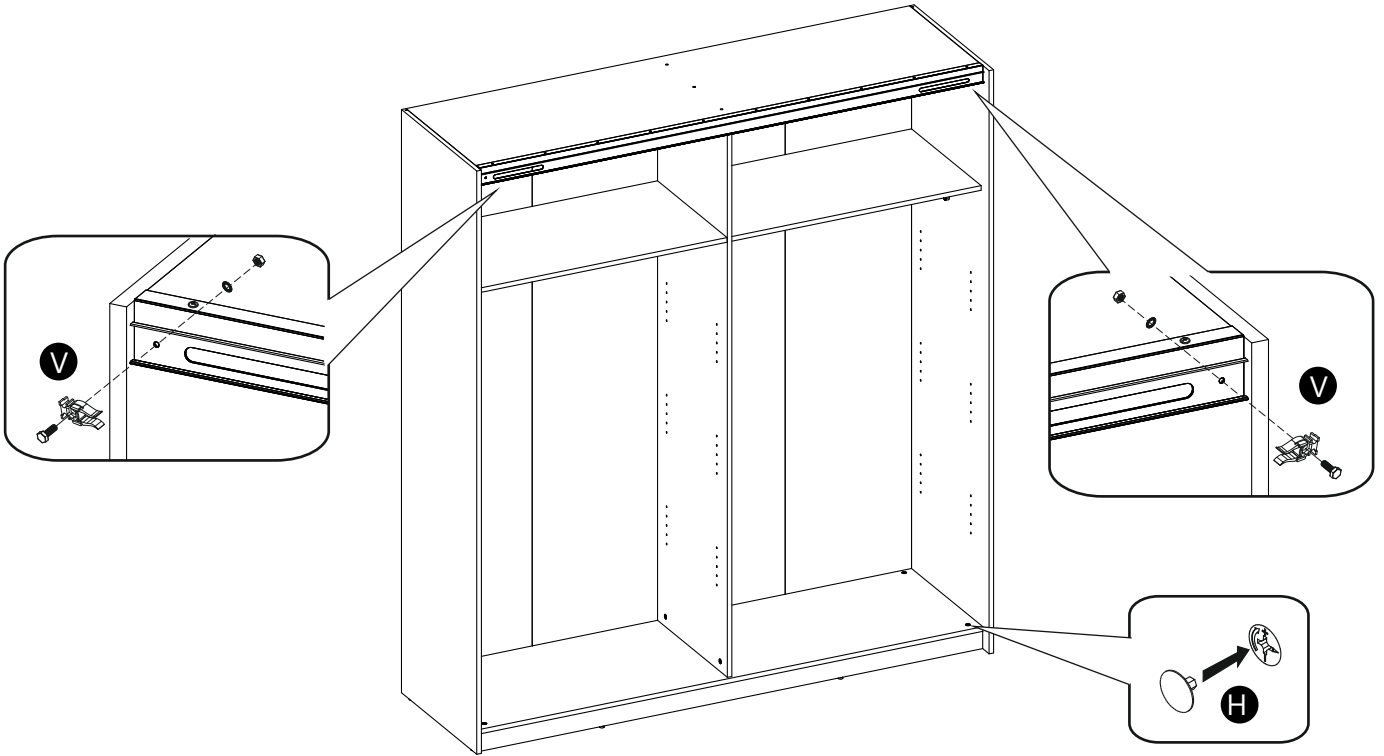
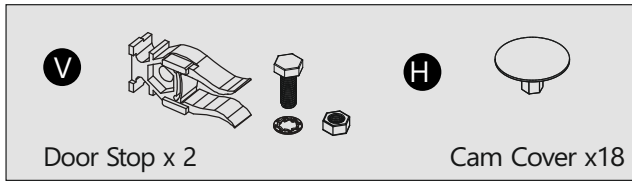

20

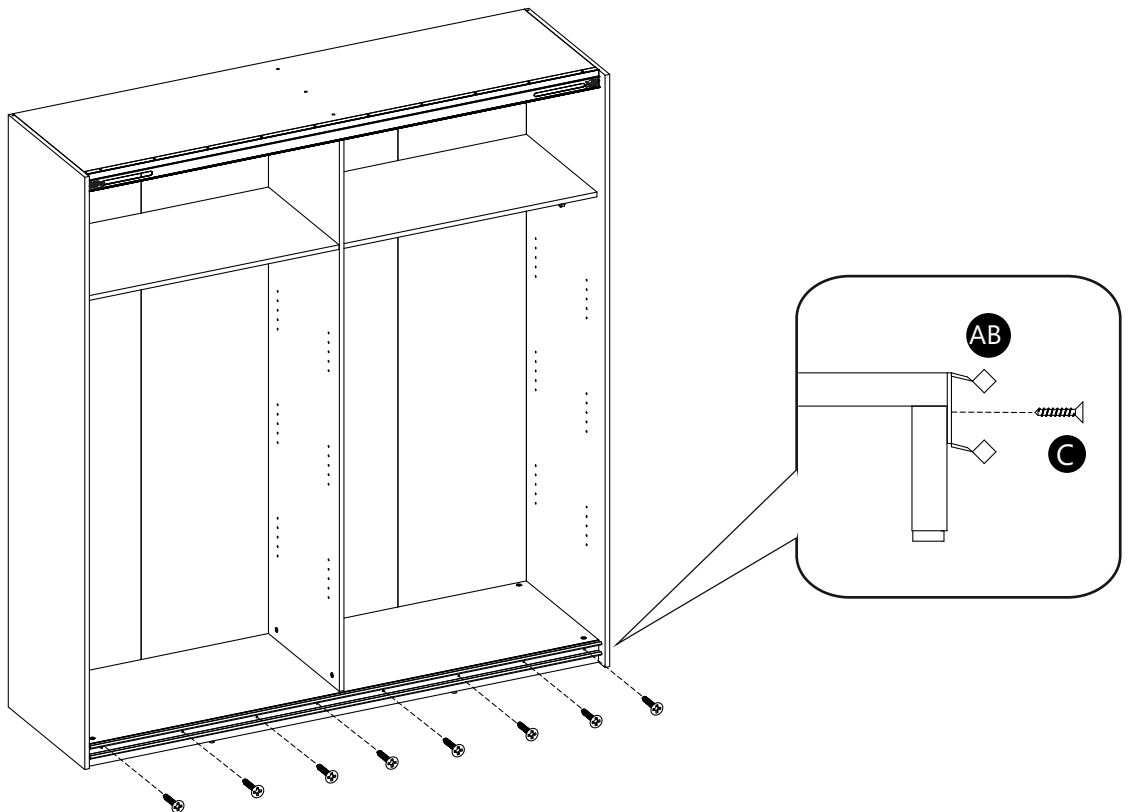
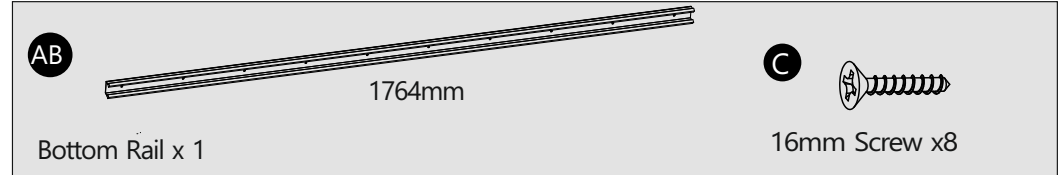

x2 Plain Doors
Pages 22>26

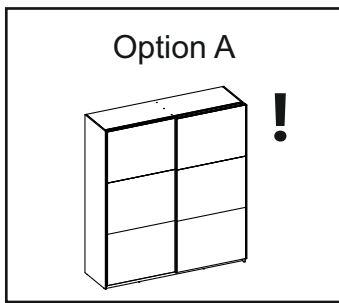

x1 Plain Door
x1 Mirror Door
Pages 27>32

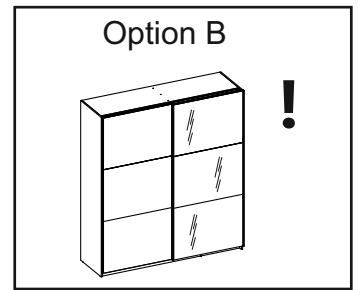

x2 Mirror Door
Pages 33>37

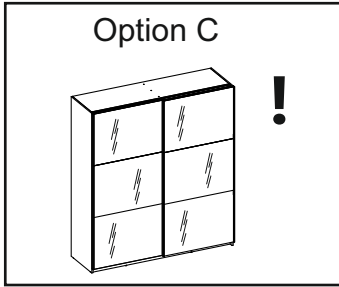

x2 Mirror Door
With Diamond Strip
Pages 38>42

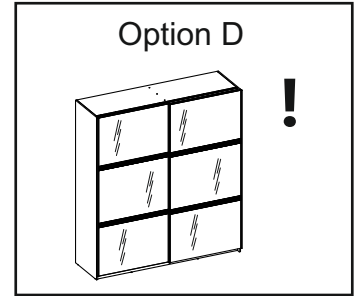

1

x2 Plain Doors
Pages 22>26

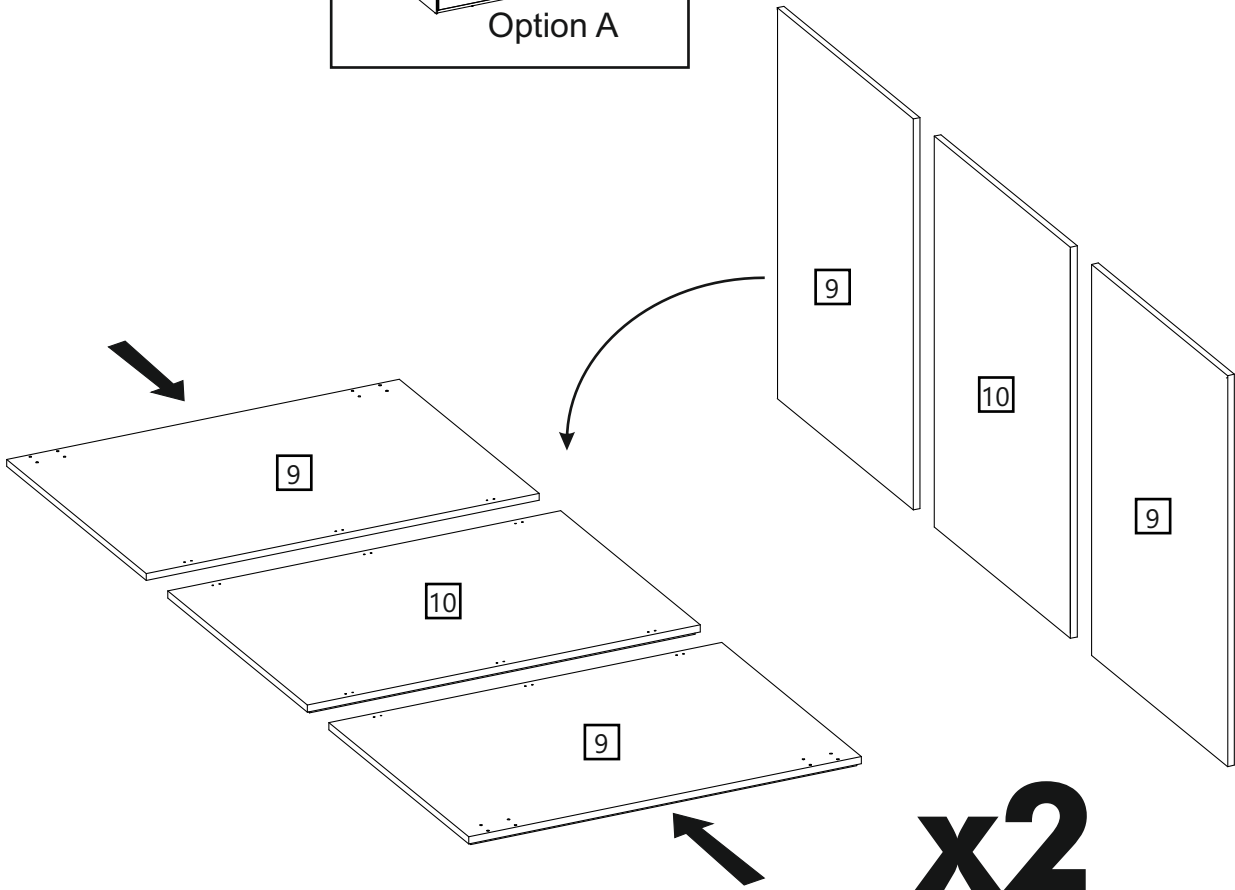
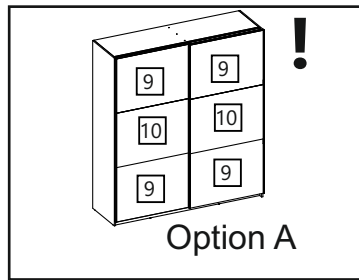

2

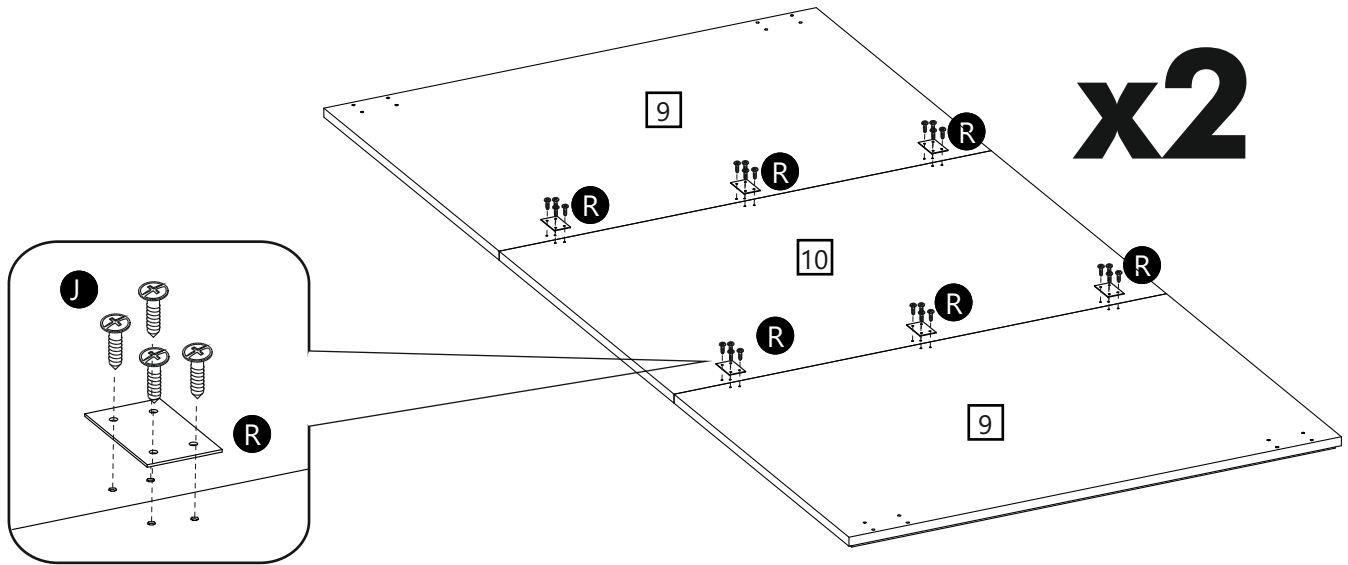
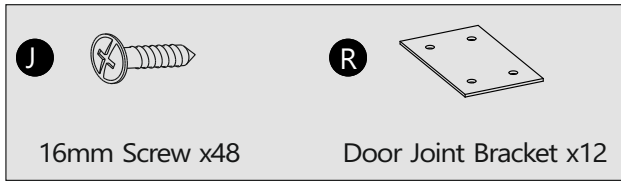

3

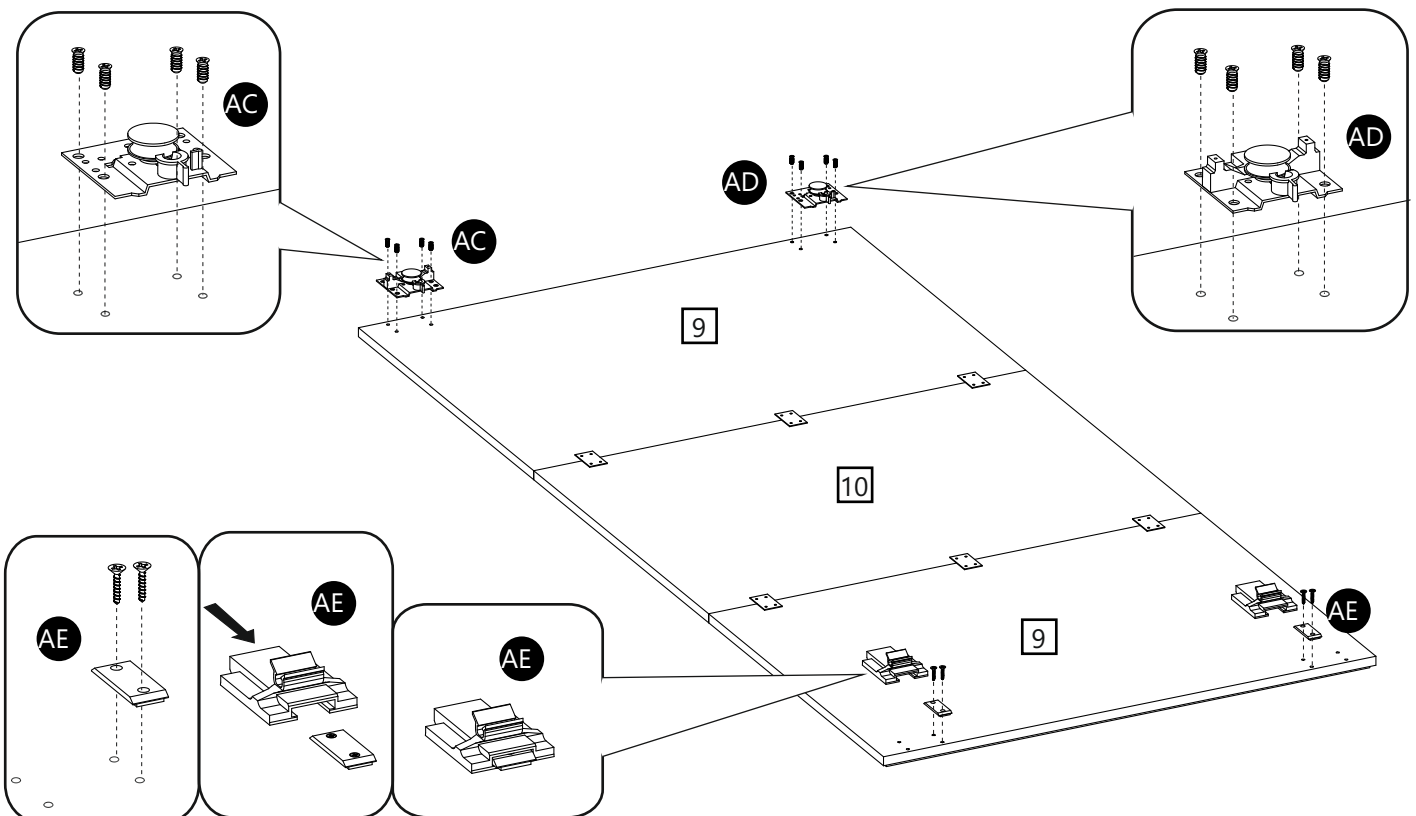
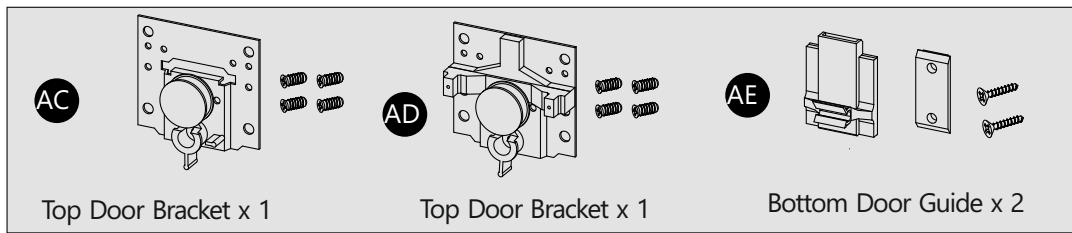

4

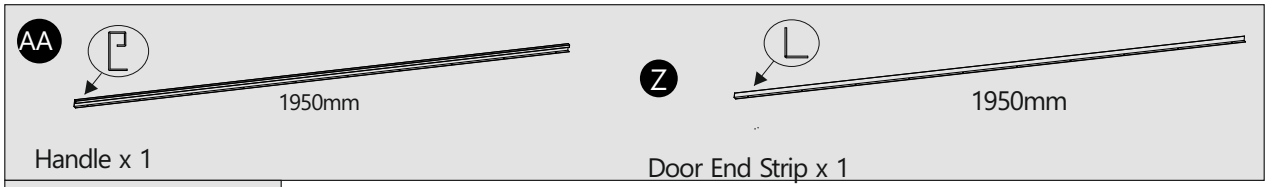

Please, remove protective cover before fitting.

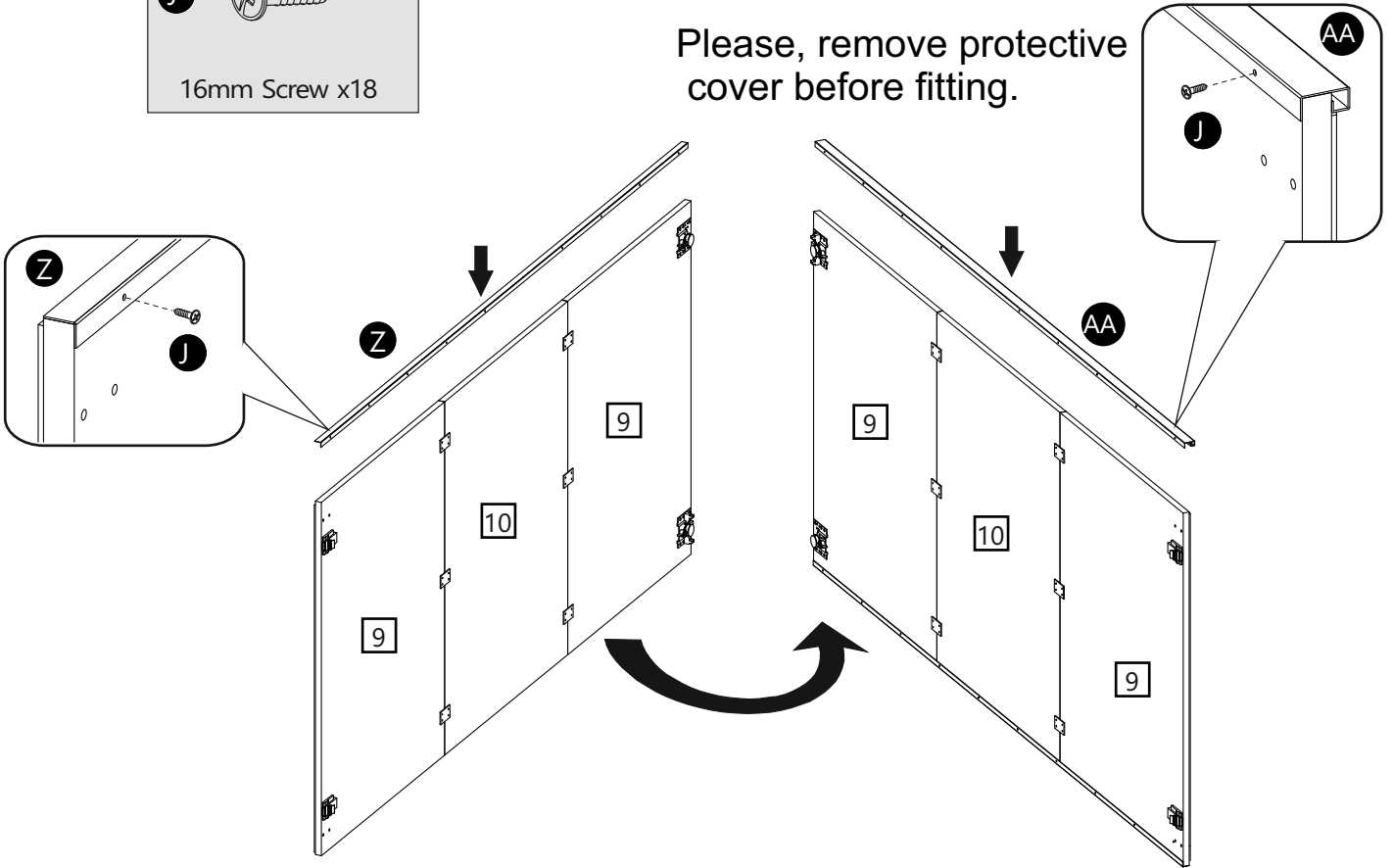

5

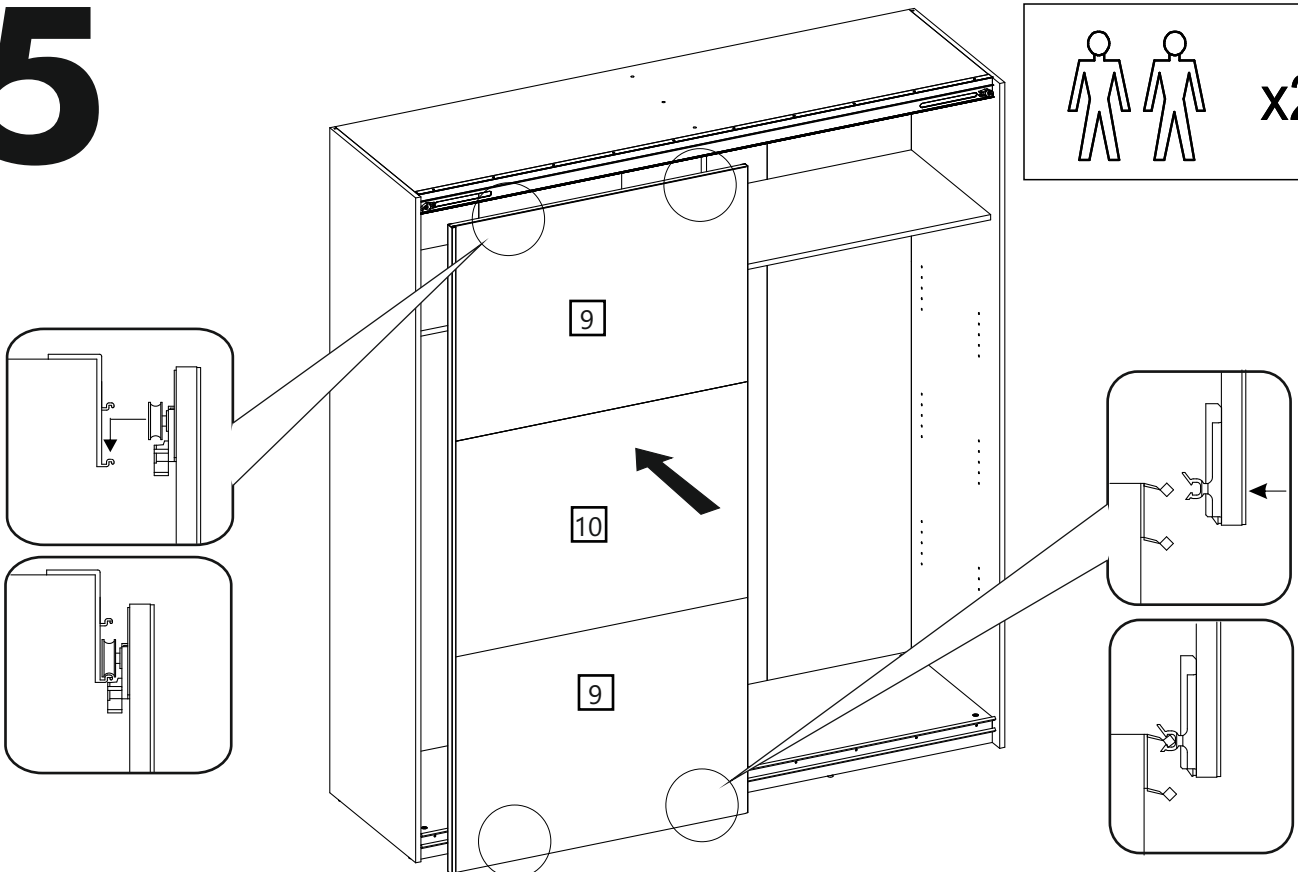
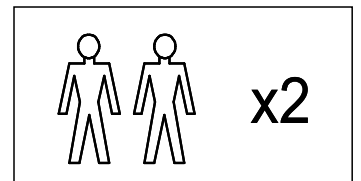

6

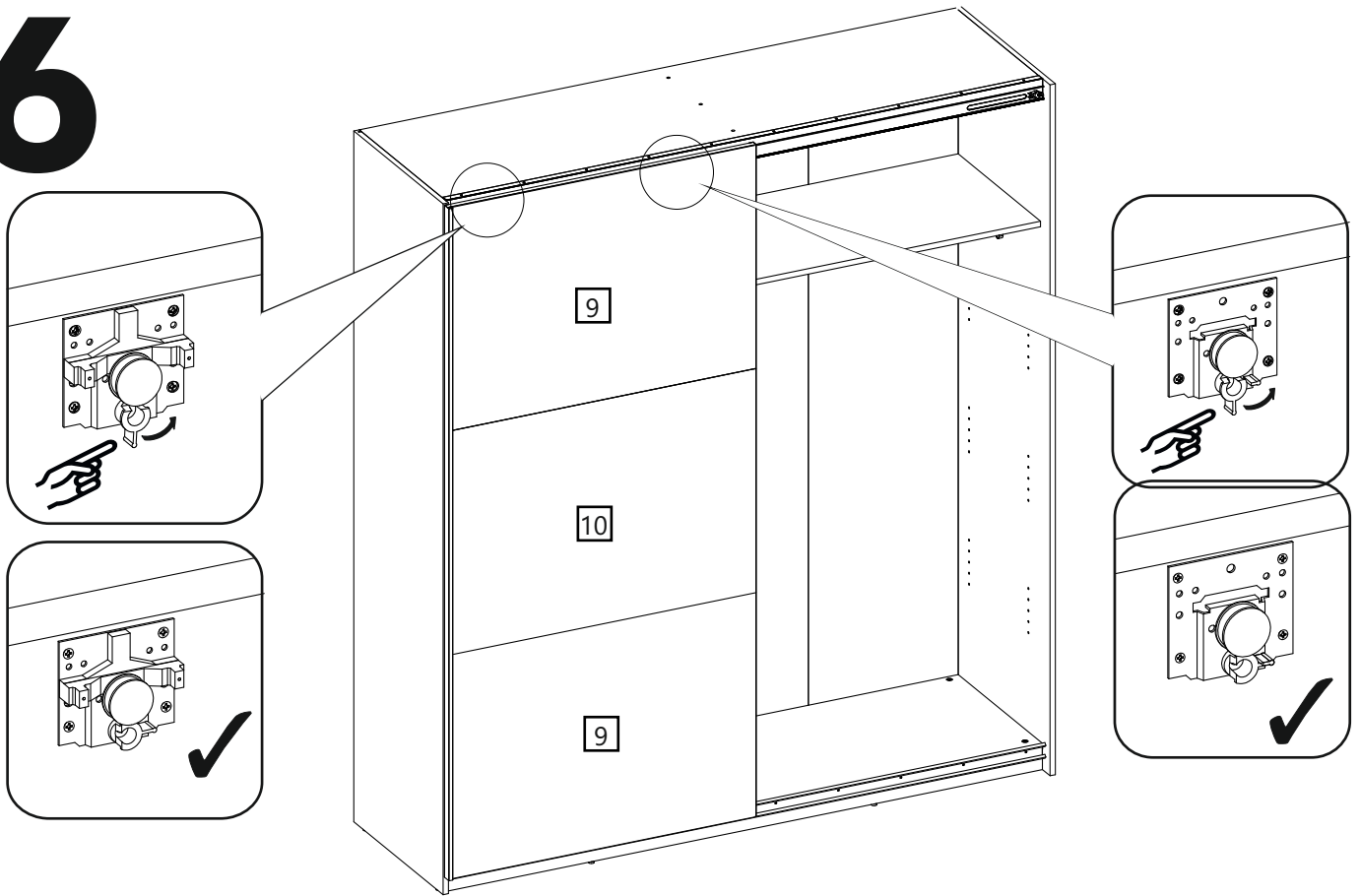

7

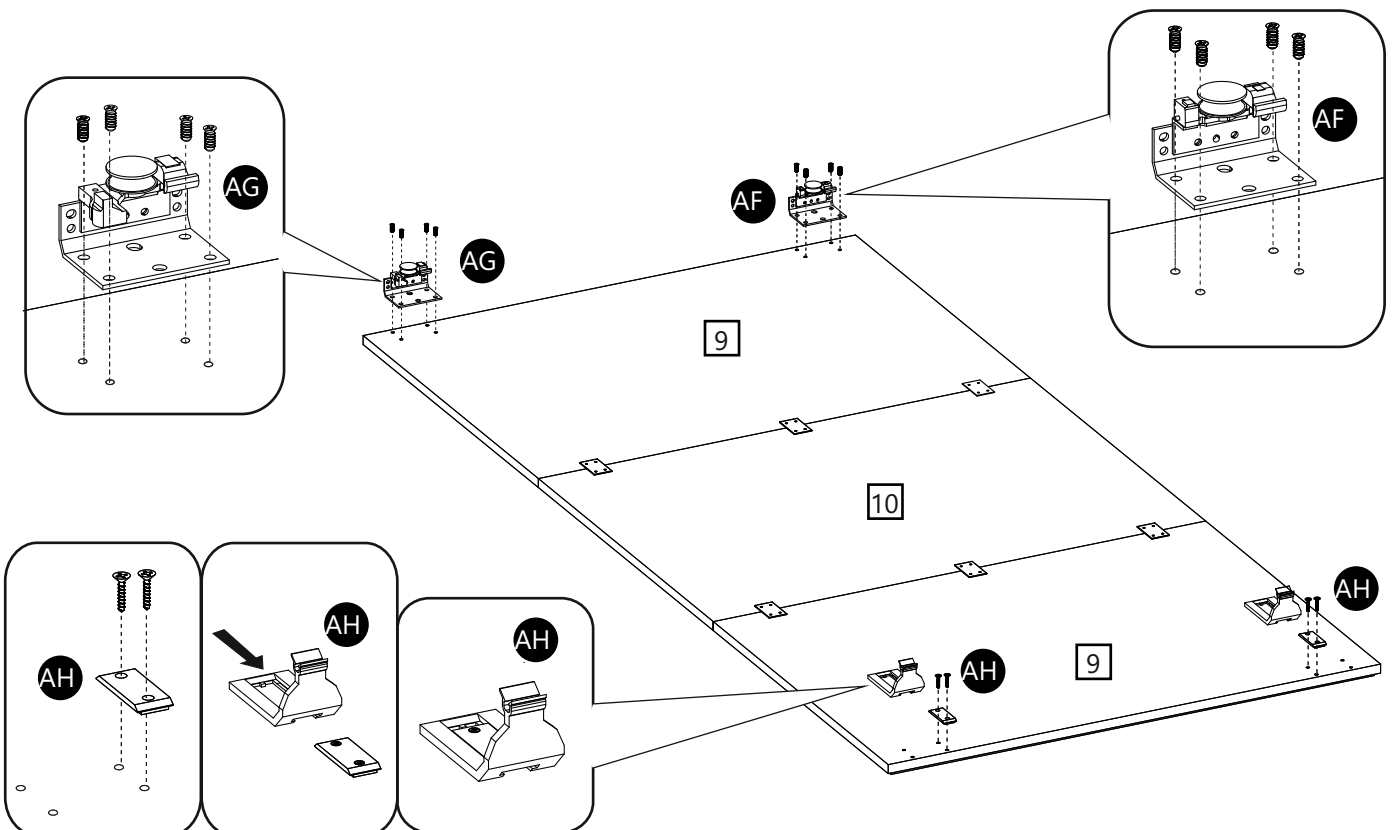
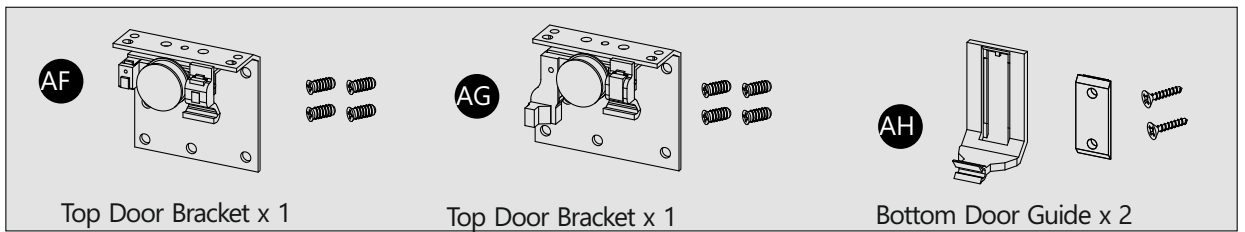

8

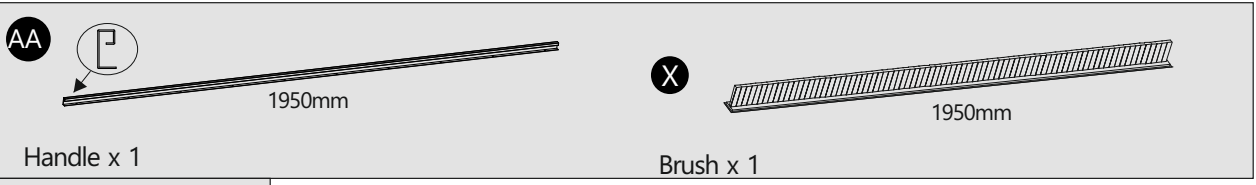

Please, remove protective cover before fitting.

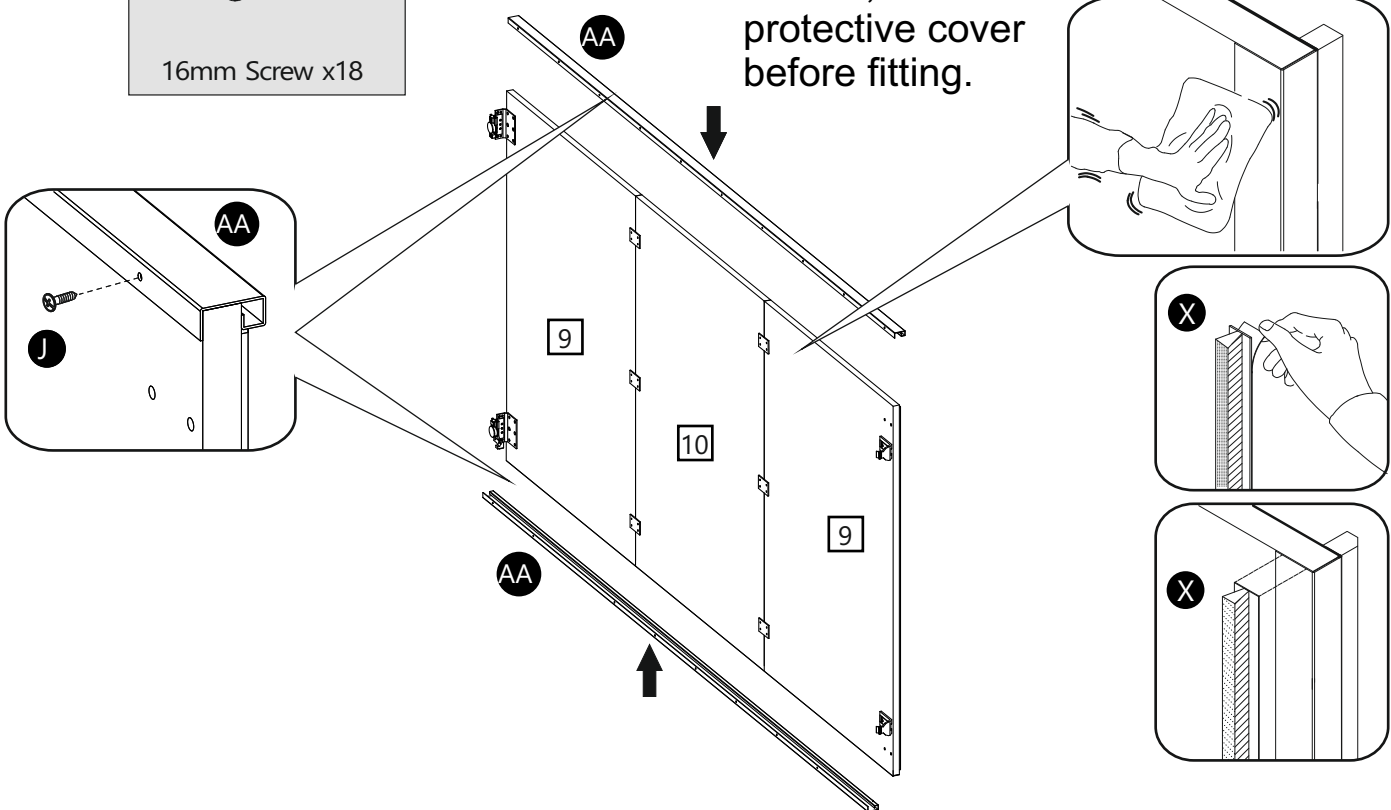

9

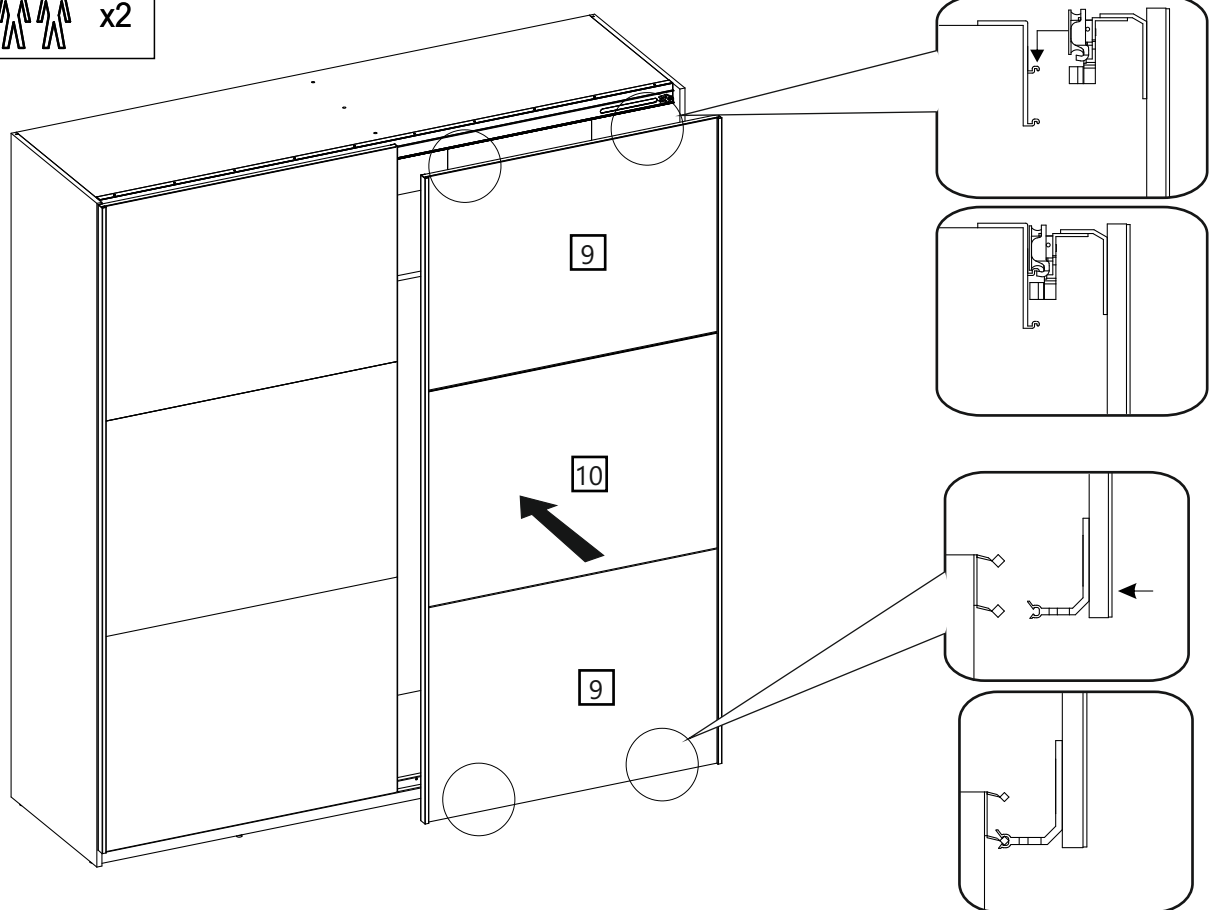

x1 Plain Door
x1 Mirror Door
Pages 27>32

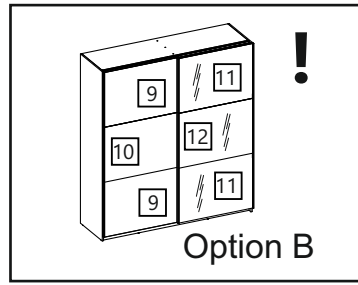

1

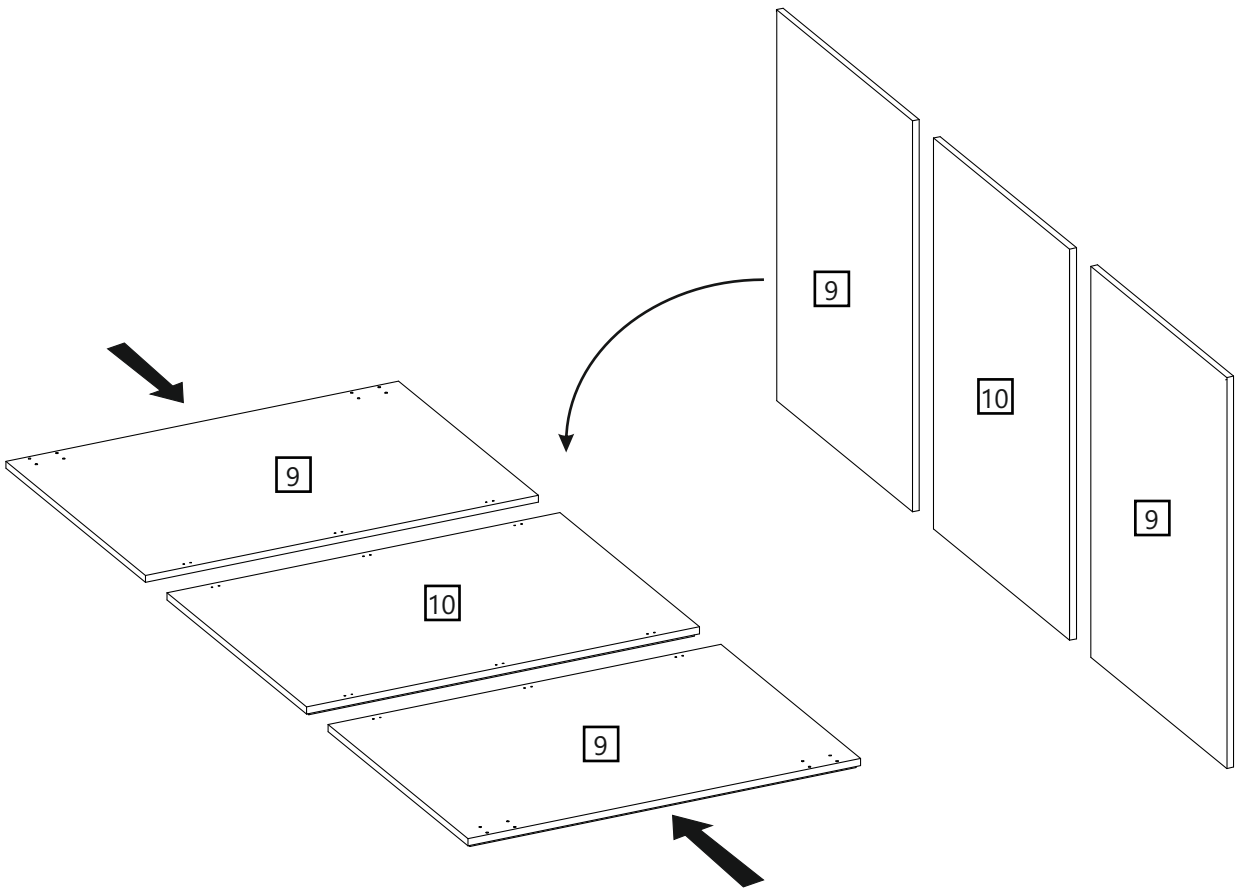

2

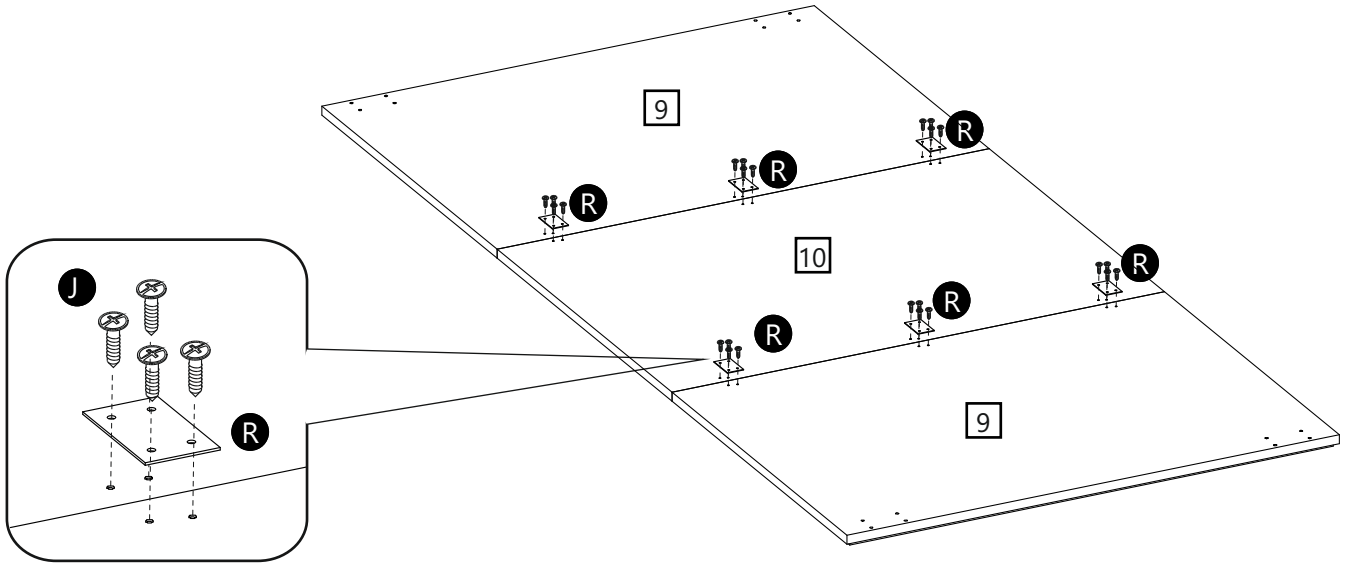
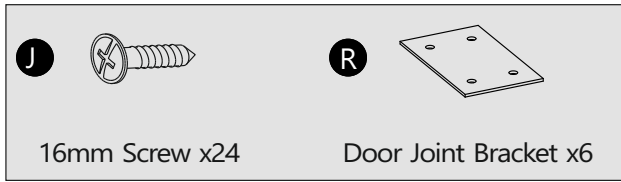

3

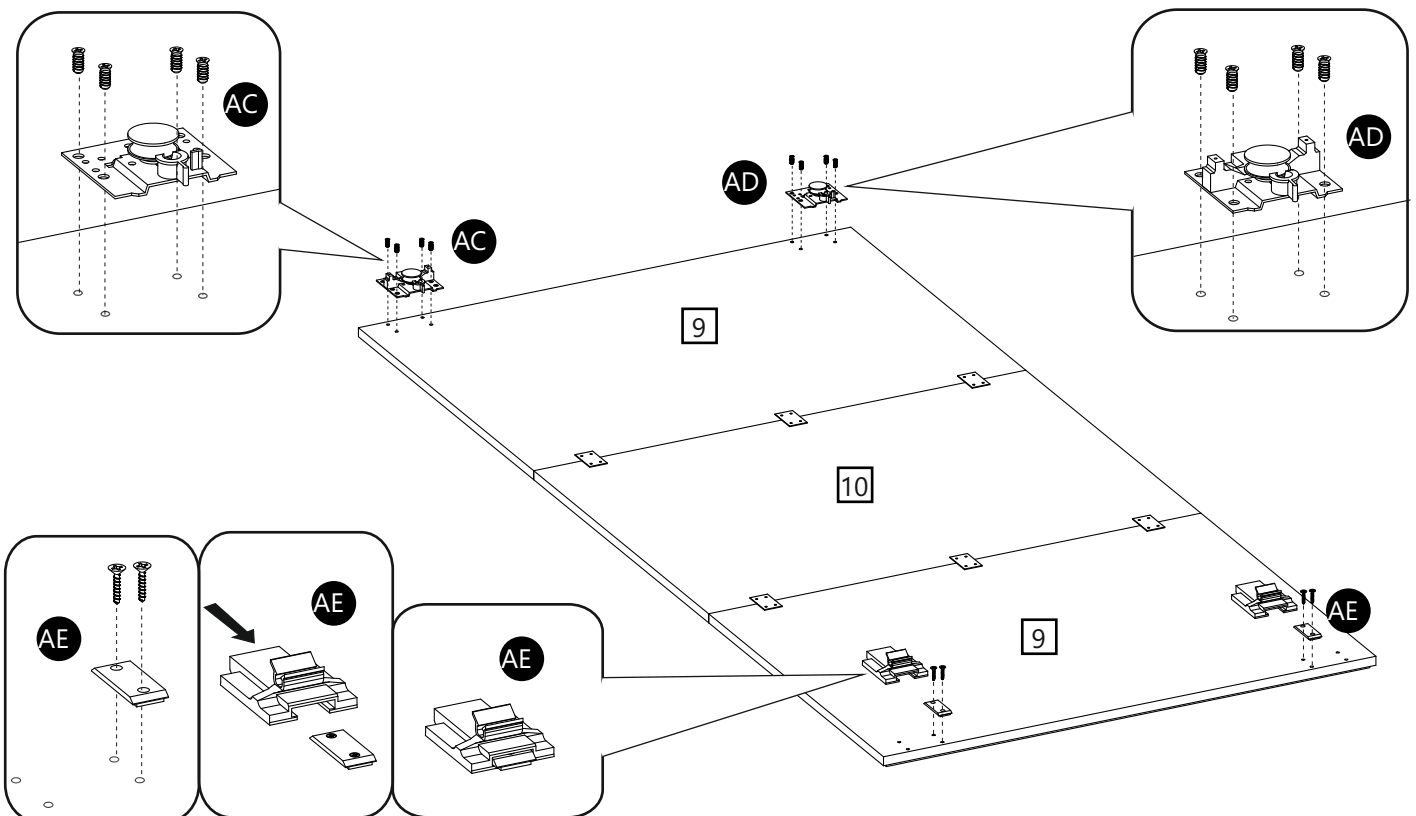
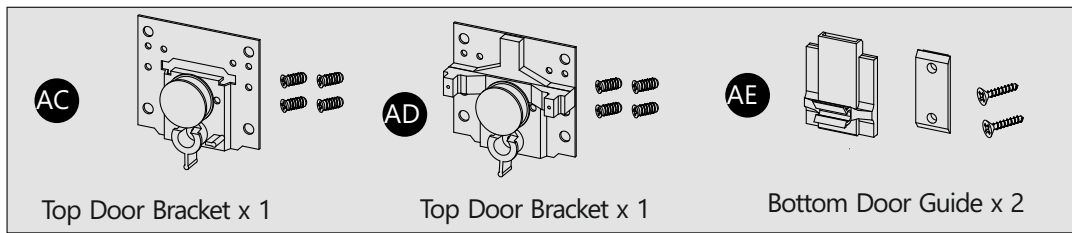

4

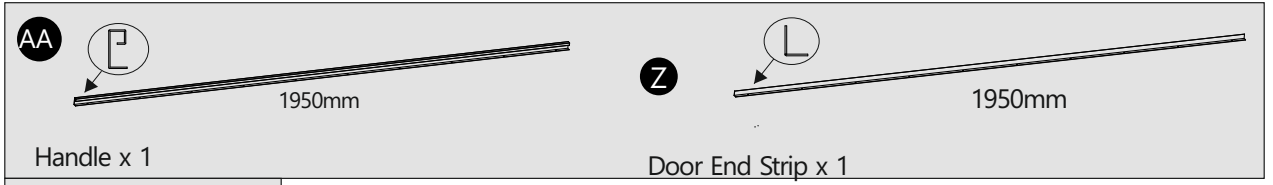

Please, remove protective cover before fitting.

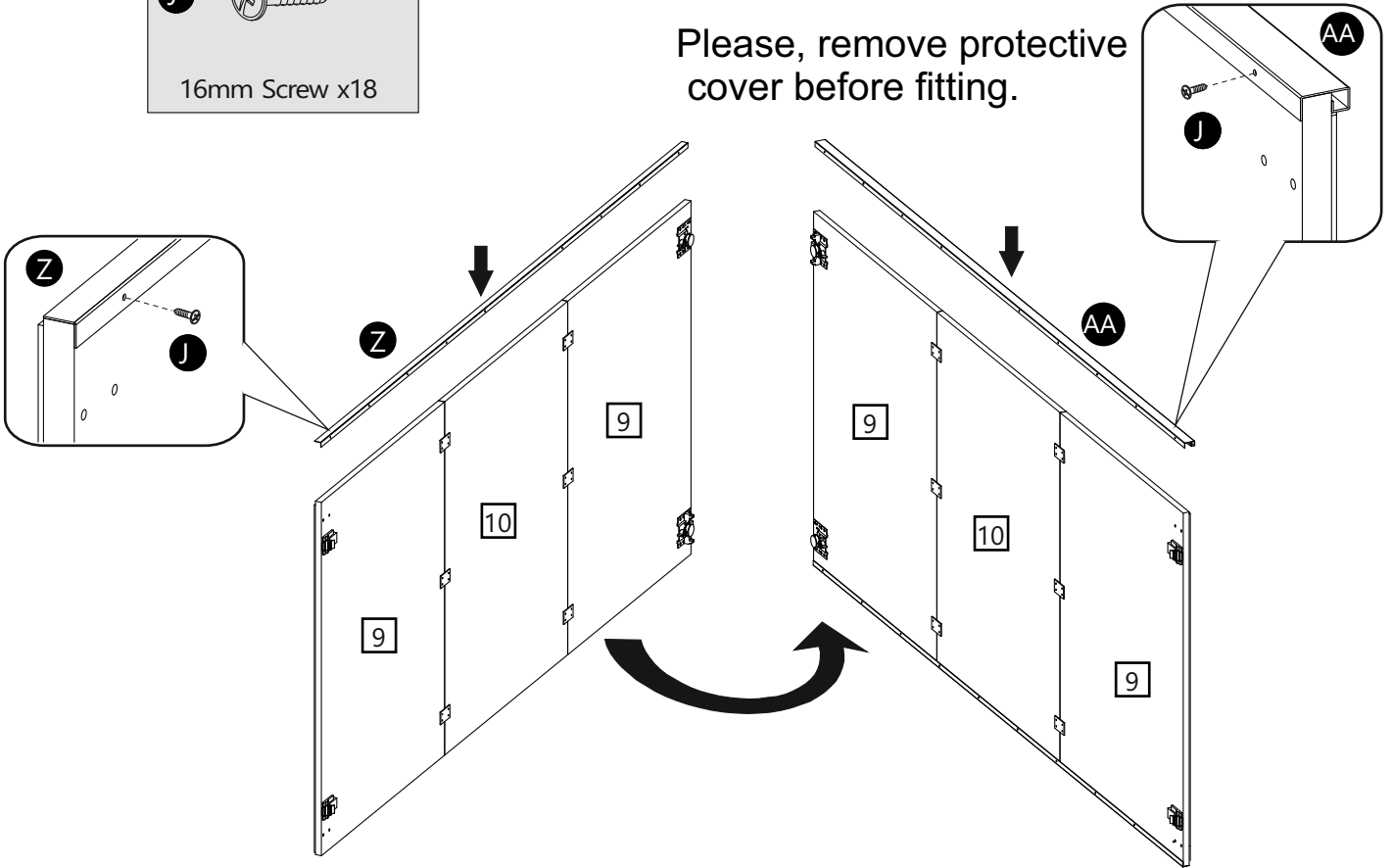

5

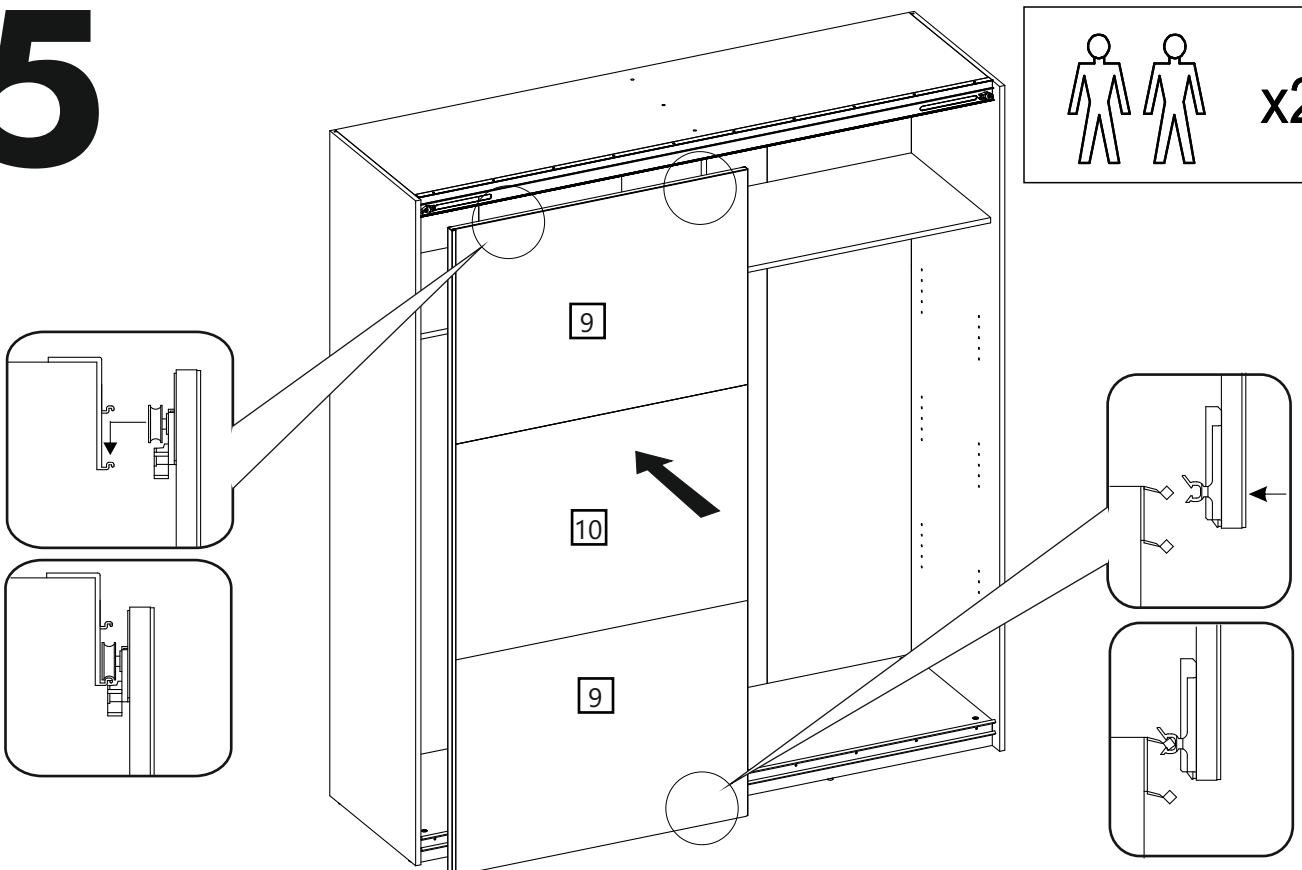
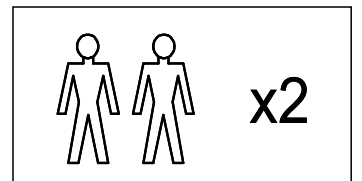

6

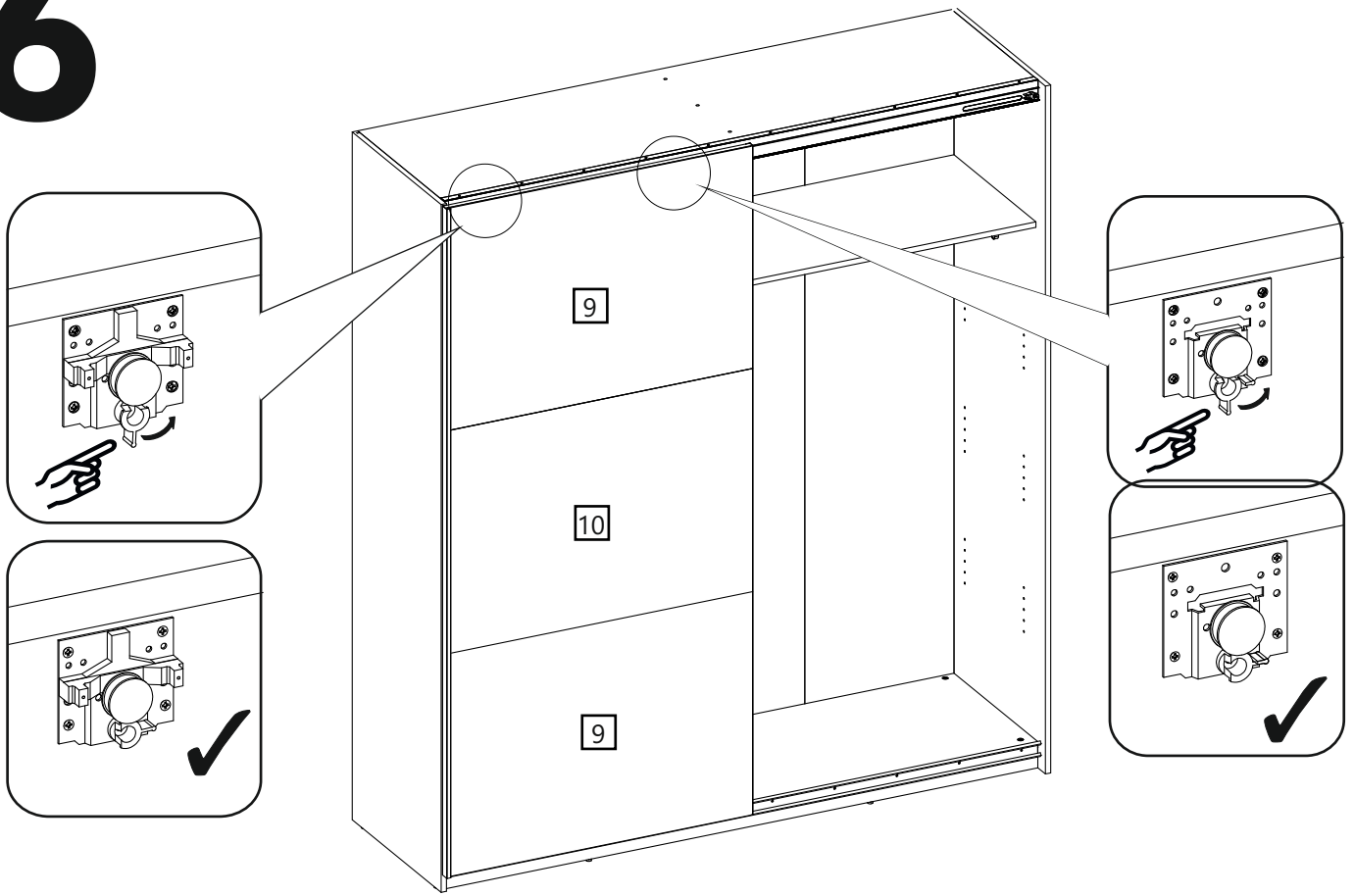

7

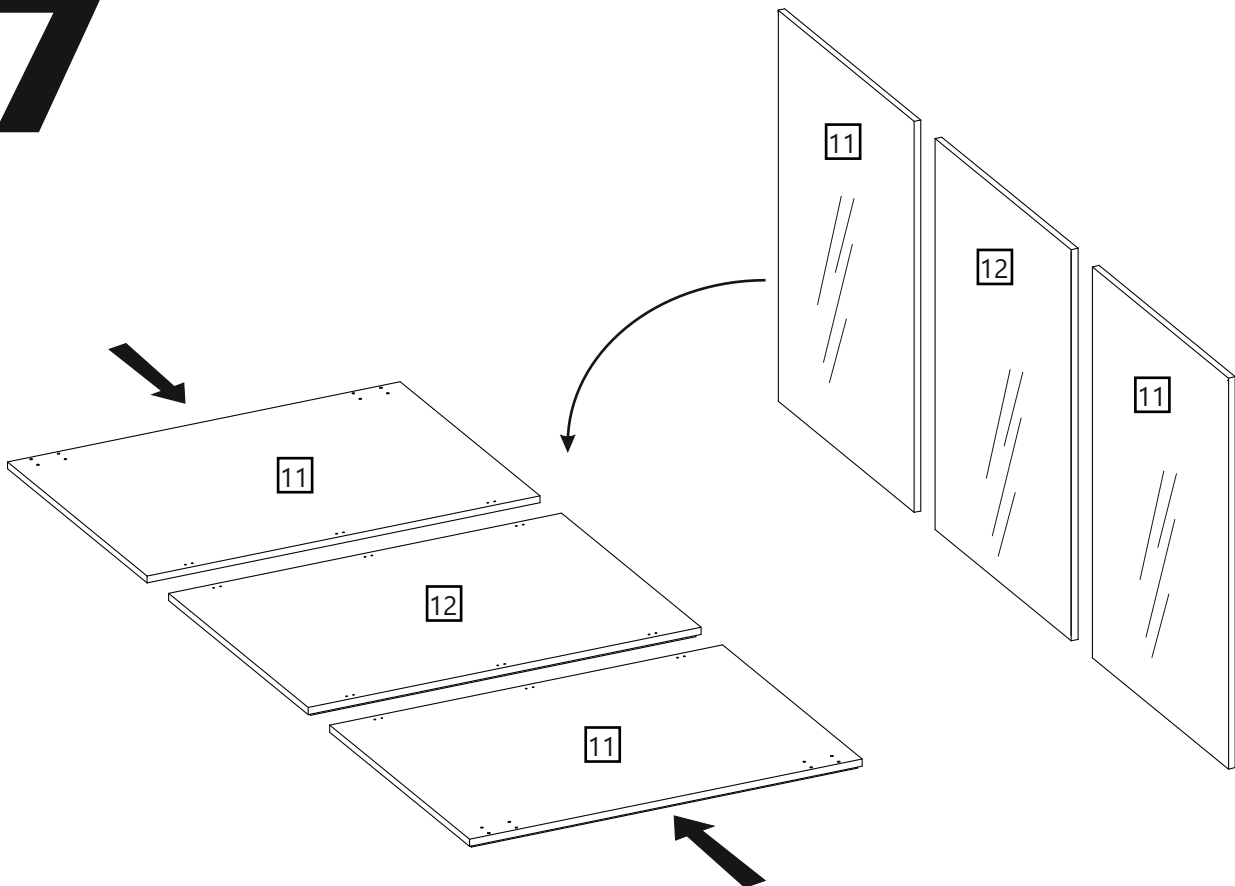

8

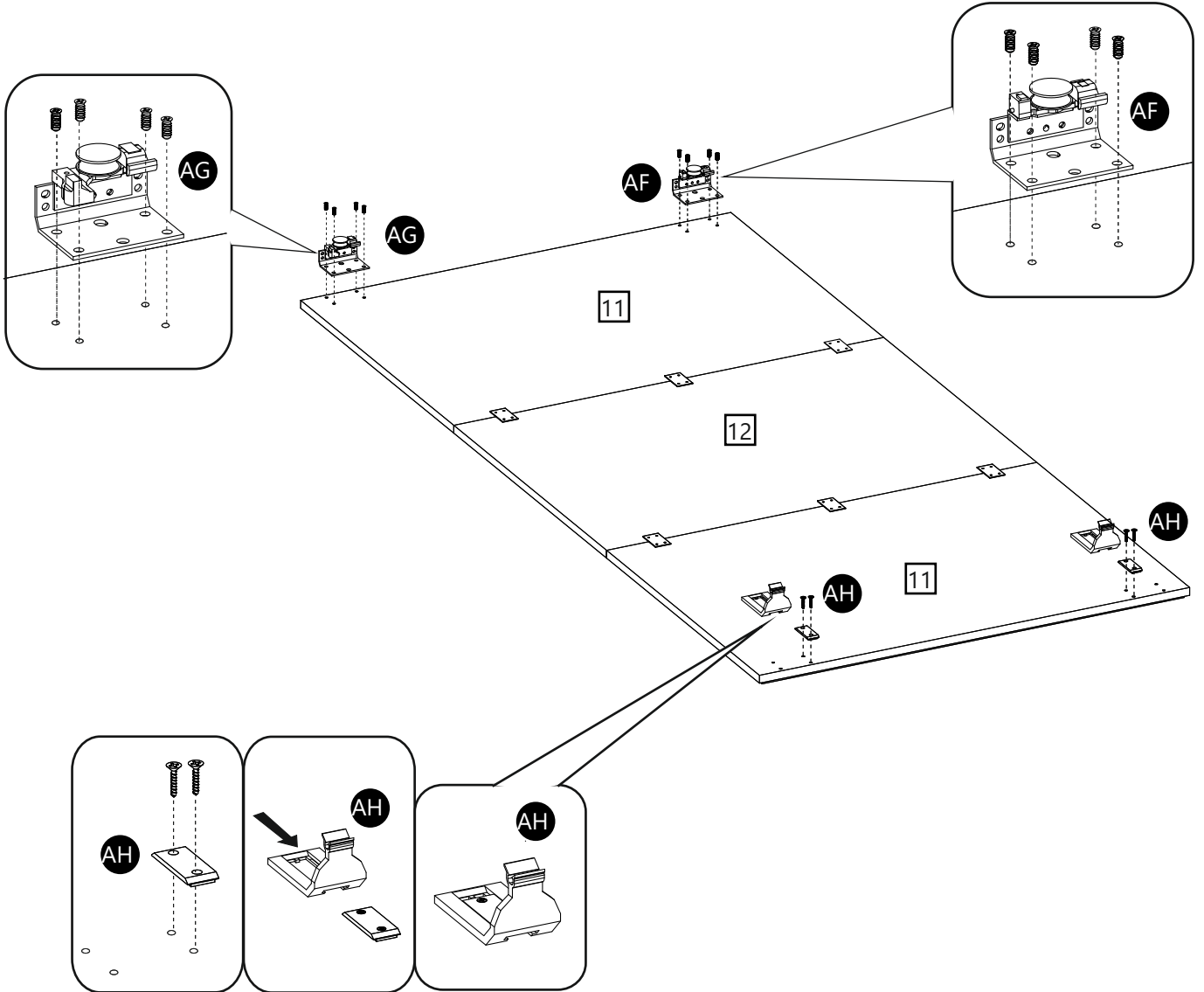
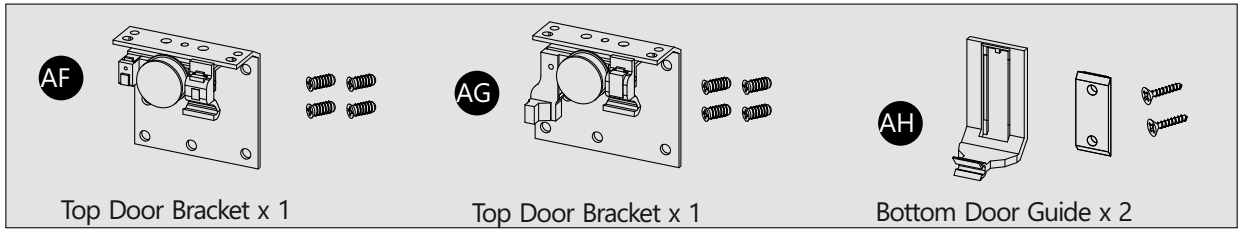

9

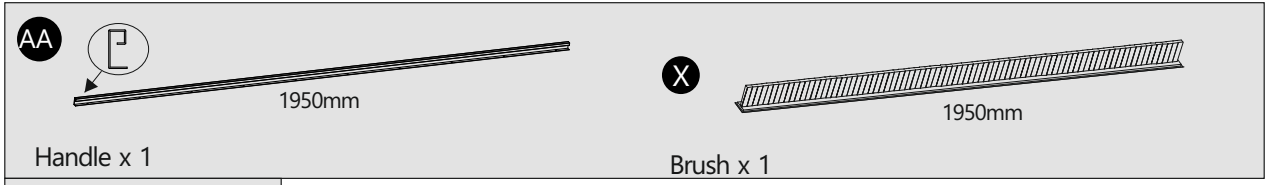

Please, remove protective cover before fitting.

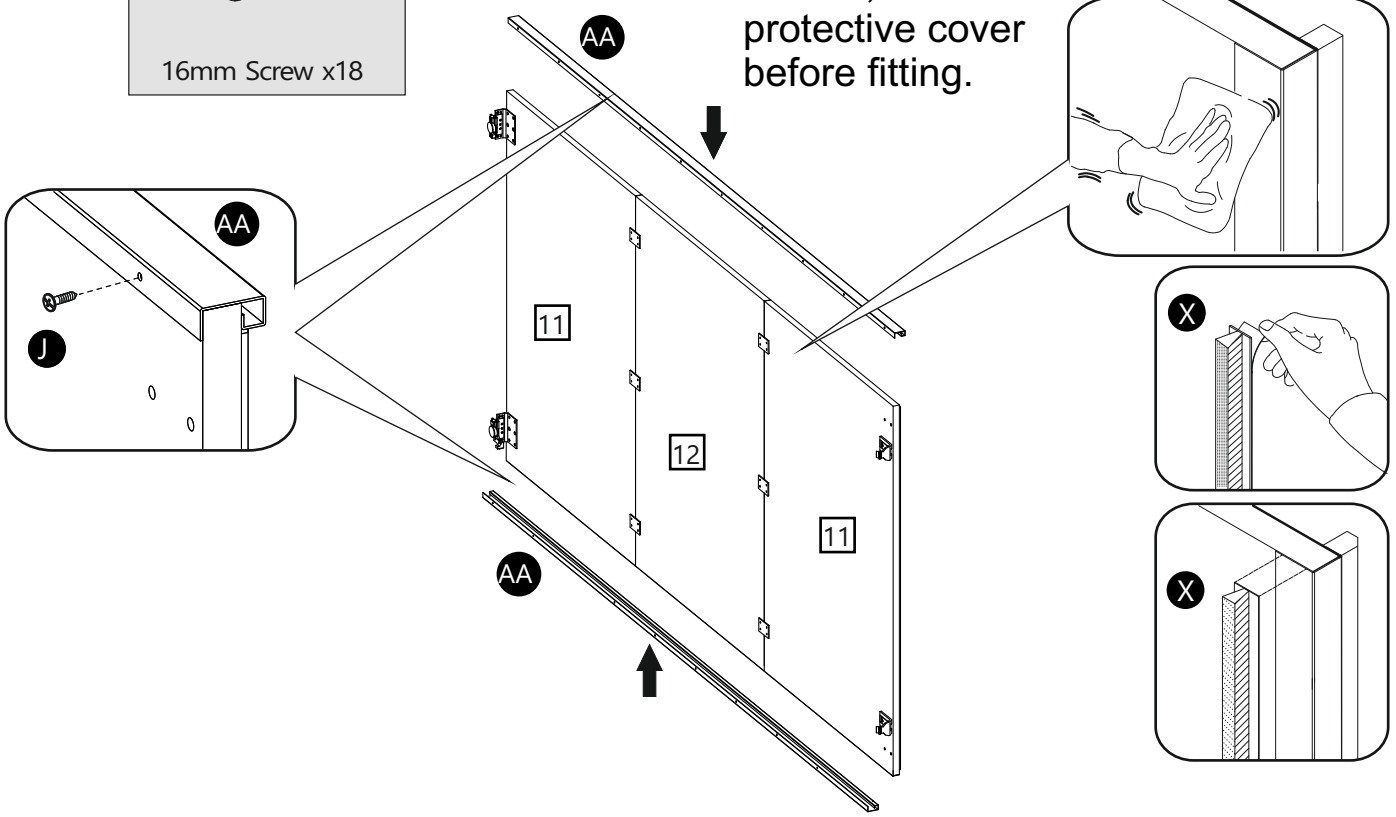

10

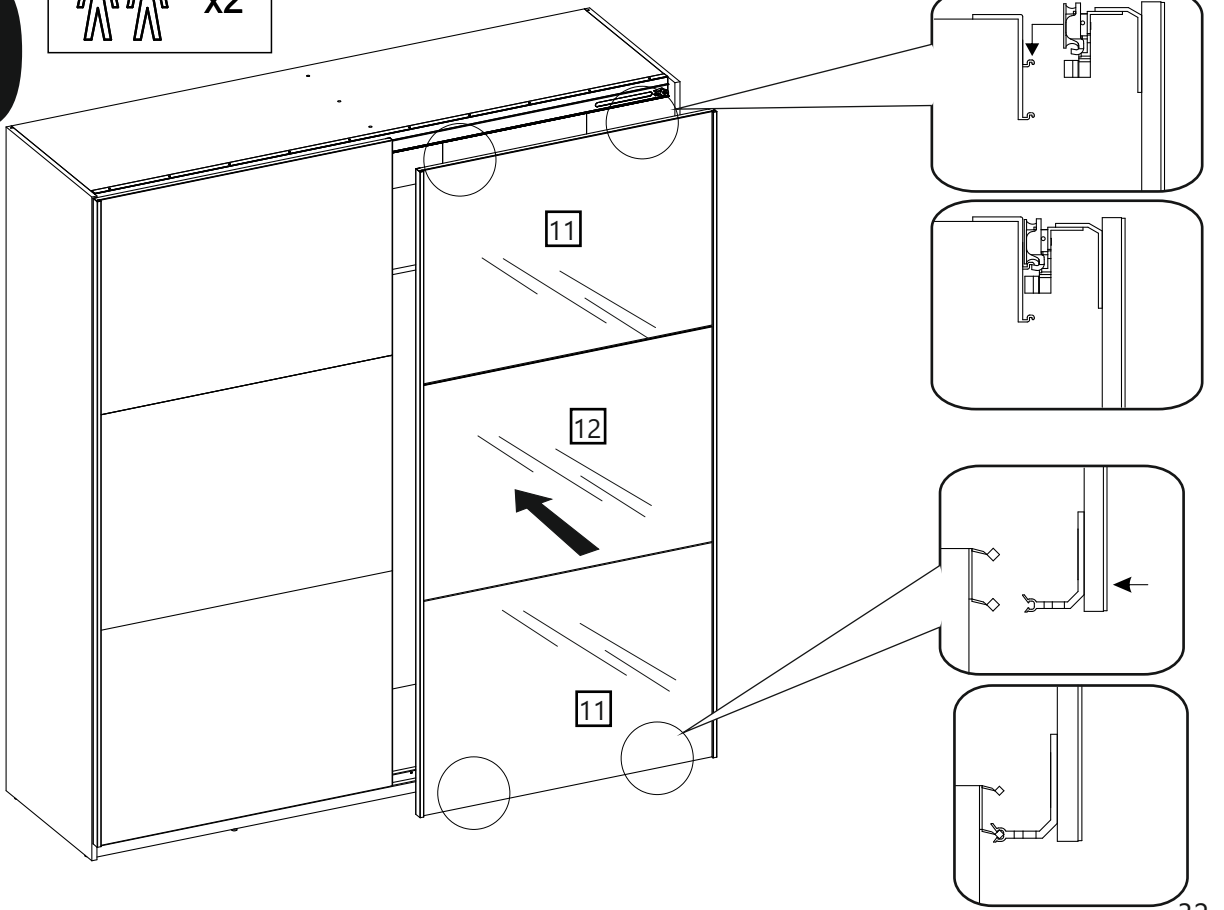
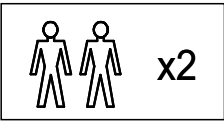

Mirror Door
Pages 33>37

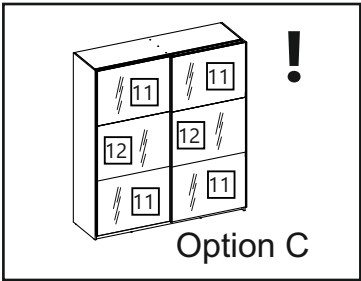

1

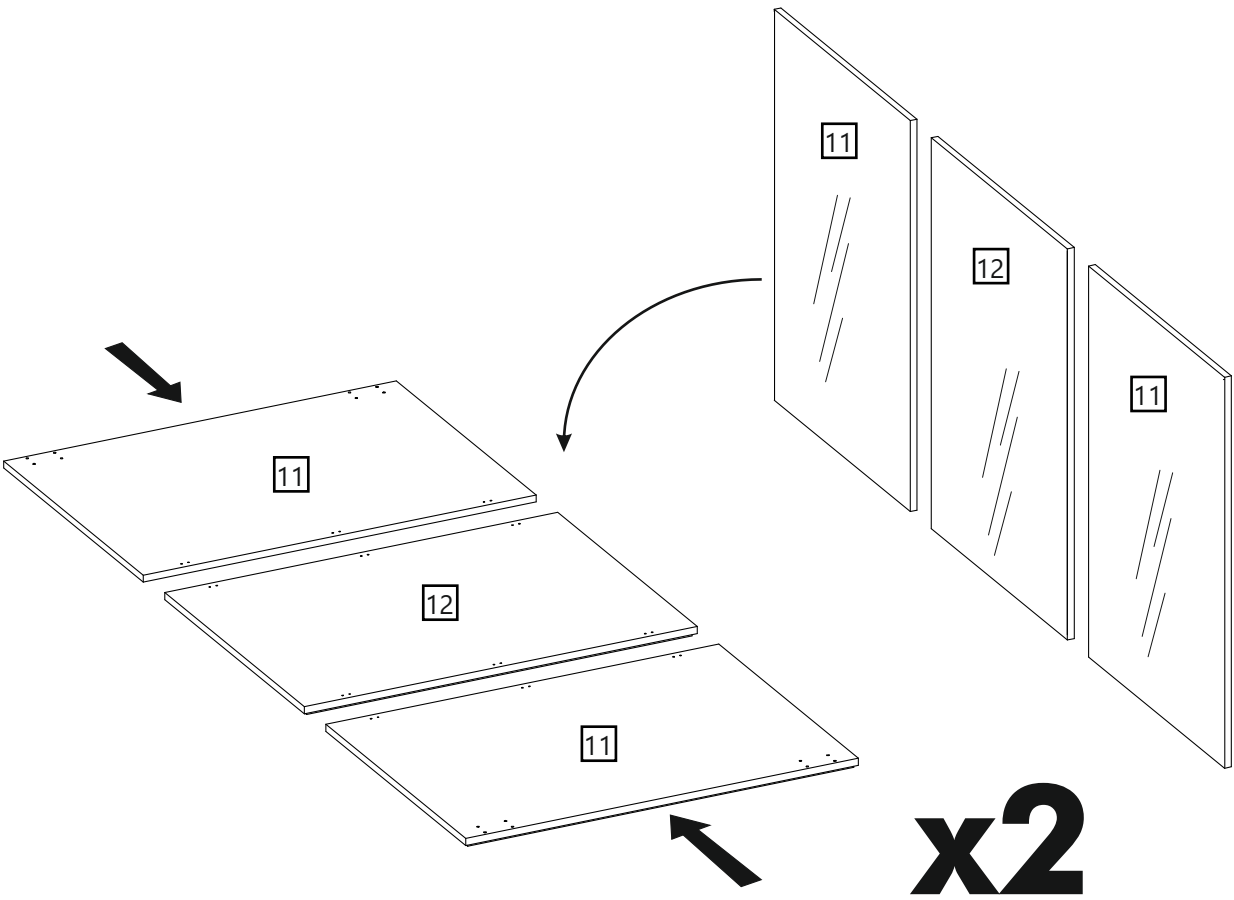

2

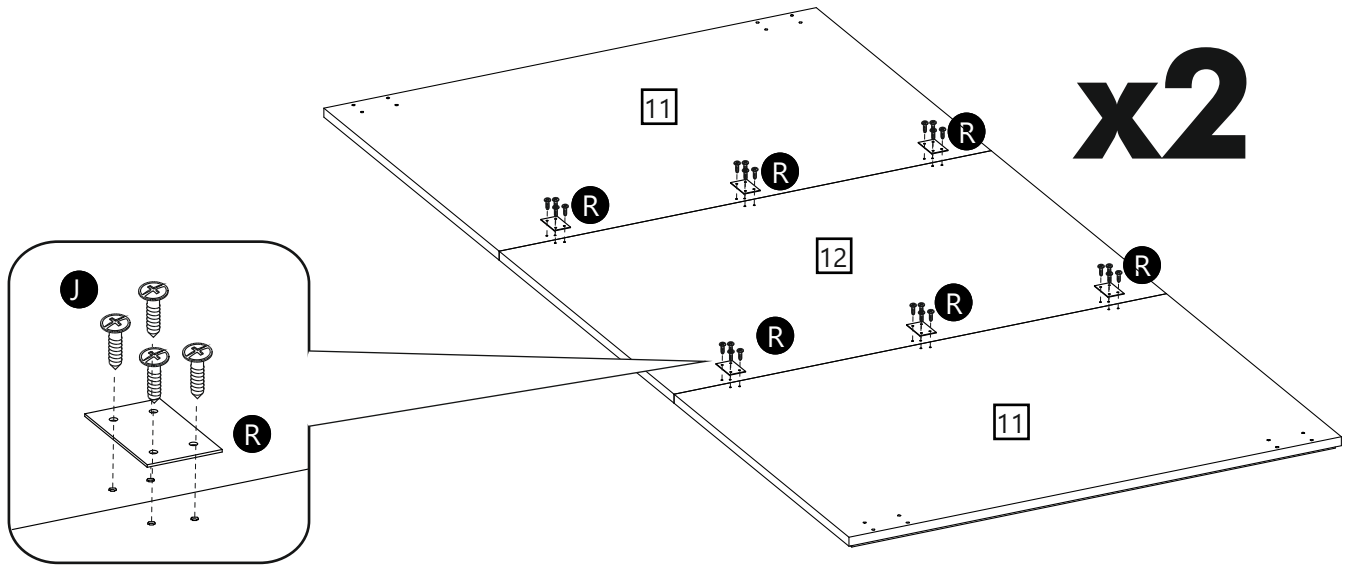
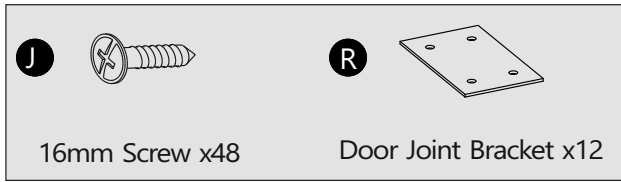

3

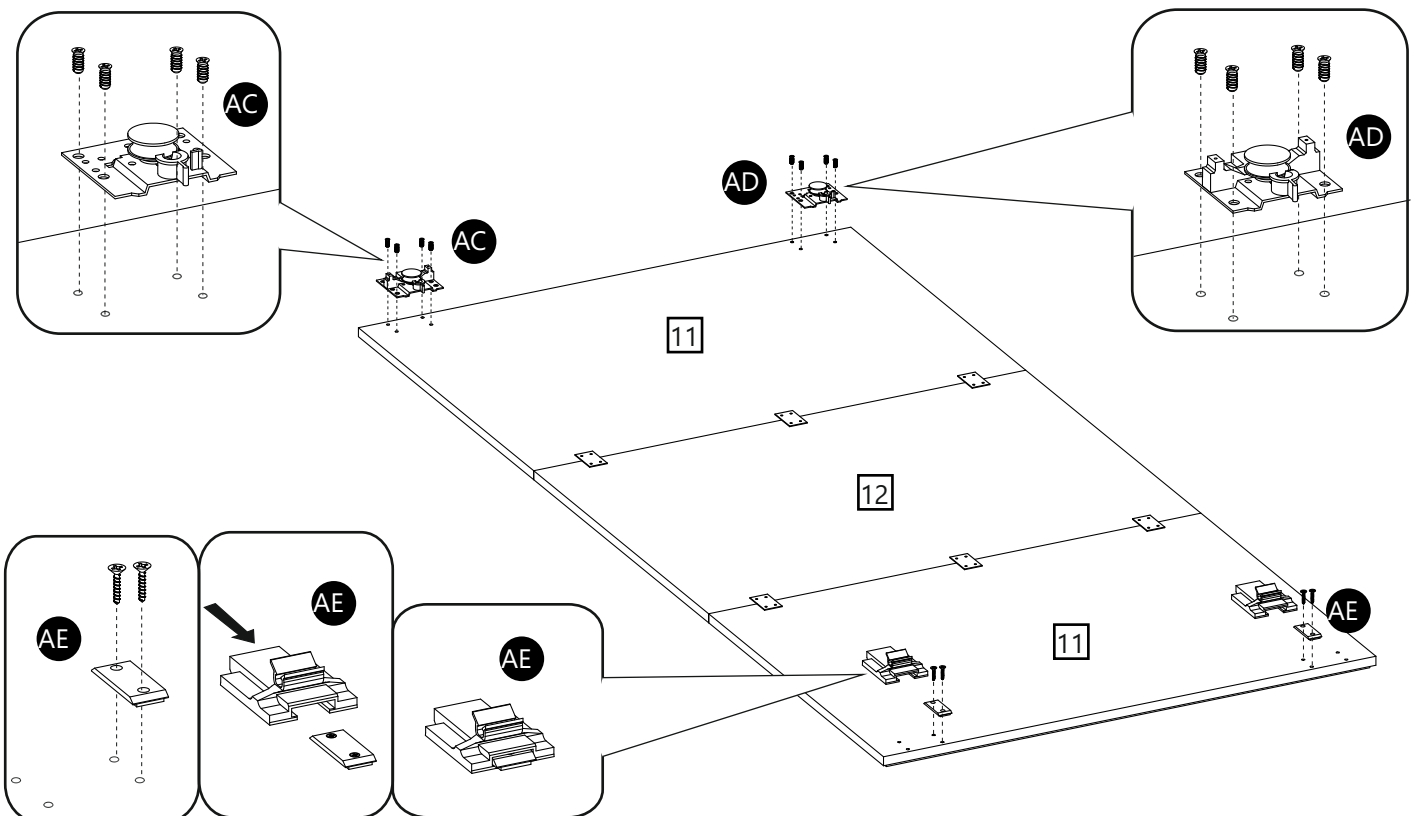
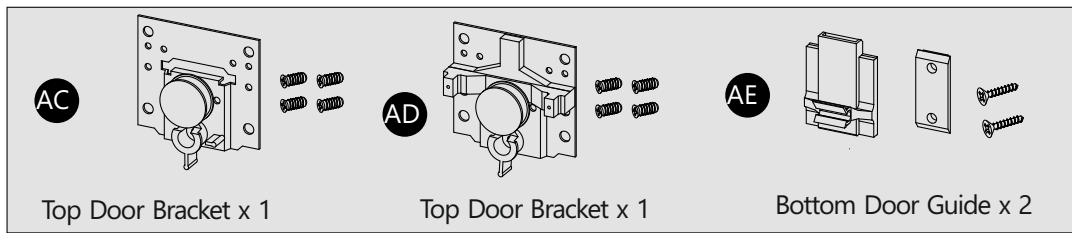

4

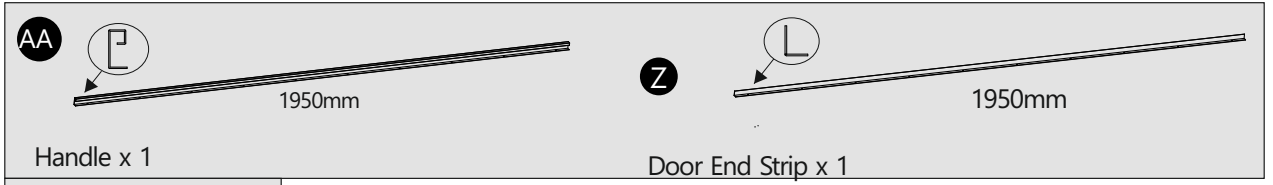

Please, remove protective cover before fitting.

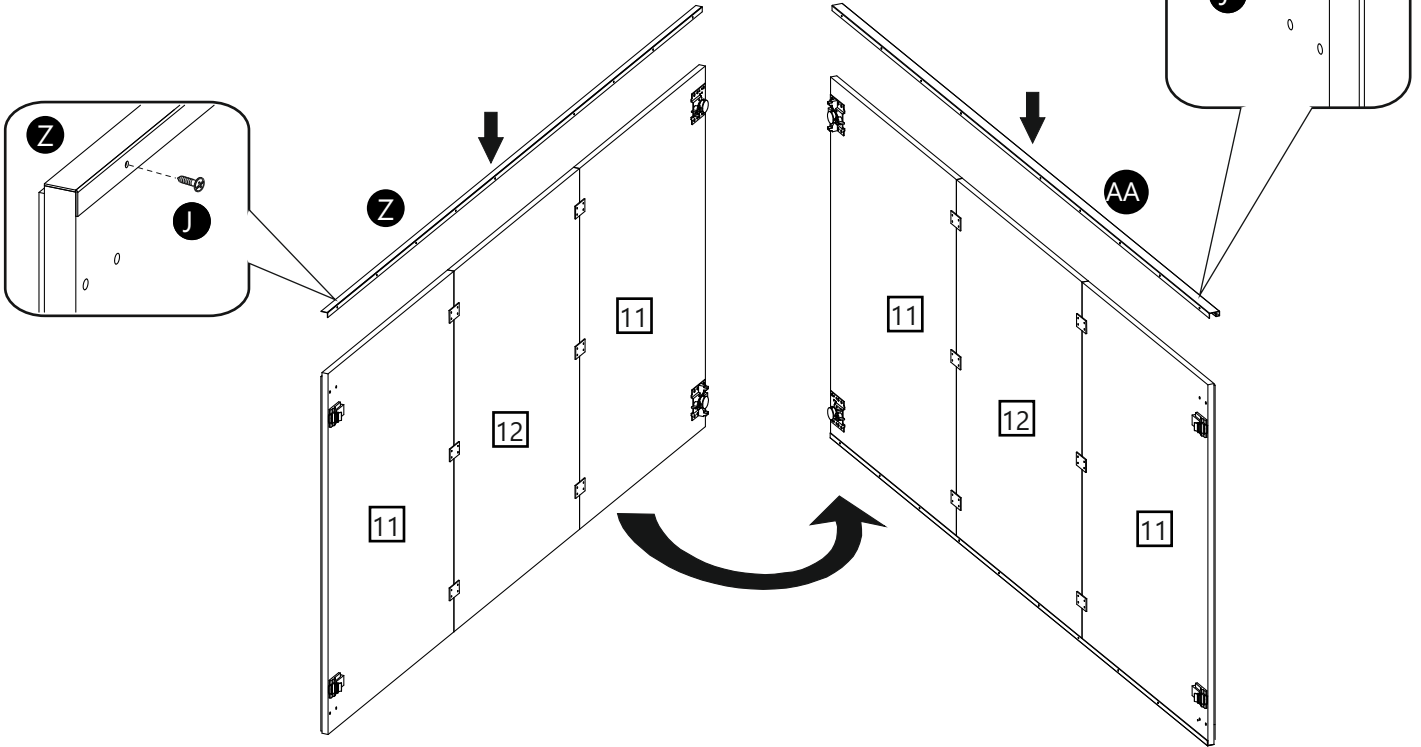

5

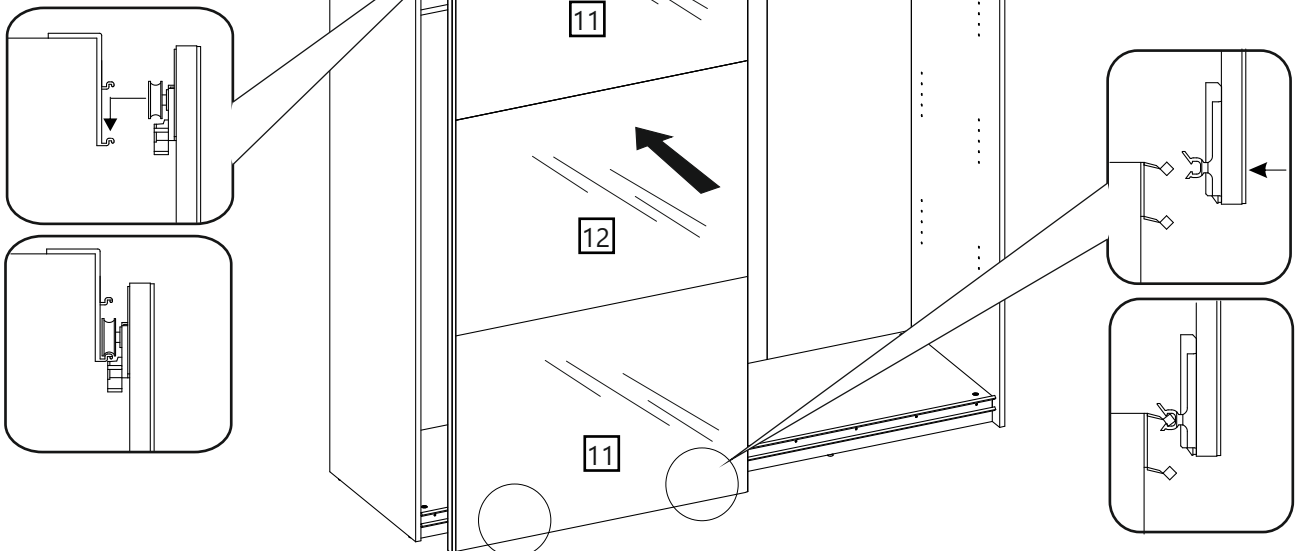
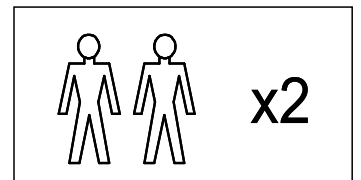

6

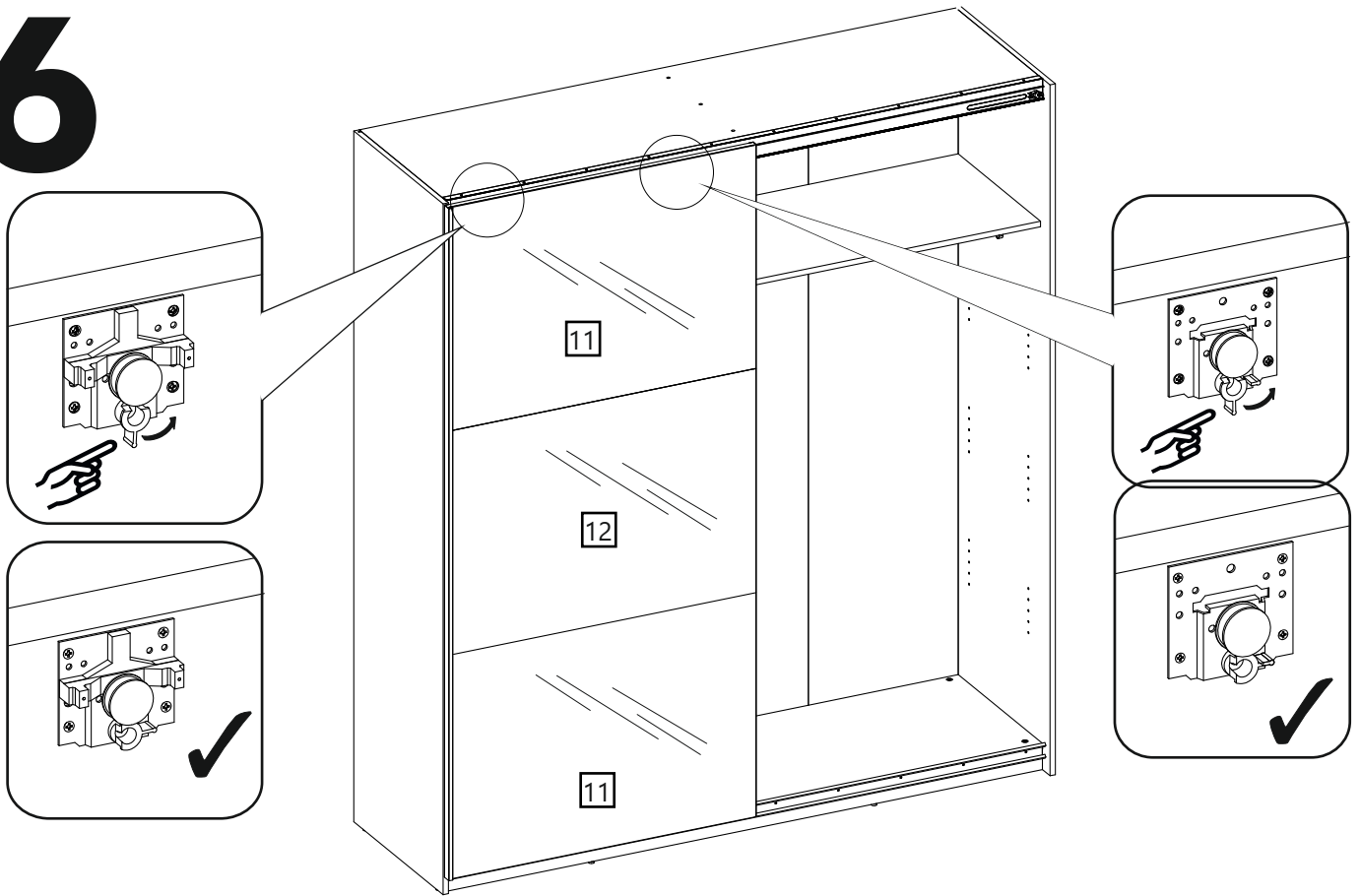

7

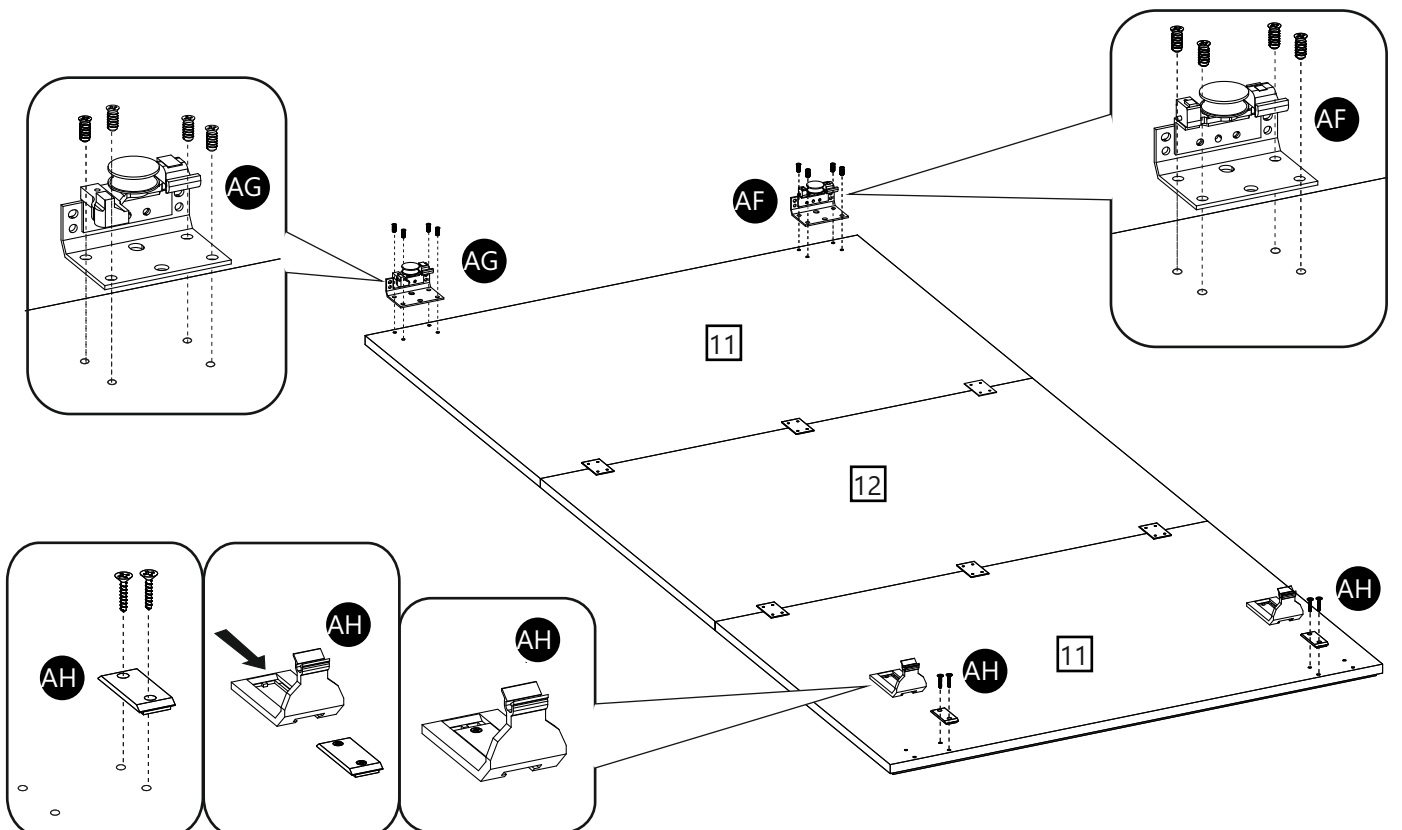
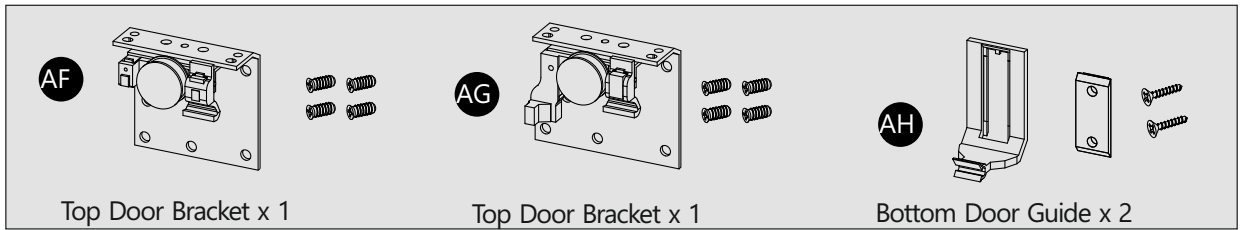

8

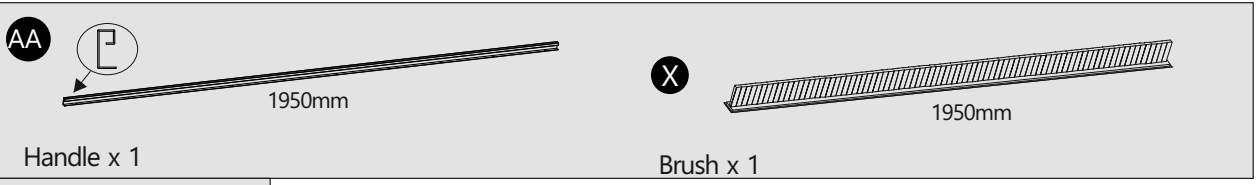

Please, remove protective cover before fitting.

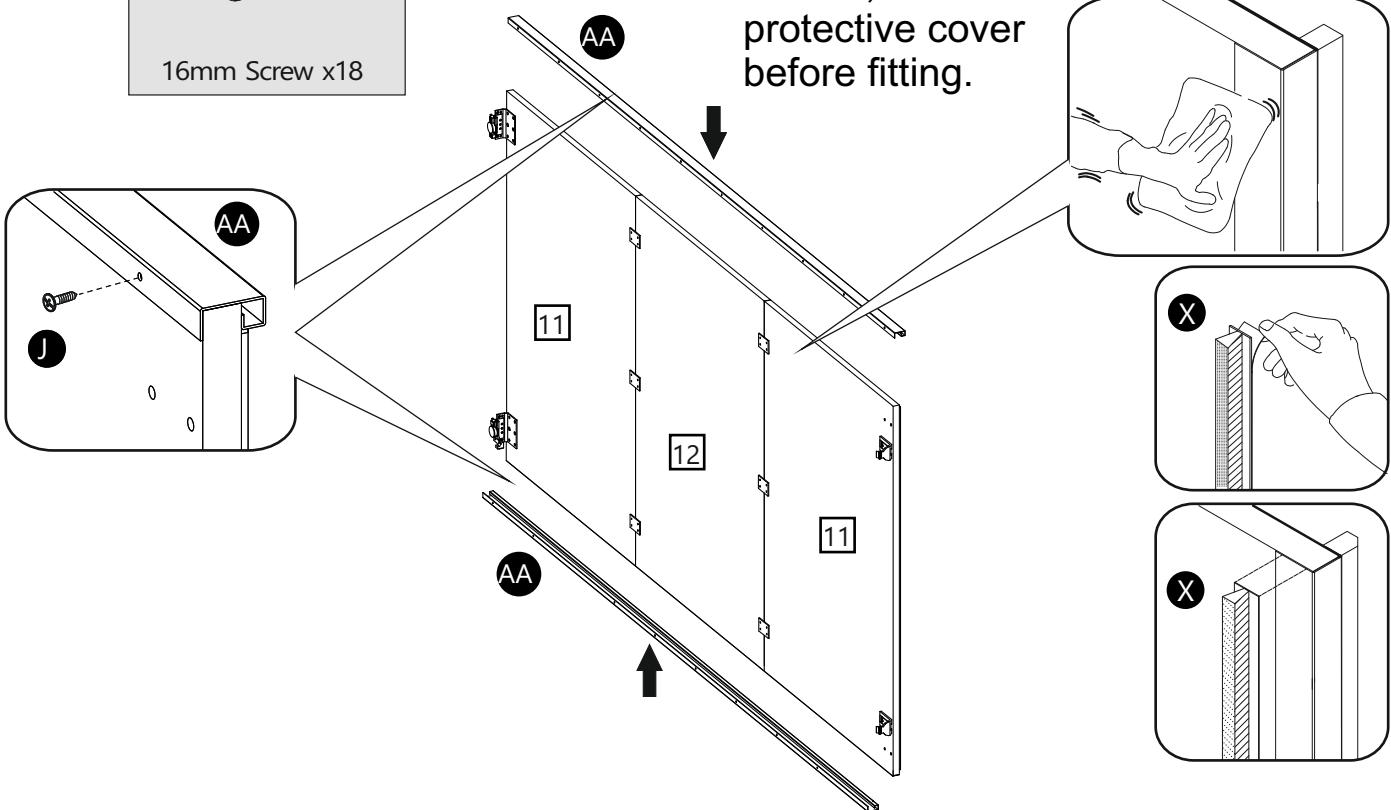

9

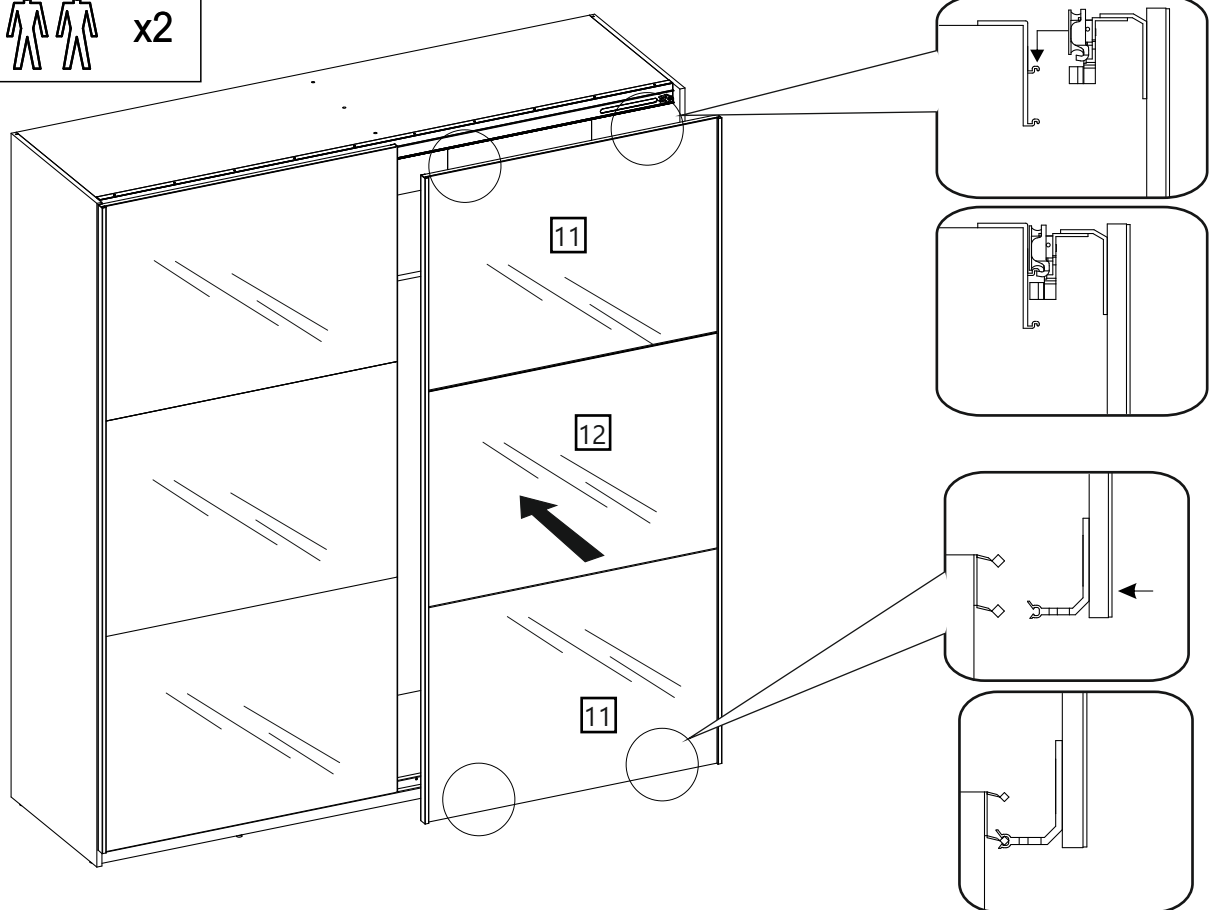
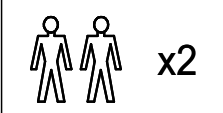

**Mirror Door
With Diamond Strip
Pages 38>42**

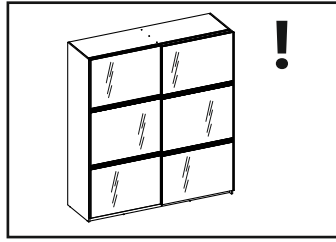

1

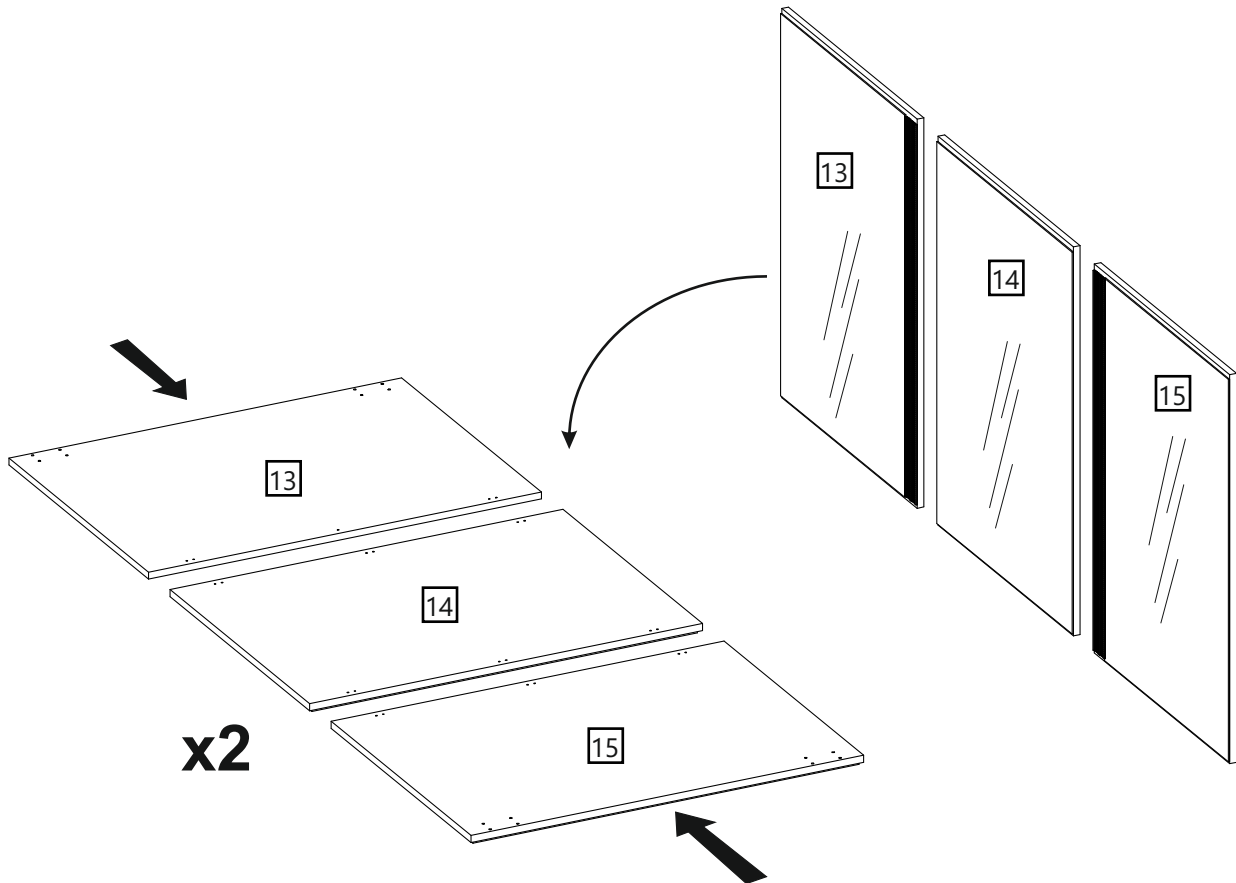

2

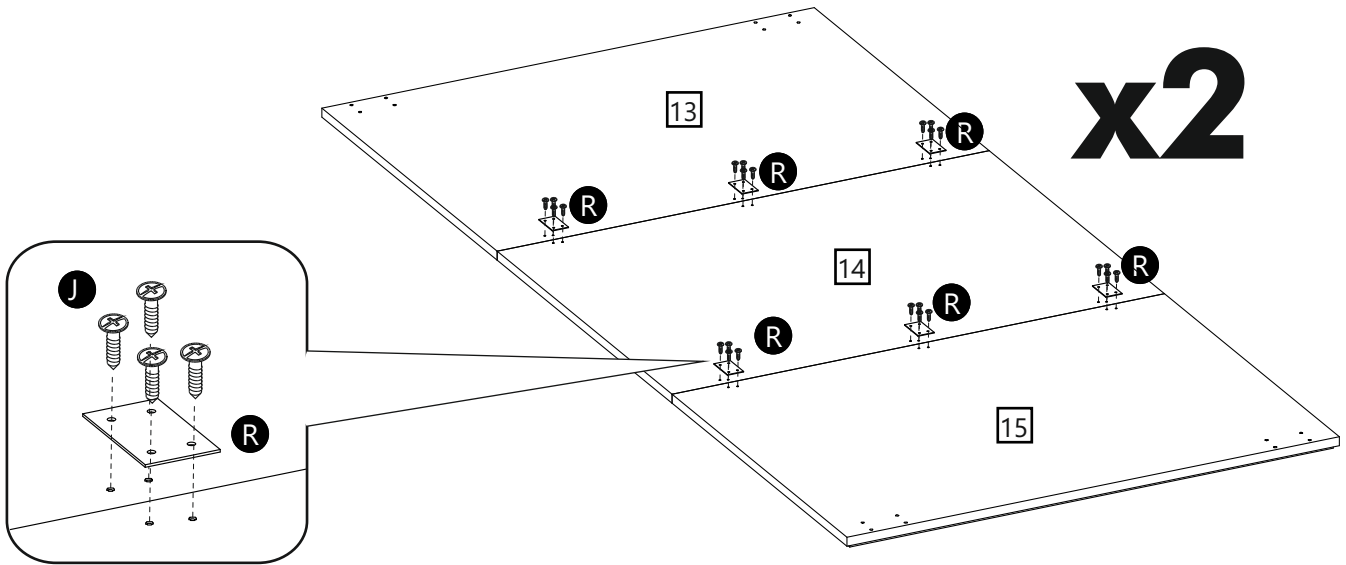
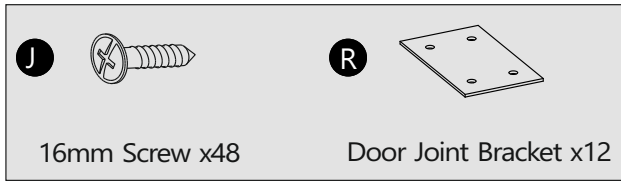

3

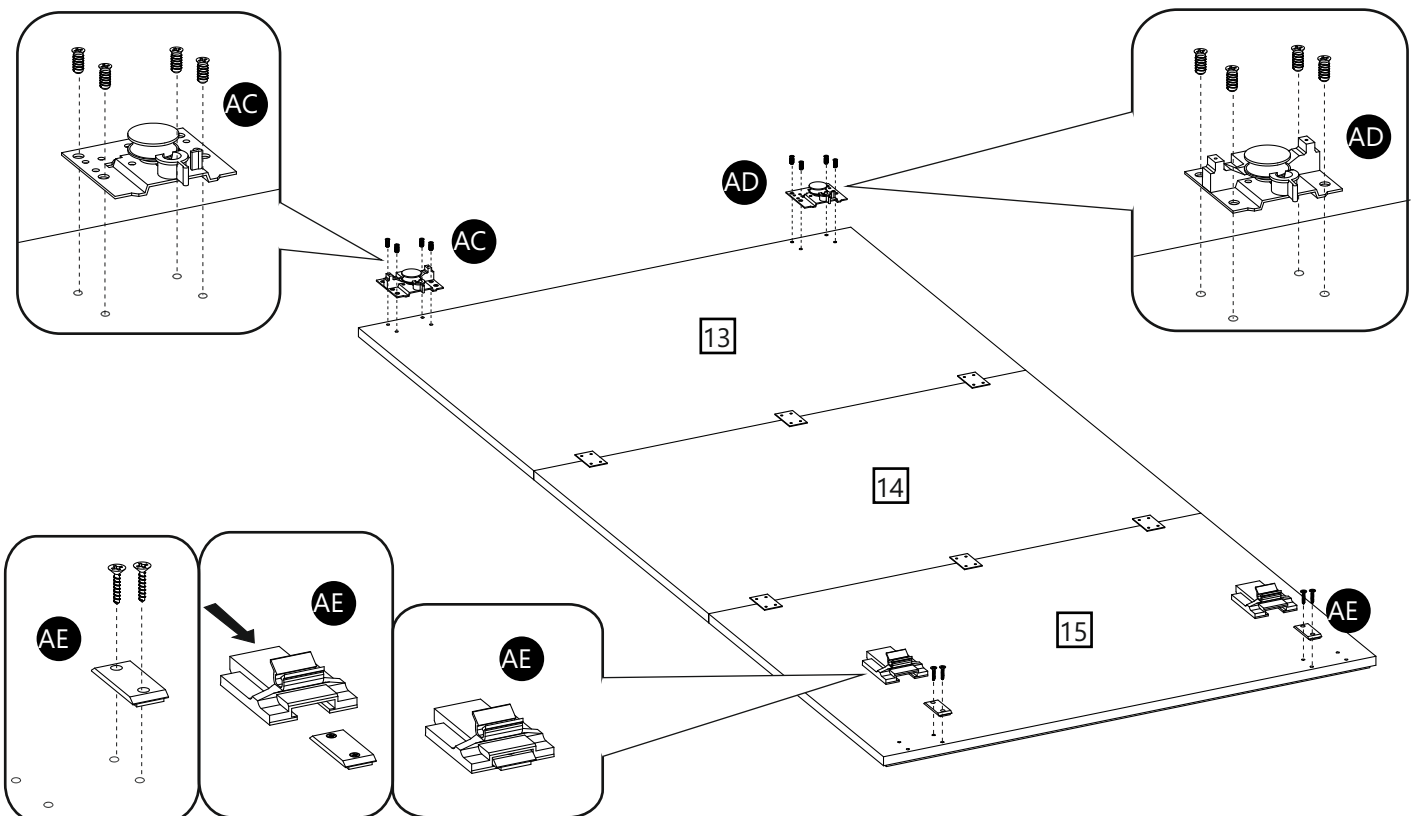
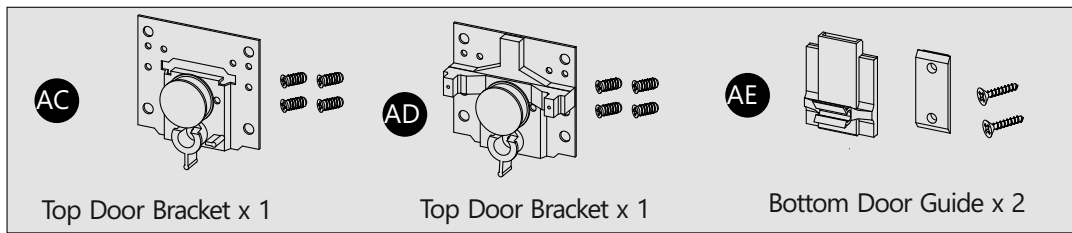

4

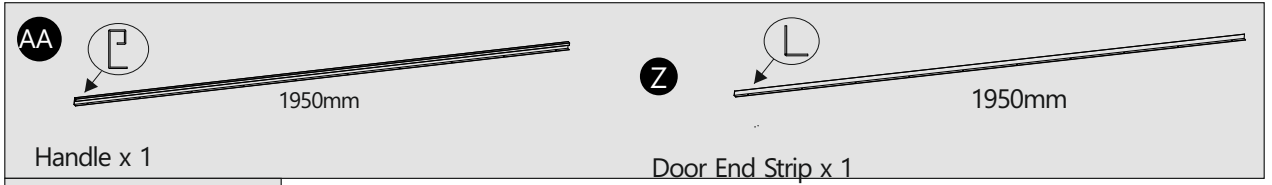

Please, remove protective cover before fitting.

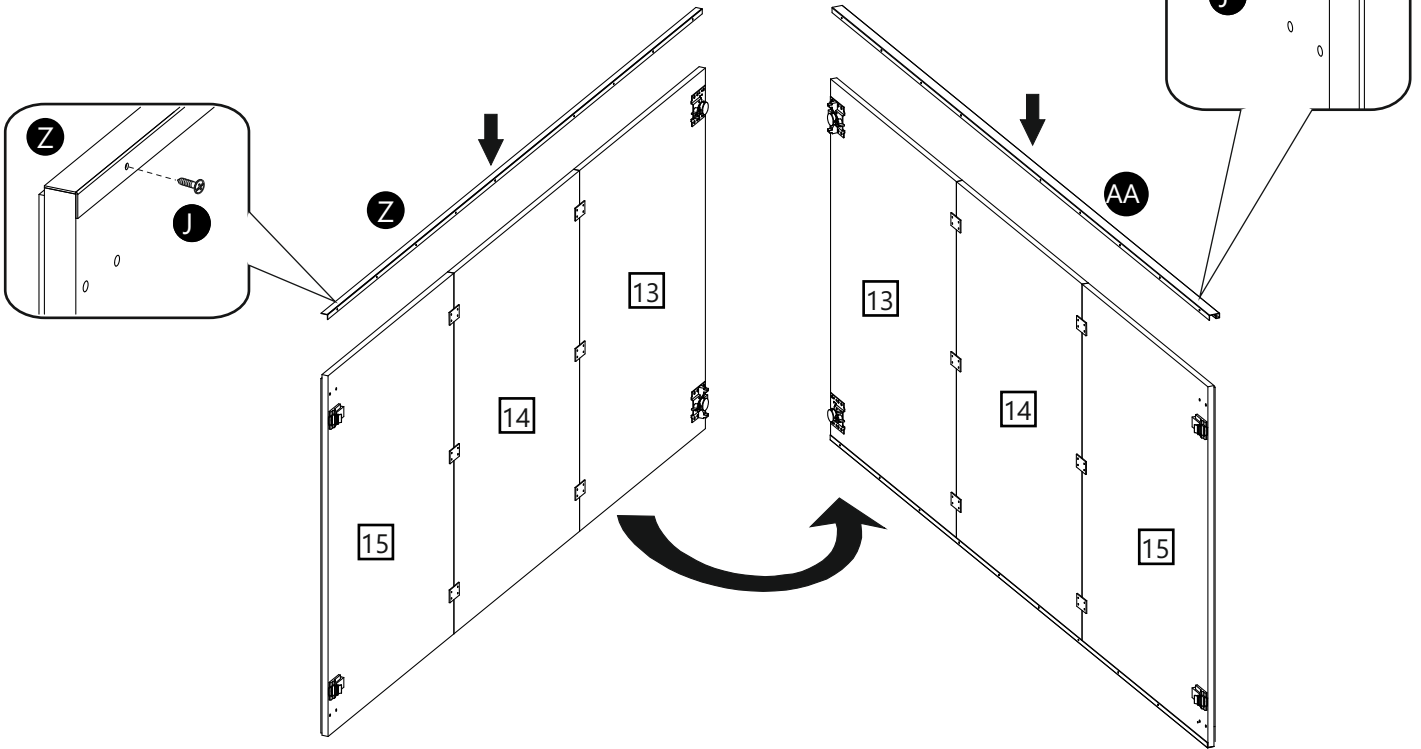

5

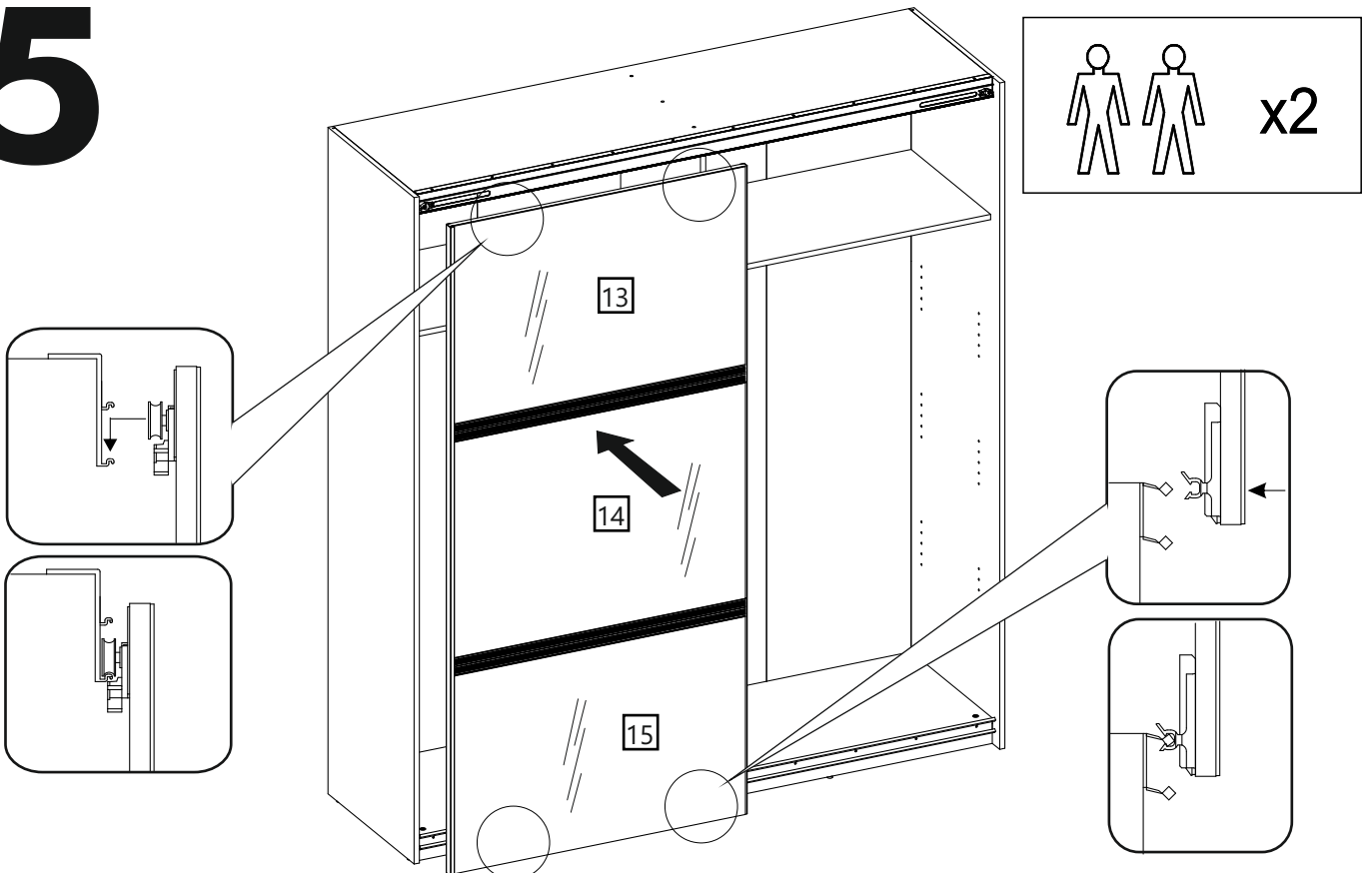

6

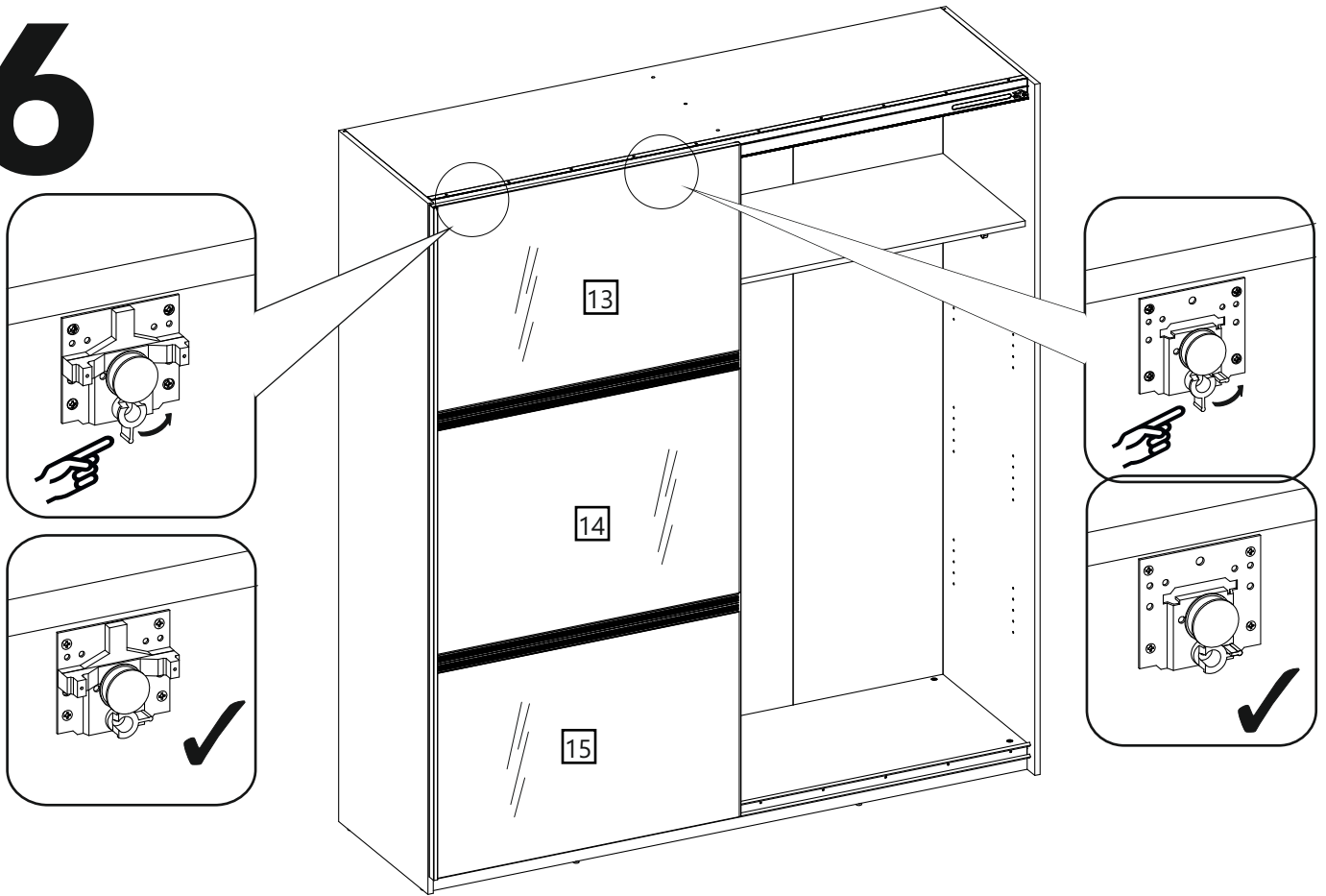

7

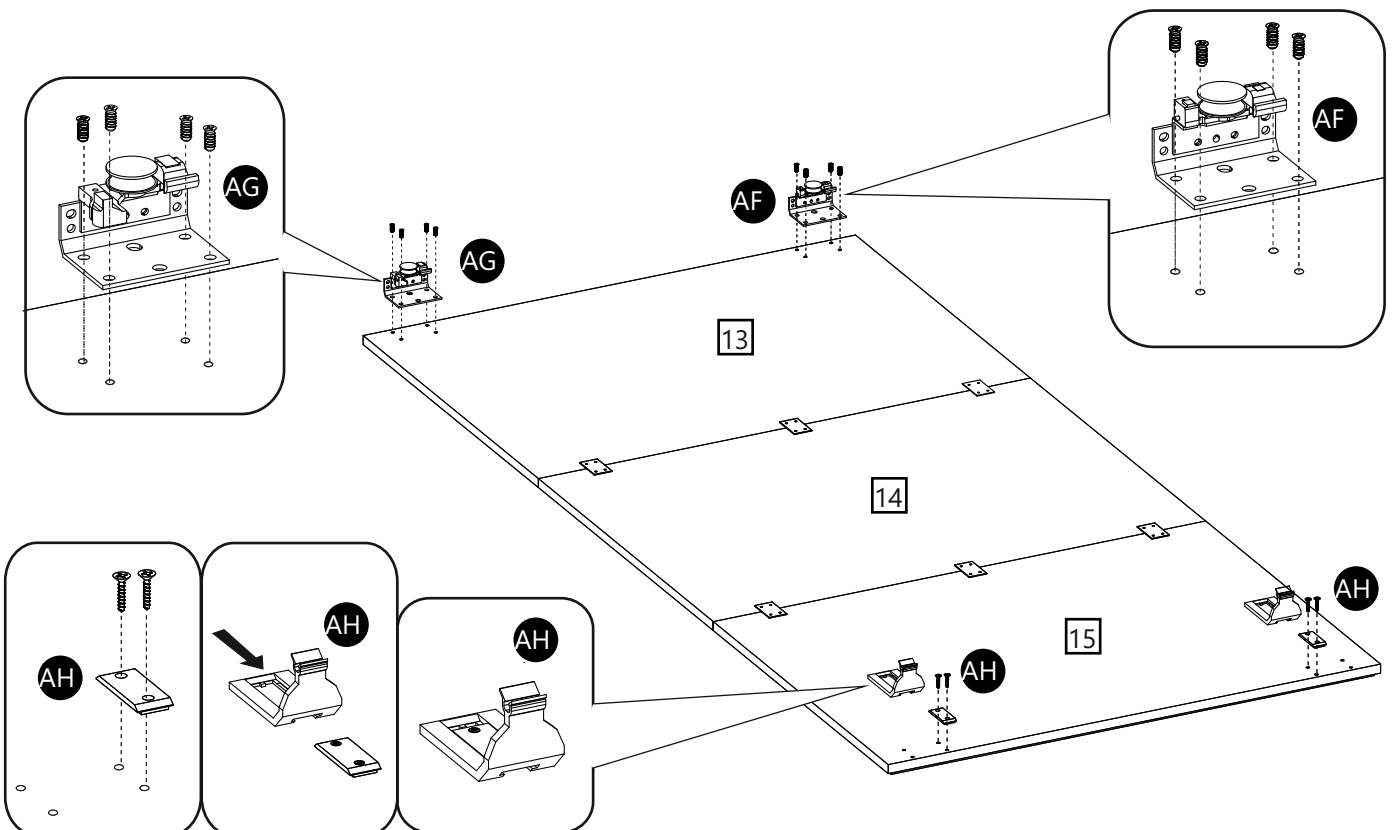
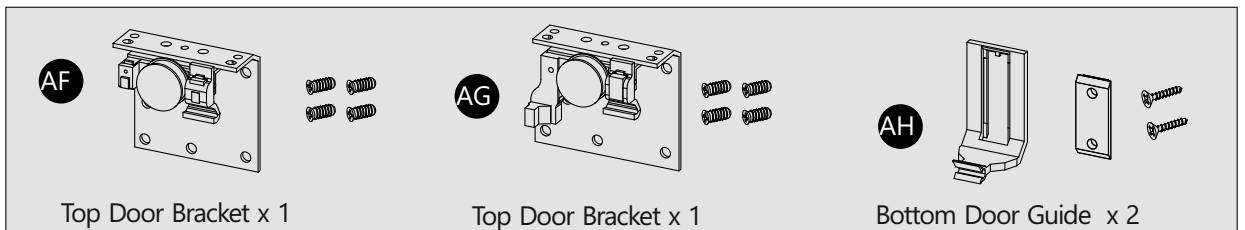

8

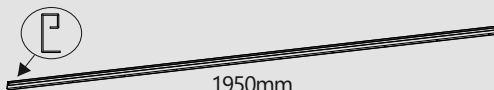
AA  1950mm
Handle x 1

X  1950mm
Brush x 1

J 
16mm Screw x18

Please, remove protective cover before fitting.

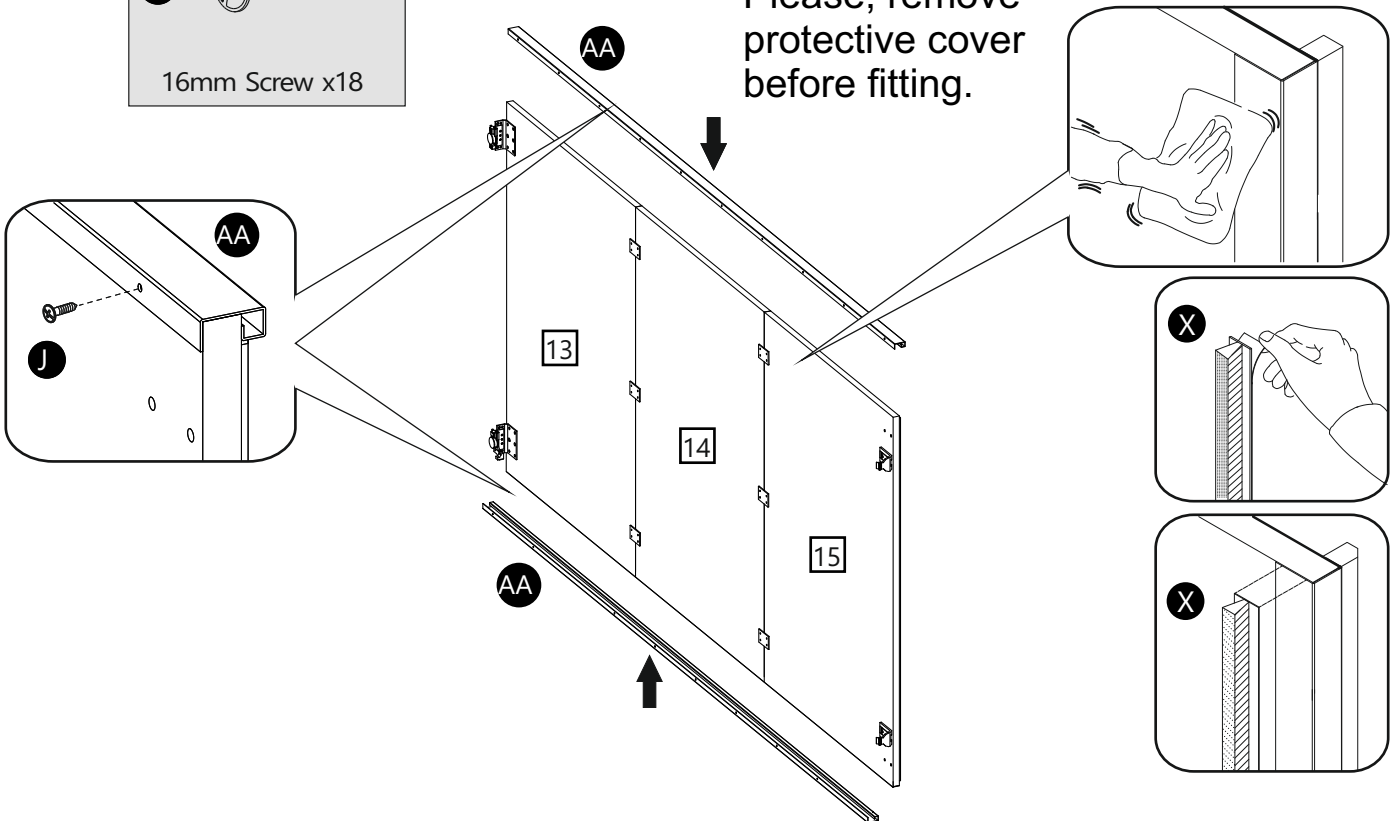

9

 x2

