

CARE OF YOUR 3 SEATER SOFA BED

Do not discard any of the packaging until you have checked the product.

Outlined below are General Care Instructions that will help prolong the look and life of your sofa bed by preventing wear and damage.

PLEASE NOTE: The Fabric on this product is Flame Retardant treated and therefore should be Specialist Upholstery cleaned only

CLEAN REGULARLY:

- ✚ Remove dust by pre-brushing with a soft brush
- ✚ Gently Vacuum all areas

SUNLIGHT AND HEAT

- ✚ Direct sunlight or heat can cause fabrics to deteriorate or fade. Protect them by situating your furniture out of the way of prolonged direct sunlight or by drawing curtains and blinds when applicable.
- ✚ Avoid placing furniture too close to fires or radiators.
- ✚ Reduce potential damage by moving items around or changing position so that the same piece or area is not always exposed.

SAFETY WARNINGS

✚ **ENTRAPMENT WARNING: KEEP HANDS CLEAR WHEN ADJUSTING THE RATCHET MECHANISM TO AVOID FINGER ENTRAPMENT: DO NOT ALLOW CHILDREN TO ADJUST THE MECHANISM.**

- ✚ Never allow children to jump on the Sofa bed.
- ✚ Do not allow domestic pets to climb on the sofa bed or chew or claw it; oils and greases from animals will cause deterioration in the appearance of the fabric.
- ✚ Sharp objects such as buckles, toys and jewellery can easily snag on the fabric and produce tears and pulls in the fabric.
- ✚ Hot objects such as the heat from cups and mugs can permanently disfigure upholstery.

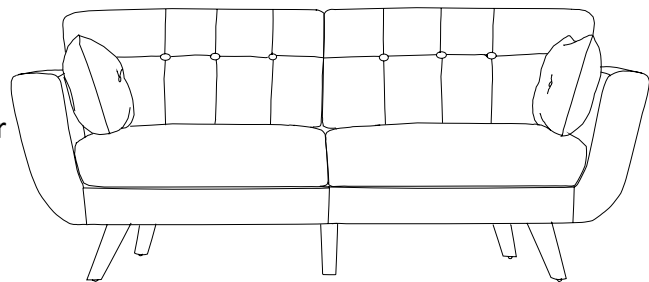

INSTRUCTIONS FOR FIXING LEGS TO 3 SEATER SOFA BED

Parts List:











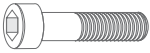
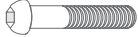

2 Person Assembly

**"PLEASE NOTE THE LEGS AND ARMS ARE PACKAGED
IN A POCKET IN THE BASE OF SOFA"**

Part list A: Armrest

Part list B: Leg

A		Armrest x 2	F		Leg x 4
B		M8 screw x 12	G		M6 screw x 16
C		Spring washer x 12	H		Washer x 16
D		Washer x 12	I		M6 Wrench x 1
E		M8 Wrench x 1	J		Support leg x 1
			K		Plastic Washer x 1
					Hidden leg x 4 Two on each side

1) Unpack Sofa bed and check the above items are present.

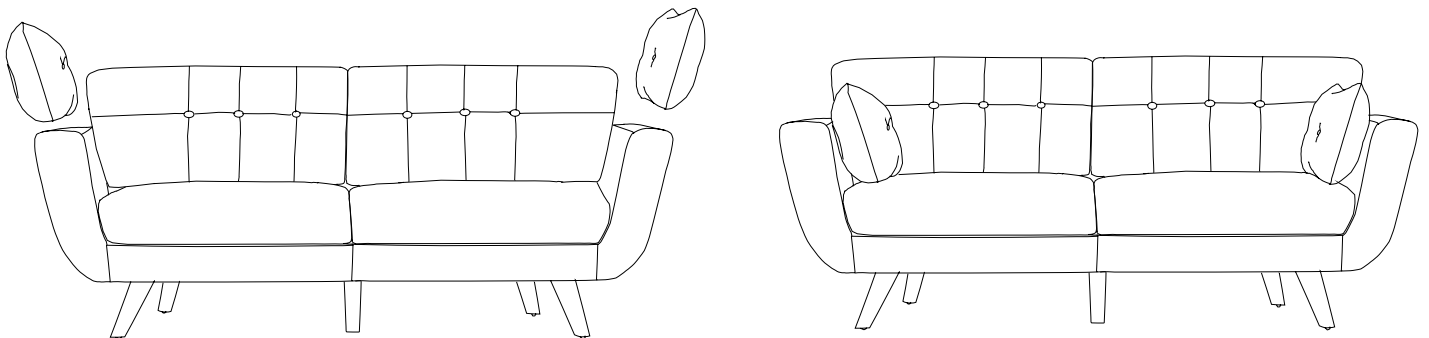
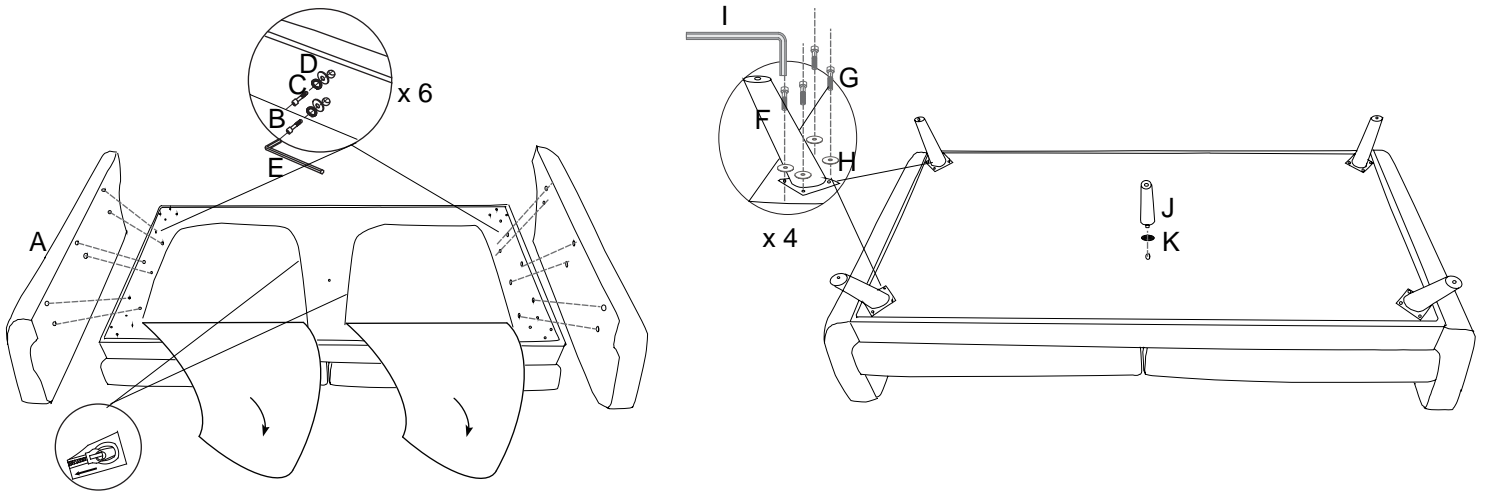

2) Place the sofa bed face down on a clean, flat surface.

3) Affix the legs as shown in the above diagram using the bolts and washers supplied. Turn the sofa bed over and place on the legs.

Sofa bed “Hidden” Legs

Please note there are four “hidden” legs in the backrest to be used when in the bed position:

- 1) Draw the legs from the backrest before converting from a sofa to the bed position.

Follow the instructions below to convert the sofa to the bed position.

- 2) To retract the legs: first convert from the bed position to the sofa (following the instructions below).

Retract the legs by pressing firmly on the button at the top of the leg (this will release the lock) and press toward the bed; zip close once retracted.

WARNING: TAKE CARE NOT TO TRAP YOUR FINGER WHEN CARRYING OUT THE ABOVE. DO NOT ALLOW CHILDREN TO PLAY WITH OR RETRACT THE LEGS.

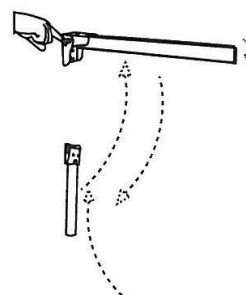

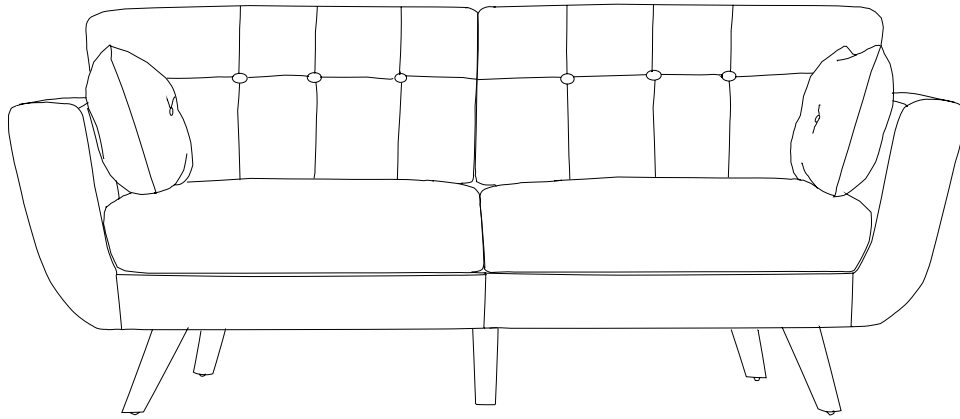

FROM SOFA TO BED: Hold the back of the sofa and tilt forward towards seat until click is heard; now tilt back into the bed position

FROM BED TO SOFA: Lift the back until 1*click is heard for recliner position;2*clicks for upright sofa position

FABRIC CONTENT:
MAIN FABRIC 100% POLYESTER
OTHER FABRIC (VISIBLE):
NON-WOVEN FABRIC 100% POLYESTER