







ASSEMBLY INSTRUCTION

SLIM BOOKCASE _ KD

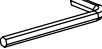
No	LIST OF HARDWARE	FIG	Q.ty (pcs)
①	Bolts M6x35		20
②	Spring Washers		20
③	Flats Washers		20
④	Allen key K4		1
⑤	Round head Screws Ø3.5x15		21
⑥	Screws Ø4x20		2
⑦	Brackets		2
⑧	Ties		1

Screwdriver (not included) 

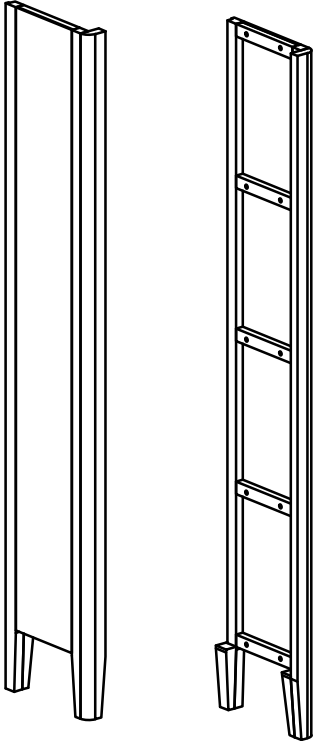
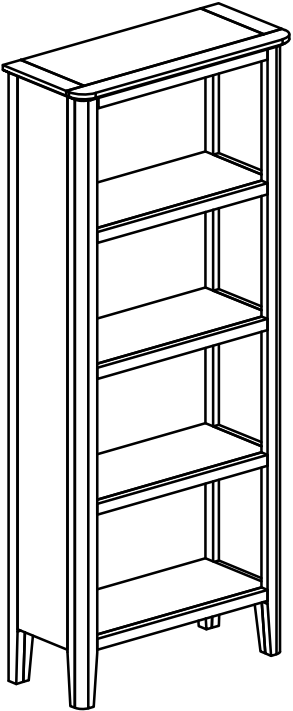

(A) Side frame (Left - Right): x 2

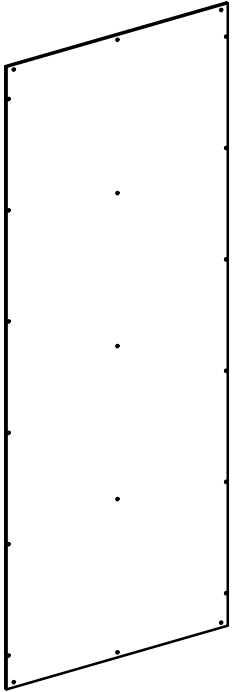

(B) Back panel: x 1

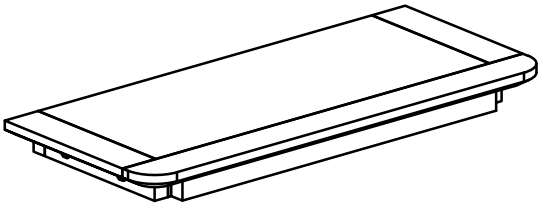

(C) Top Frame: x 1

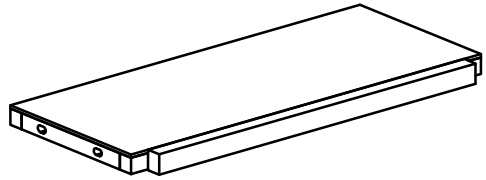

(D) Shelves: x 4

ASSEMBLY INSTRUCTION SLIM BOOKCASE _ KD

STEP 1

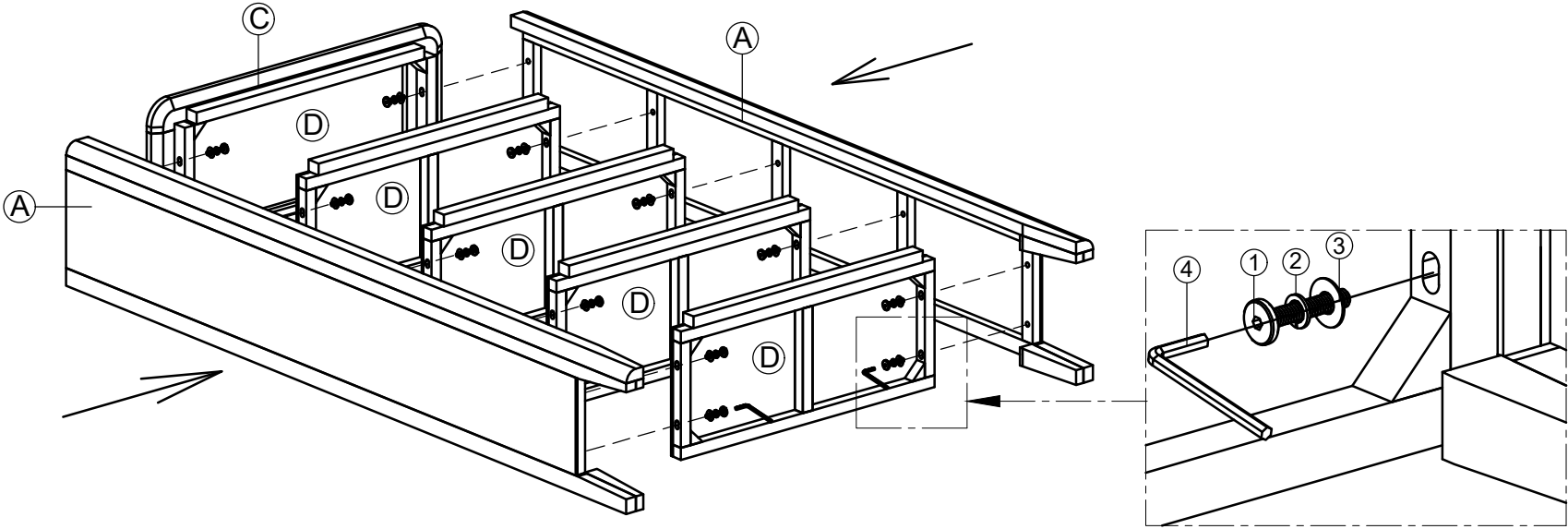

STEP 2

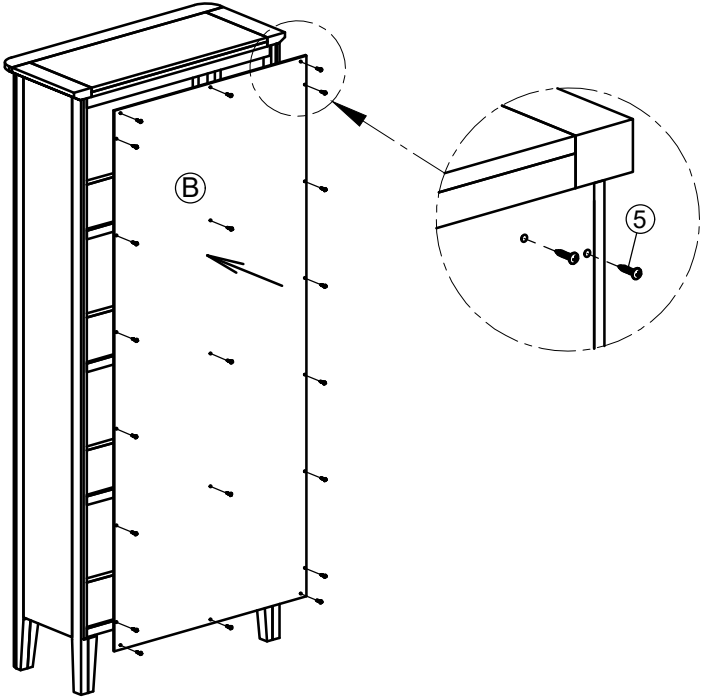

STEP 3

