

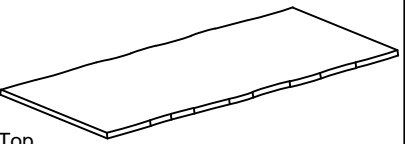

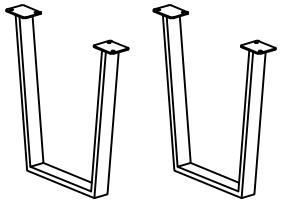

ASSEMBLY INSTRUCTION

G7502 - FIXED DINING TABLE 2000

No	Name of Component	Q.ty
Ⓐ	 Top	1
Ⓑ	 Legs	2
No	Name of Hardware	Q.ty
①	Bolt M8 x 25 	8
②	Flat Washer M8 	8
③	Spring Washer M8 	8
④	Allen key K4 	1

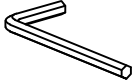