







ASSEMBLY INSTRUCTION

LOW BOOKCASE _ KD

No	LIST OF HARDWARE	FIG	Q.ty (pcs)
①	Bolts M6x30		16
②	Allen key K4		1
③	Round head Screws Ø3.5x15		20
④	Screws Ø4x20		2
⑤	Brackets		2
⑥	Tie		1
Screwdriver (not included)			

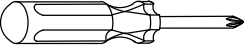
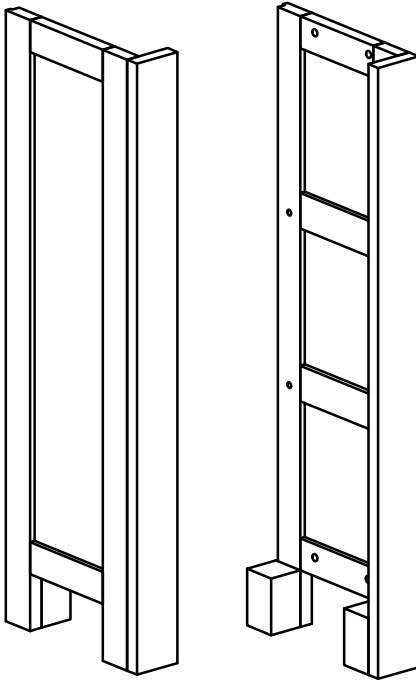

Ⓐ Side frame (Left - Right): x 2

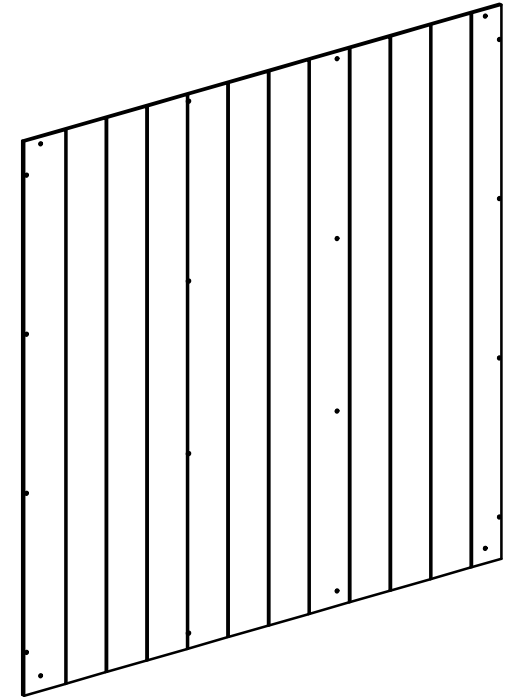

Ⓑ Back panel: x 1

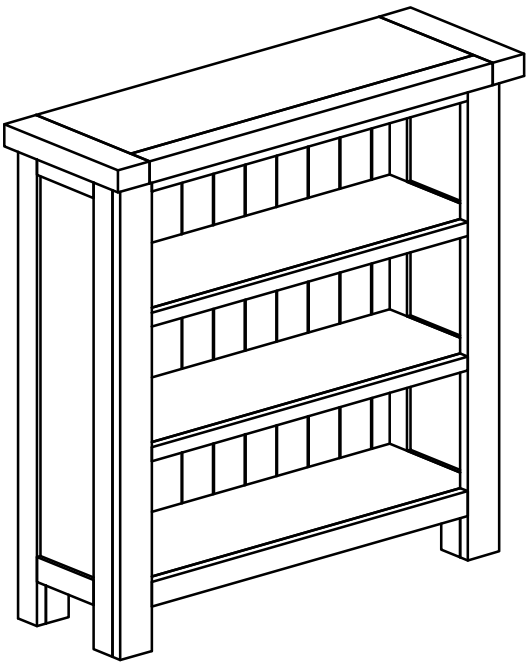

Ⓒ Top Frame: x 1

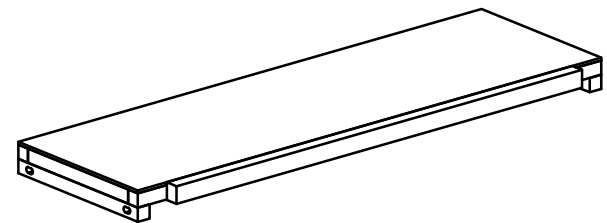

Ⓓ Shelves: x2

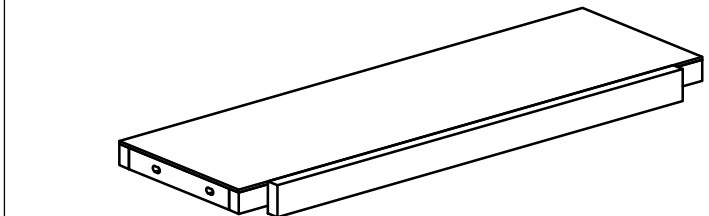
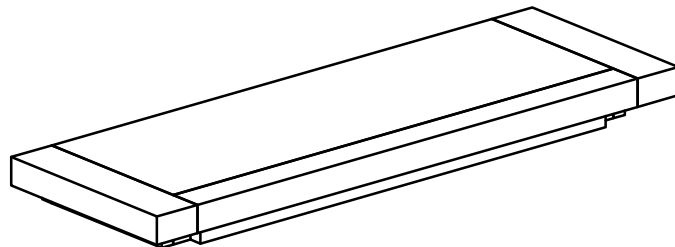

Ⓔ Bottom Frame: x 1

ASSEMBLY INSTRUCTION LOW BOOKCASE _ KD

STEP 1

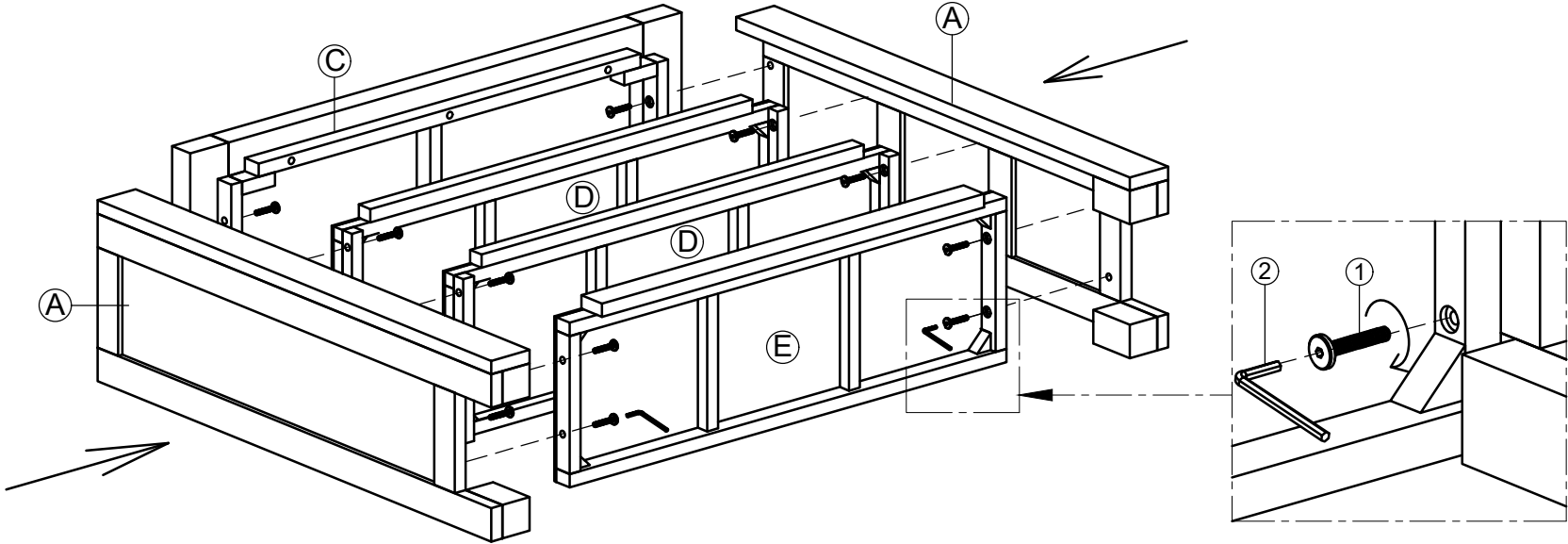

STEP 2

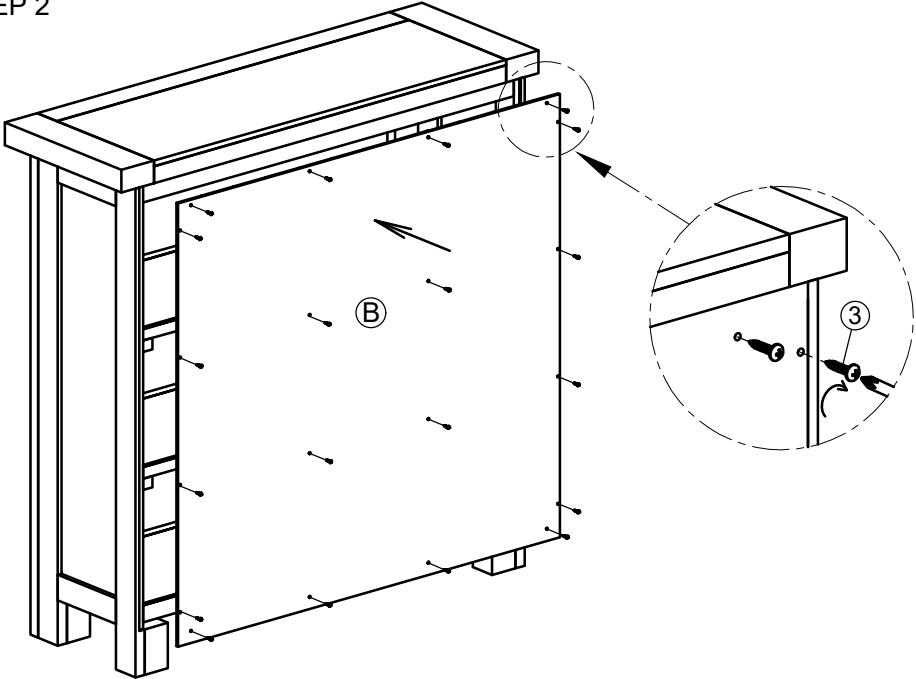

STEP 3

