









# ASSEMBLY INSTRUCTION LARGE BOOKCASE \_ KD

No	LIST OF HARDWARE	FIG	Q.ty (pcs)
①	Bolts M6x30		24
②	Flat Washers		24
③	Allen key K4		1
④	Round head Screws Ø3.5x15		30
⑤	Screws Ø4x20		2
⑥	Brackets		2
⑦	Tie		1
Screwdriver (not included)			



Ⓐ Side frame (Left - Right): x 2

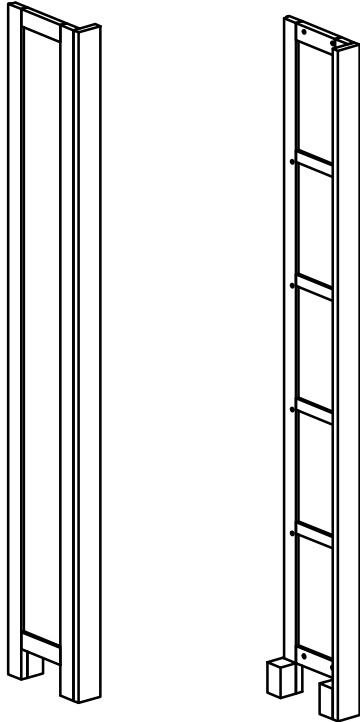
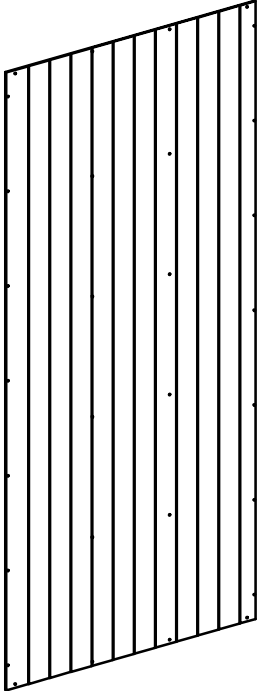

Ⓑ Back panel: x 1

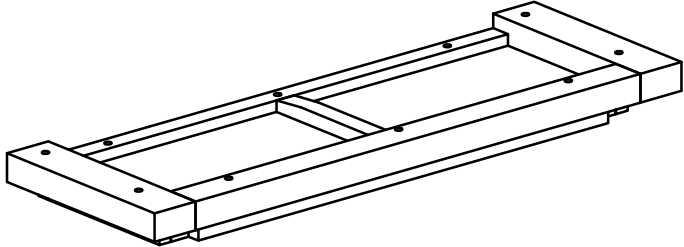
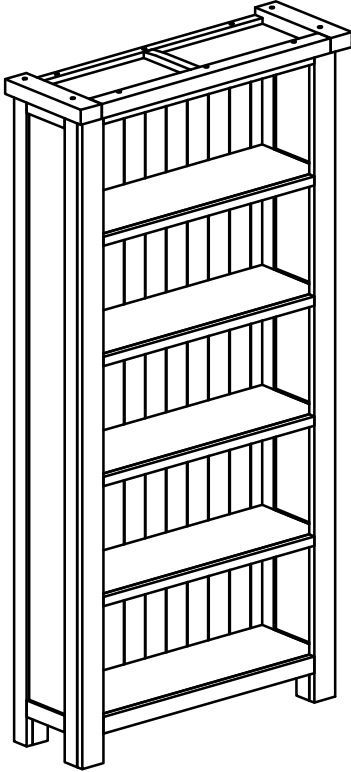

Ⓒ Top Frame: x 1

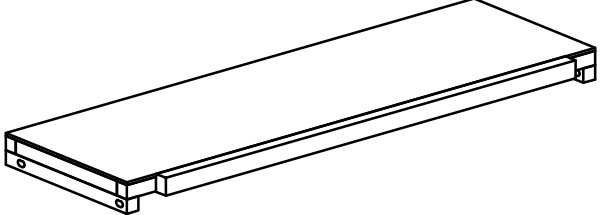

Ⓓ Shelves: x4

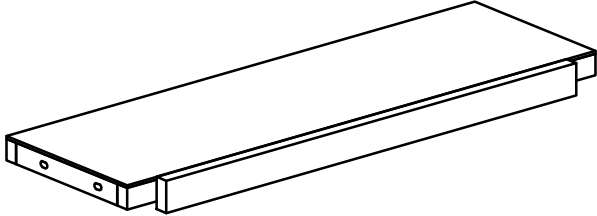

Ⓔ Bottom Frame: x 1

# ASSEMBLY INSTRUCTION LARGE BOOKCASE \_ KD

## STEP 1

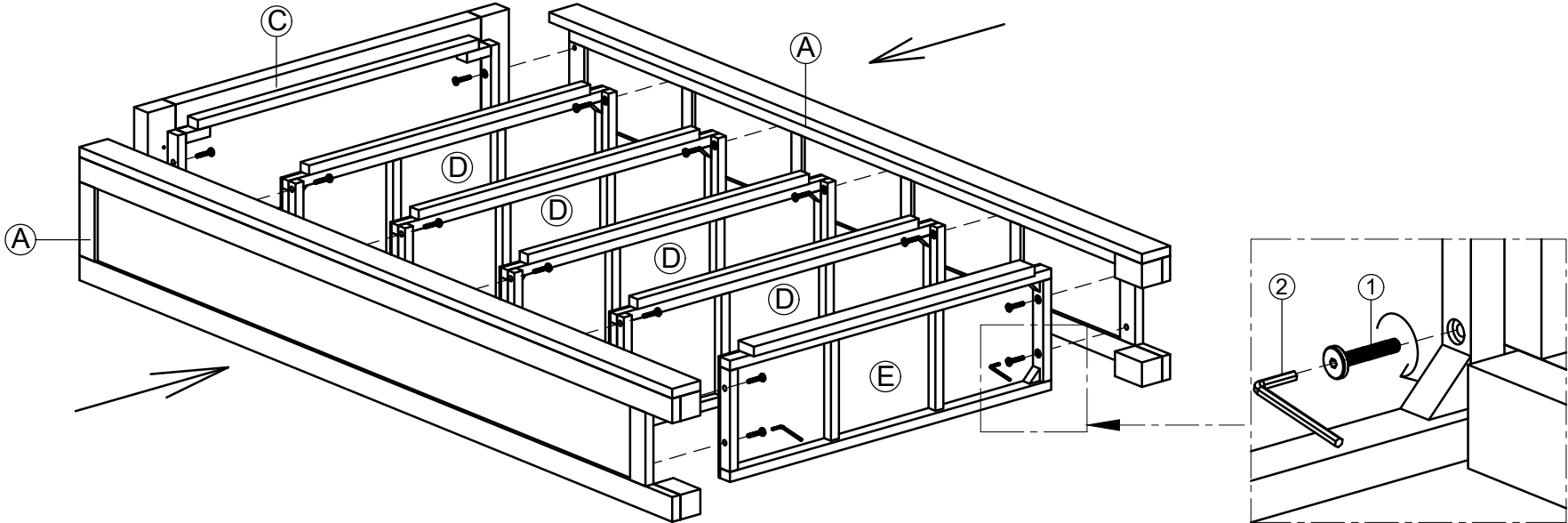

## STEP 2

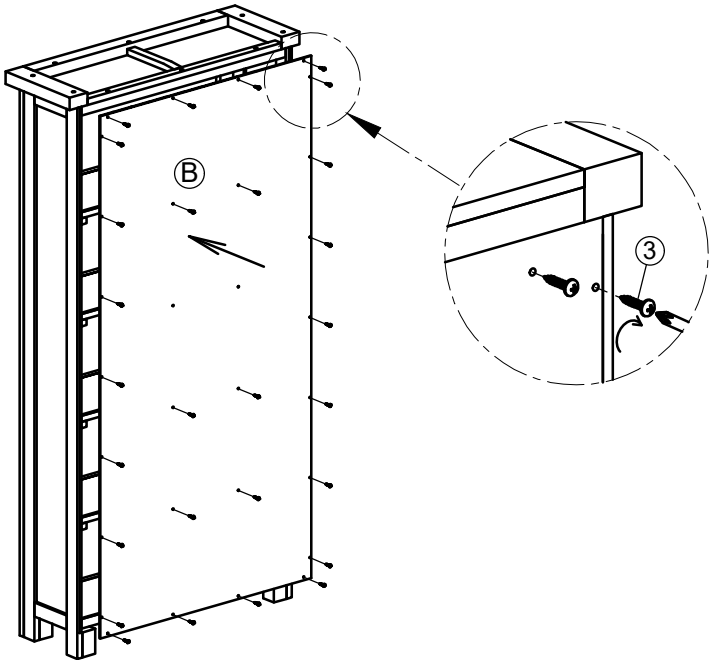

## STEP 3

