









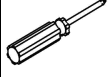

Assembly Instructions

Hand Crafted Furniture

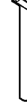
Code: MD003

Hardware list includes factory installed bolts and washers for side rails attachment.

A	B	C	D	E	F	I	J	L	O	Y	Z
											
Bolt	Bolt	Metal Plate	Screwdriver	Washer	Wooden Leg	Allen Wrench	Center Support leg	Bolt			Ø8MM
Ø7*35MM	Ø8*30MM			Ø8MM	H=13CM	Ø8MM	H=25.5CM	Ø8*50MM	Center Support	Wrench	Nut
12 PCS	20 PCS	4PCS	1PC	24 PCS	4 PCS	1 PC	2 PCS	4 PCS	1 PC	1 PC	4 PCS

Assembly Steps:

Step#1

Attach Metal plate (C) to the wooden legs (F) using Screwdriver (D), Screw (A) .Please make sure to tighten the screws.

Attach bed feet (F) to headboard and footboard .

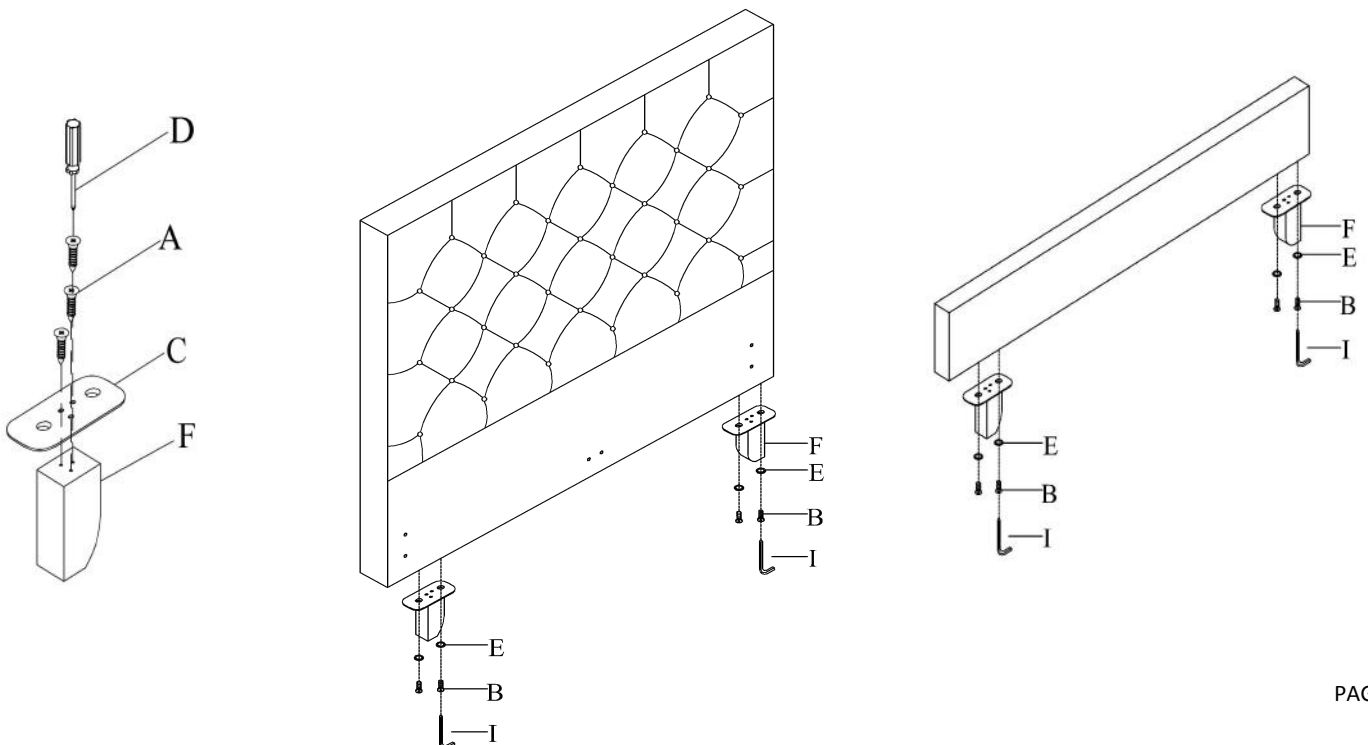

Step#2

Attach center support legs (J) to the Center Support (O) using Wrench (I), Bolt (L) and Washer (E).
Tighten/secure Nut (Z) using Wrench (Y) until snug.

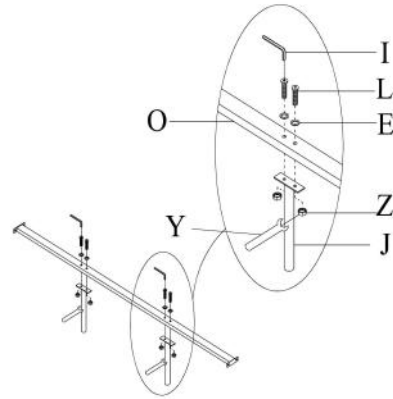

Step#3

Loosen Bolt (B) & Washer (E), attach side Rails to headboard and footboard using Wrench (I), Bolt (B) and Washer (E).

Remove Bolt (B) & Washer (E), attach steel center support (O) to the headboard and footboard using Bolt (B) and washer (E).

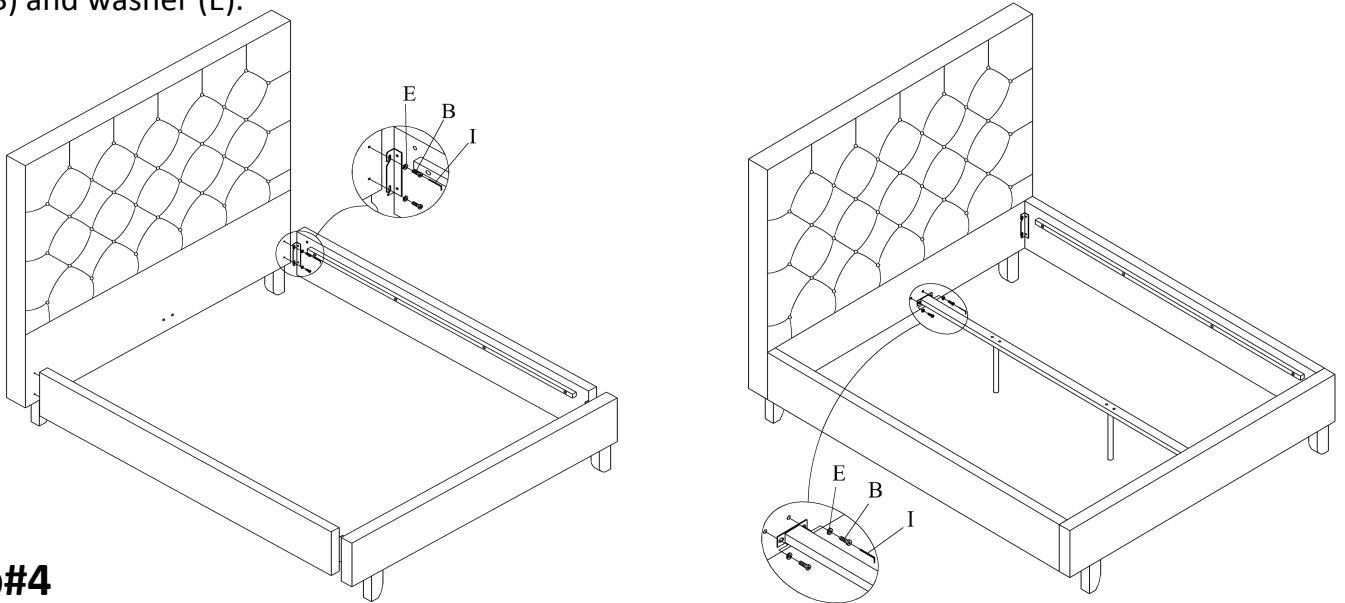

Step#4

Move/place bed into final position in bedroom.

Verify the center support legs are perpendicular to the floor for full support.

Put the base-board on the support rails.

