







# ASSEMBLY INSTRUCTION MINI BOOKCASE \_ KD

No	LIST OF HARDWARE	FIG	Q.ty (pcs)
①	Bolts M6x30		16
②	Allen key K4		1
③	Round head Screws Ø3.5x15		10
④	Screws Ø4x20		2
⑤	Brackets		2
⑥	Tie		1

Screwdriver (not included) 

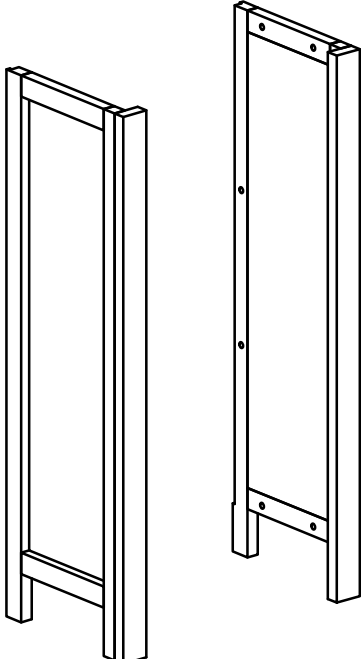
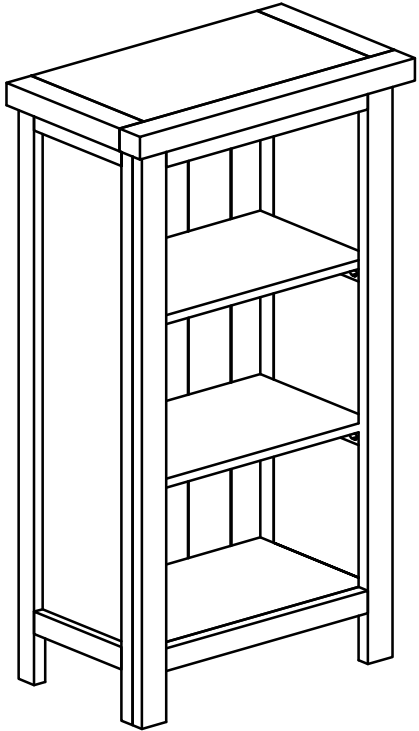

**A** Side frame (Left - Right): x 2

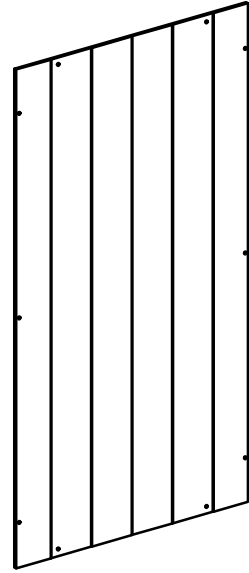

**B** Back panel: x 1

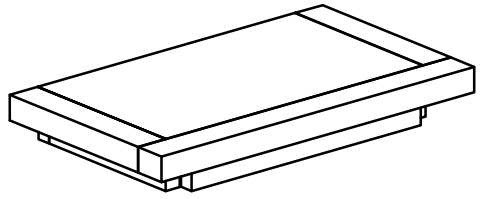

**C** Top Frame: x 1

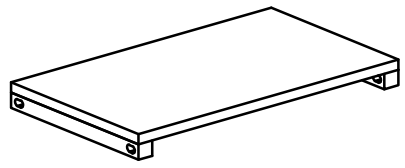

**D** Shelves: x 2

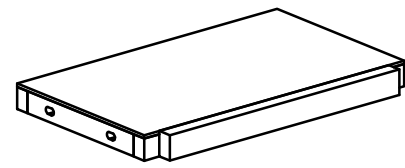

**E** Bottom Frame: x 1

# ASSEMBLY INSTRUCTION MINI BOOKCASE \_KD

## STEP 1

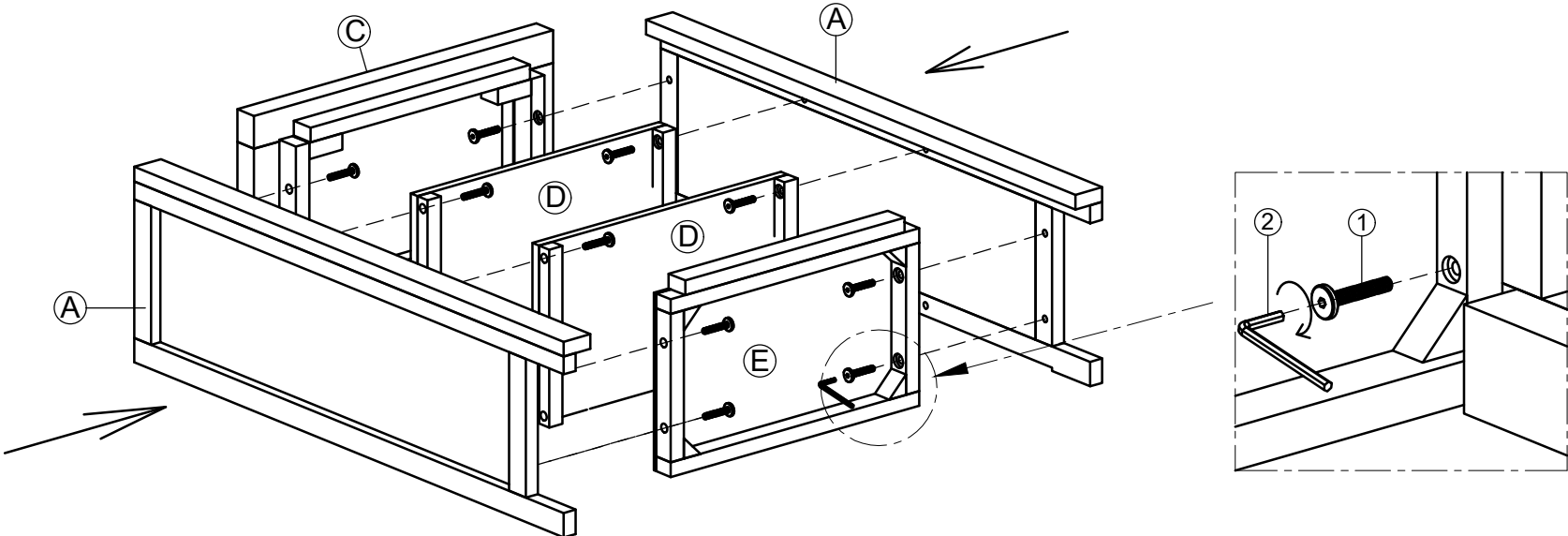

## STEP 2

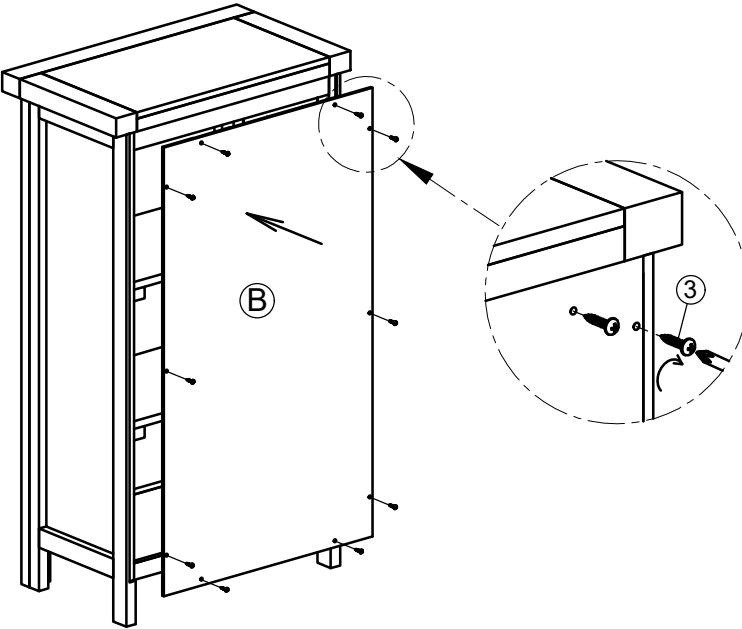

## STEP 3

