







ASSEMBLY INSTRUCTION LARGE BOOKCASE _ KD

No	LIST OF HARDWARE	FIG	Q.ty (pcs)
①	Bolts M6x35		28
②	Spring Washers		28
③	Flats Washers		28
④	Allen key K4		1
⑤	Round head Screws Ø3.5x15		32
⑥	Screws Ø4x20		2
⑦	Brackets		2
⑧	Ties		1

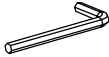
Screwdriver (not included)

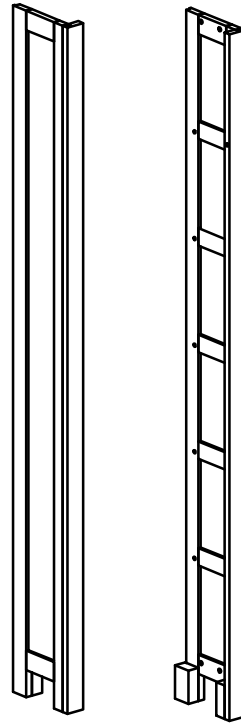
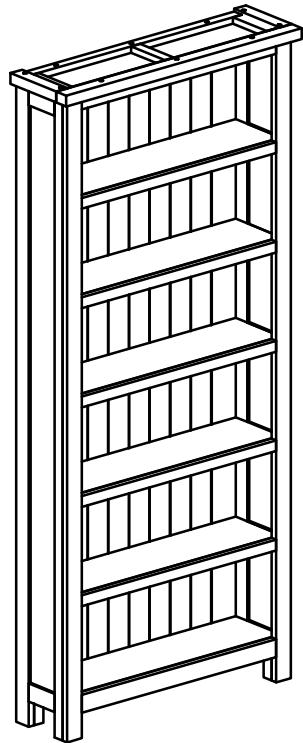
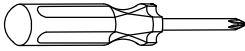

Ⓐ Side frame (Left - Right): x 2

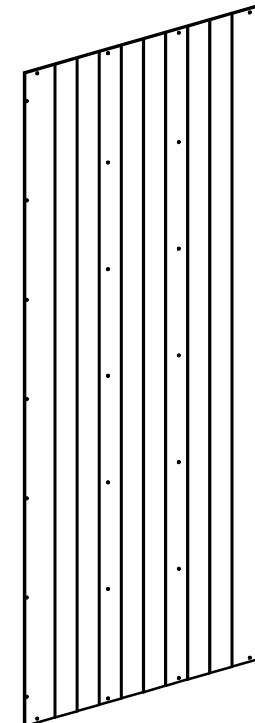

Ⓑ Back panel: x 1

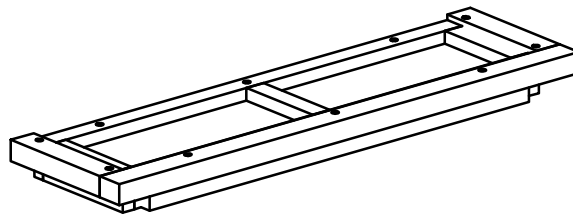

Ⓒ Top Frame: x 1

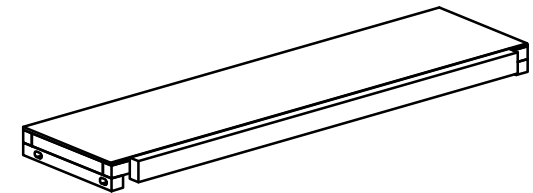

Ⓔ Shelves: x 4

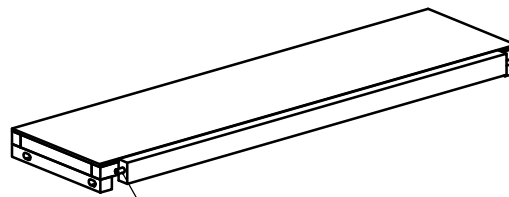

Ⓓ Top Shelf: x 1
Wooden dowels
on the front rail of top shelf

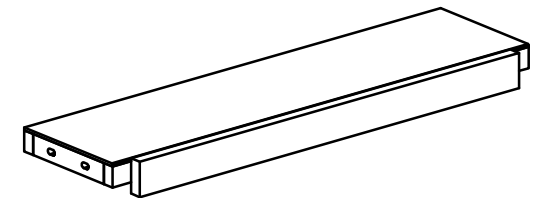

Ⓕ Bottom Frame: x 1

ASSEMBLY INSTRUCTION LARGE BOOKCASE _ KD

STEP 1

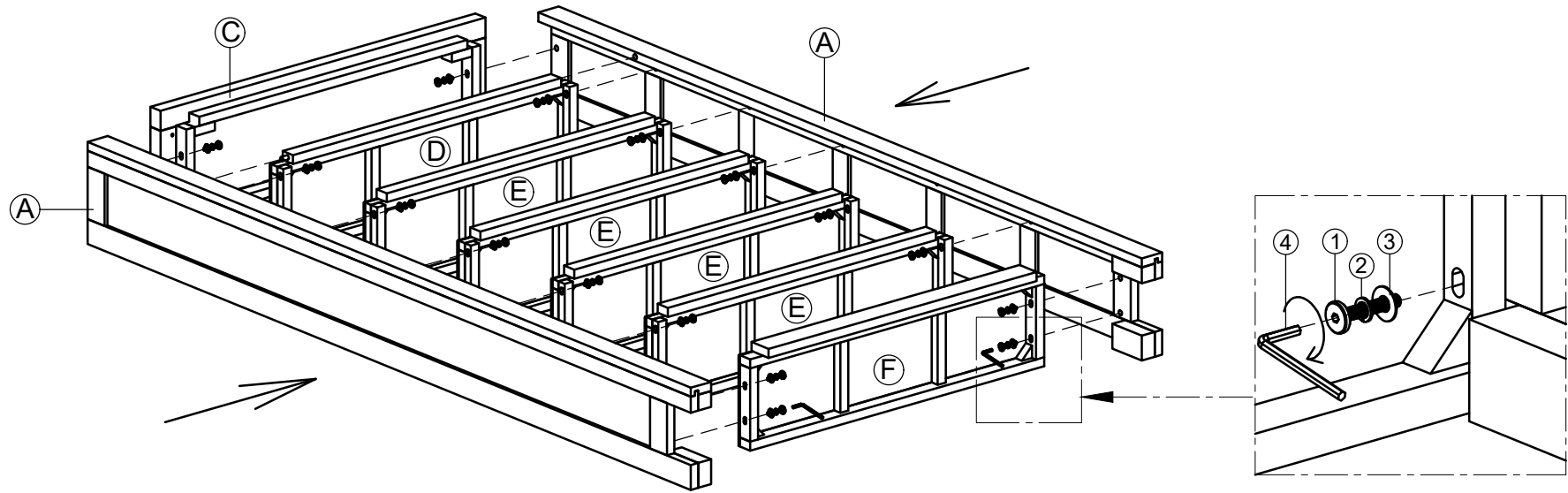

STEP 2

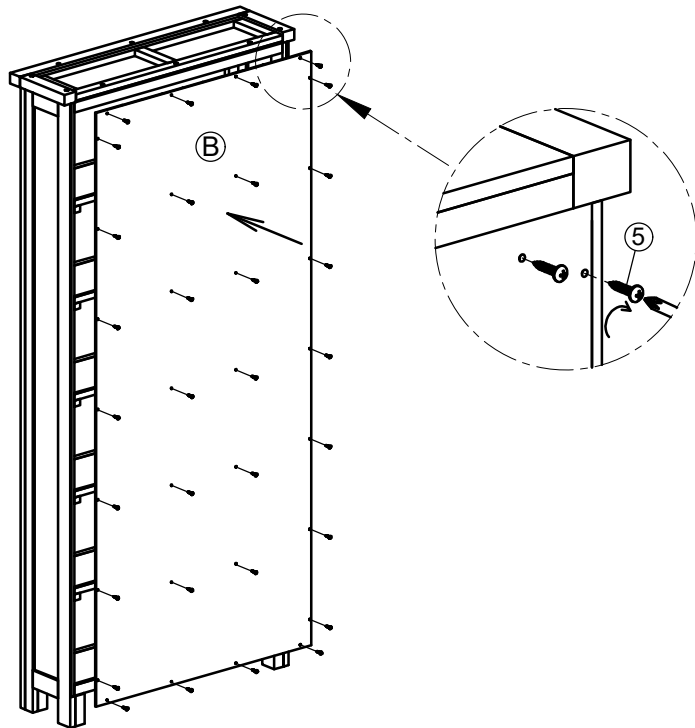

STEP 3

