



## CARE OF YOUR KY366 ACCENT CHAIR

**Do not discard any of the packaging until you have checked the product.**

Outlined below are General Care Instructions that will help prolong the look and life of your chair by preventing wear and damage.

**PLEASE NOTE: The Fabric on this product is Flame Retardant treated and therefore should be Specialist Upholstery cleaned only**

### CLEAN REGULARLY:

- ✚ Remove dust by pre-brushing with a soft brush
- ✚ Gently Vacuum all areas

### SUNLIGHT AND HEAT

- ✚ Direct sunlight or heat can cause fabrics to deteriorate or fade. Protect them by situating your furniture out of the way of prolonged direct sunlight or by drawing curtains and blinds when applicable.
- ✚ Avoid placing furniture too close to fires or radiators.
- ✚ Reduce potential damage by moving items around or changing position so that the same piece or area is not always exposed.



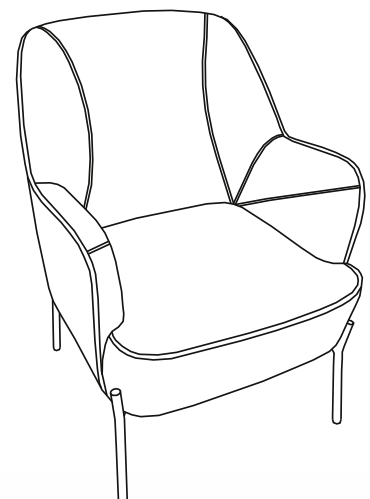

### SAFETY WARNINGS

- ✚ **ENTRAPMENT WARNING: KEEP HANDS CLEAR WHEN ADJUSTING THE RATCHET MECHANISM TO AVOID FINGER ENTRAPMENT: DO NOT ALLOW CHILDREN TO ADJUST THE MECHANISM.**
- ✚ Never allow children to jump on the chair.
- ✚ Do not allow domestic pets to climb on the chair or chew or claw it; oils and greases from animals will cause deterioration in the appearance of the fabric.
- ✚ Sharp objects such as buckles, toys and jewellery can easily snag on the fabric and produce tears and pulls in the fabric.
- ✚ Hot objects such as the heat from cups and mugs can permanently disfigure upholstery.



## INSTRUCTION FOR FIXING LEGS TO KY366 ACCENT CHAIR

### Parts List:

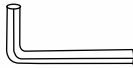
ITEM	DESCRIPTION	PIC.	QTY
A	SEAT		1
B	IRON FRAME		2
C	IRON PIPE		2
D	BOLT		4
E	BOLT		4
F	ALLEN KEY		1



2 Person Assembly

(1) Unpack chair and check the above items are present. If you have any parts missing contact Kyoto Futons Ltd (01778 ) 380555. [sales@kyoto.co.uk](mailto:sales@kyoto.co.uk)

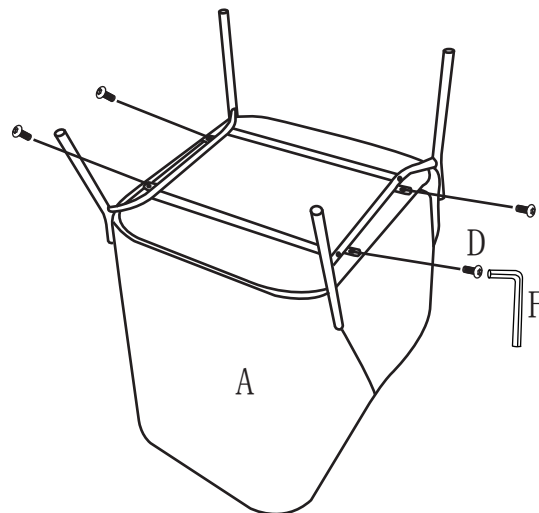
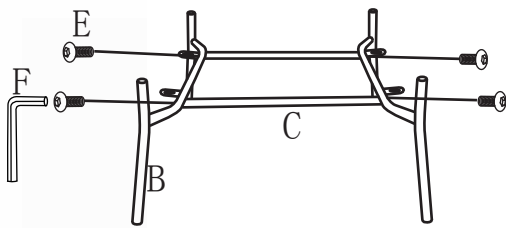

(2) Place the chair face down on a clean, flat surface.

(3) Affix the legs as shown in the above diagram using the screws and allen key supplied. Turn the chair over and place on the legs.

#### FABRIC CONTENT:

MAIN FABRIC 100% POLYESTER

OTHER FABRIC (VISIBLE):

NON-WOVEN FABRIC 100% POLYESTER