







ASSEMBLY INSTRUCTION

LARGE BOOKCASE _ KD

No	LIST OF HARDWARE	FIG	Q.ty (pcs)
①	Bolts M6x30		24
②	Allen key K4		1
③	Round head Screws Ø3.5x15		30
④	Screws Ø4x20		2
⑤	Brackets		2
⑥	Tie		1

Screwdriver (not included) 

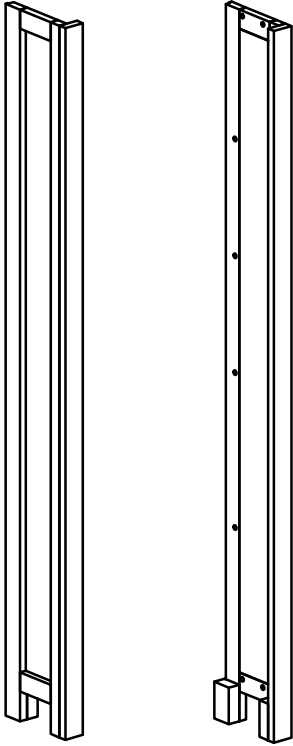
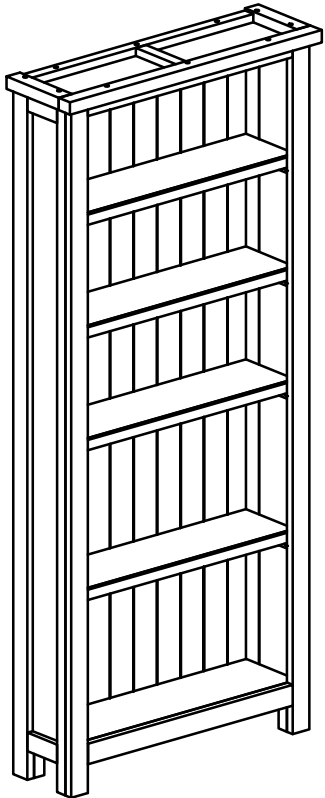

Ⓐ Side frame (Left - Right): x 2

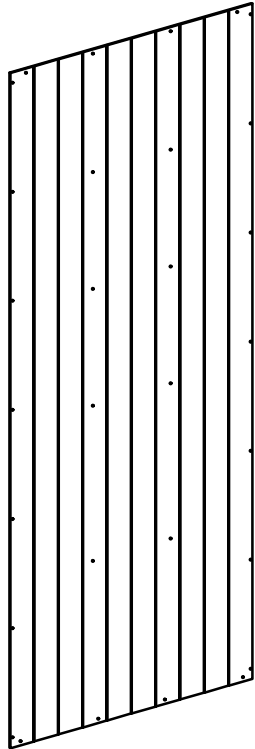

Ⓑ Back panel: x 1

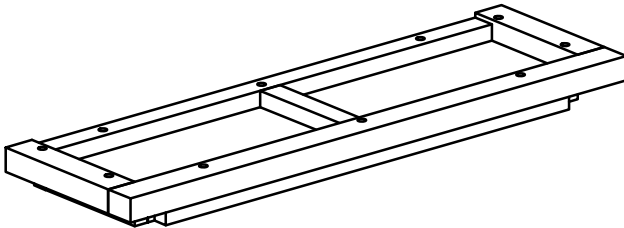

Ⓒ Top Frame: x 1

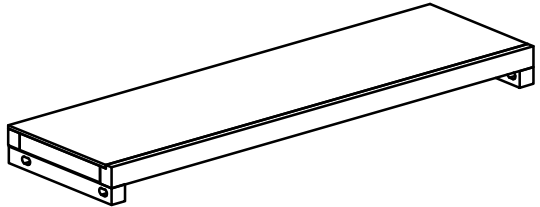

Ⓓ Shelves: x4

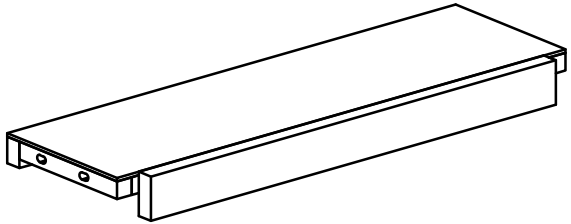

Ⓔ Bottom Frame: x 1

ASSEMBLY INSTRUCTION LARGE BOOKCASE _ KD

STEP 1

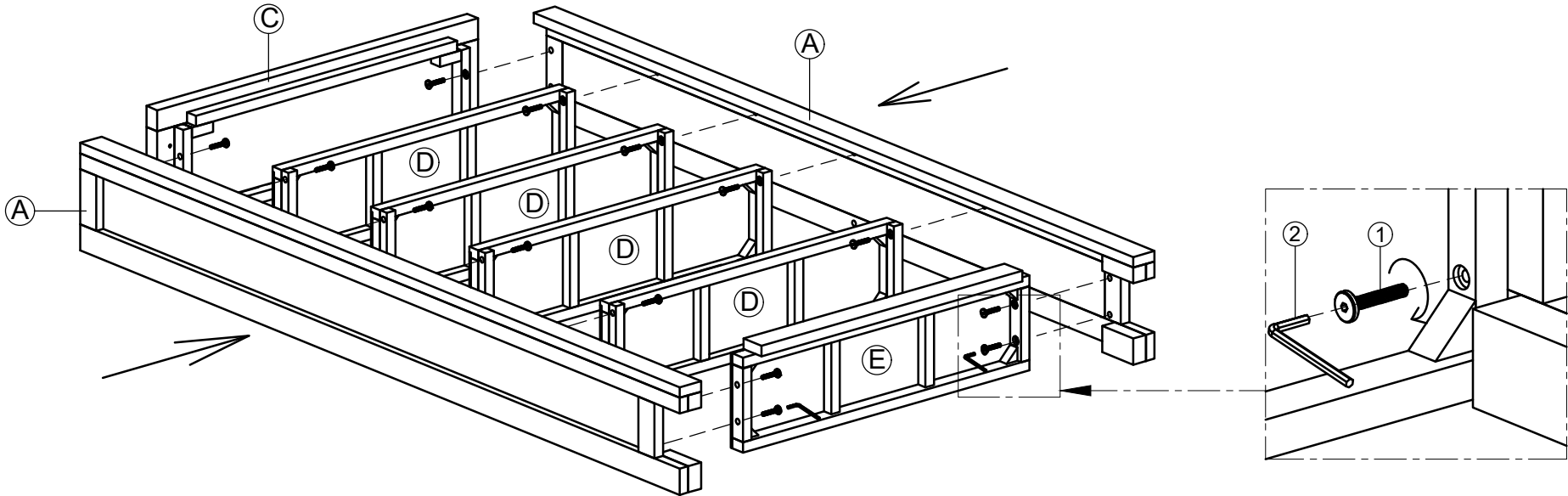

STEP 2

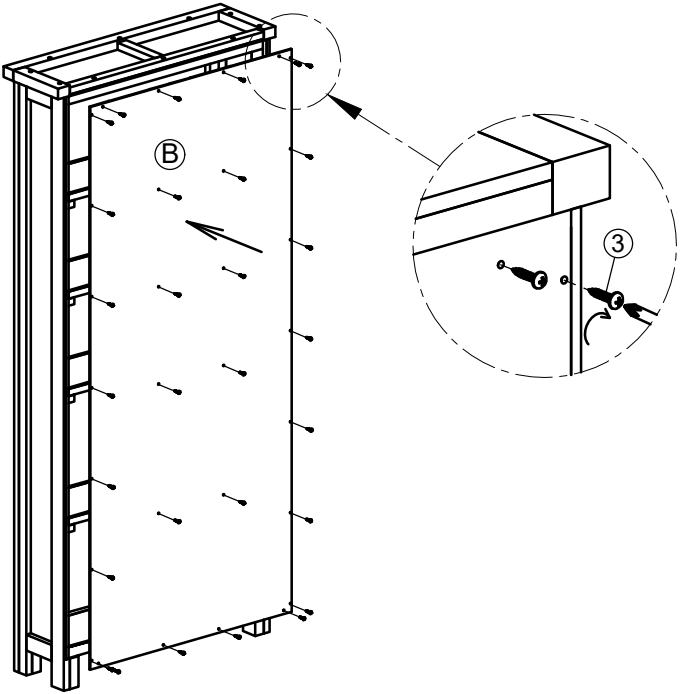

STEP 3

