

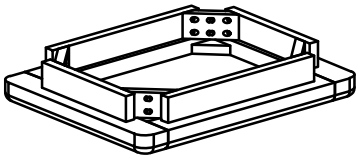

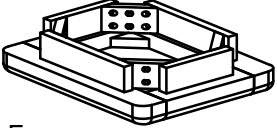
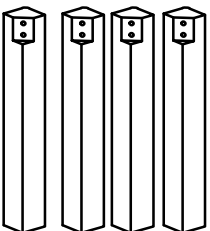
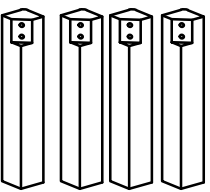

ASSEMBLY INSTRUCTION G7577 - NEST OF TABLE

No	Name of Component	Q.ty
(A)	 Large Frame	1

(B)	 Small Frame	1
-----	--	---

(C)	 Long Legs	4
-----	--	---

(D)	 Short Legs	4
-----	--	---

No	Name of Hardware	Q.ty
(1)	Bolts M6x50 	16
(2)	Spring Washers 	16
(3)	Flat Washers 	16
(4)	Allen key K4 	1

STEP 1

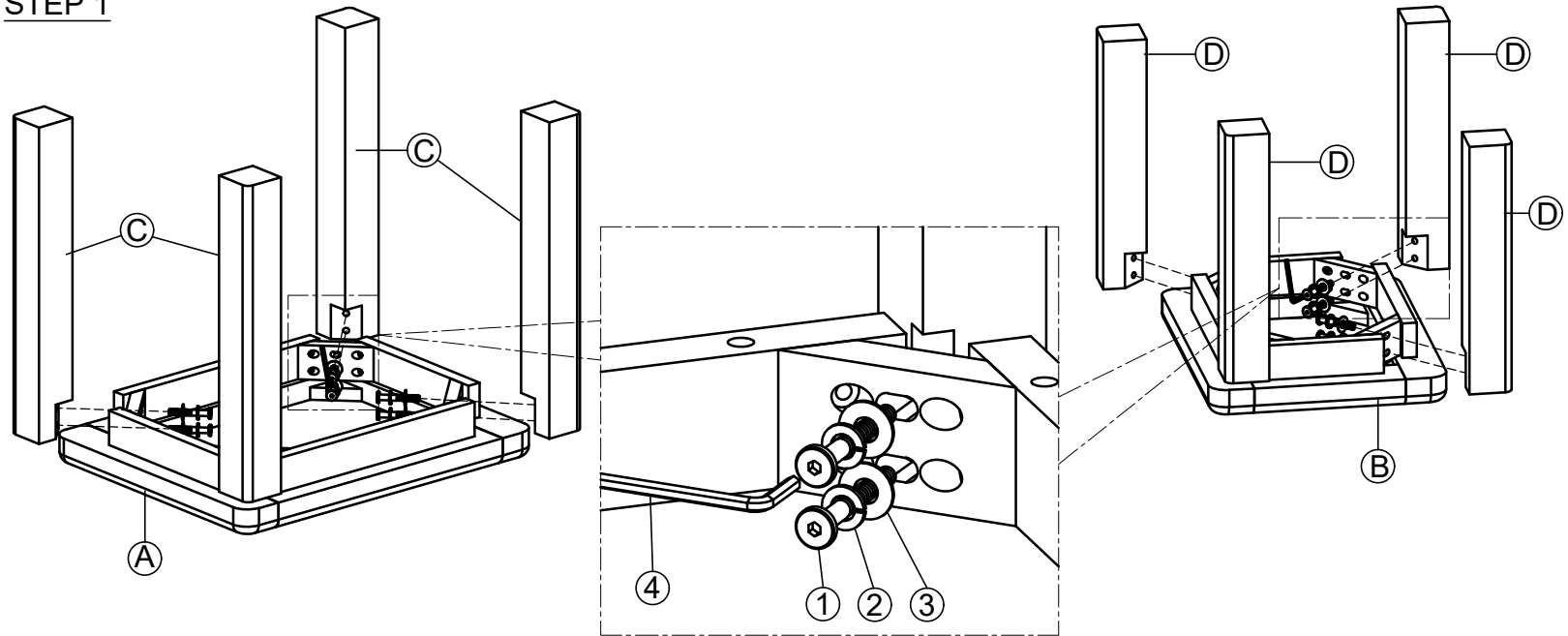

FINAL

