

ASSEMBLY INSTRUCTION

G5742 - CHEST 2 OVER 3

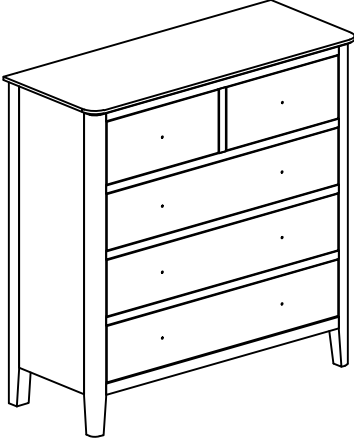
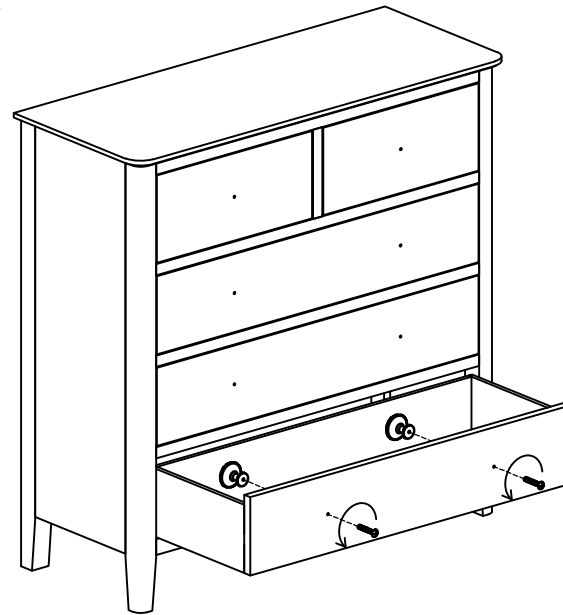

No	Name of Component	Q.ty
A		1

STEP 1



STEP 2



No	Name of Hardware	Q.ty
1	Bracket 	2
2	Tie 	1
3	Screw Ø4 x 20 	2

STEP 3

