

# ASSEMBLY INSTRUCTION G5520 - BOOKCASE

No	Name of Component	Q.ty
(A)	 Legs frame ( Left -Right)	2
(B)	 Shelf B:	1
(C)	 Shelf C:	1
(D)	 Shelf D:	1
(E)	 Shelf E:	1

## STEP: 1

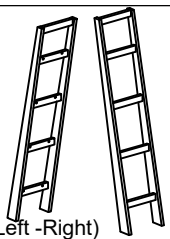

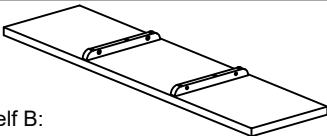
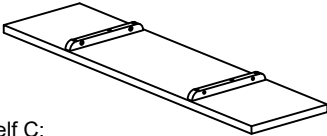
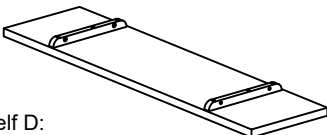
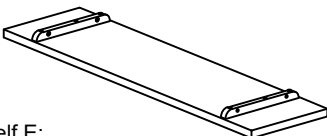
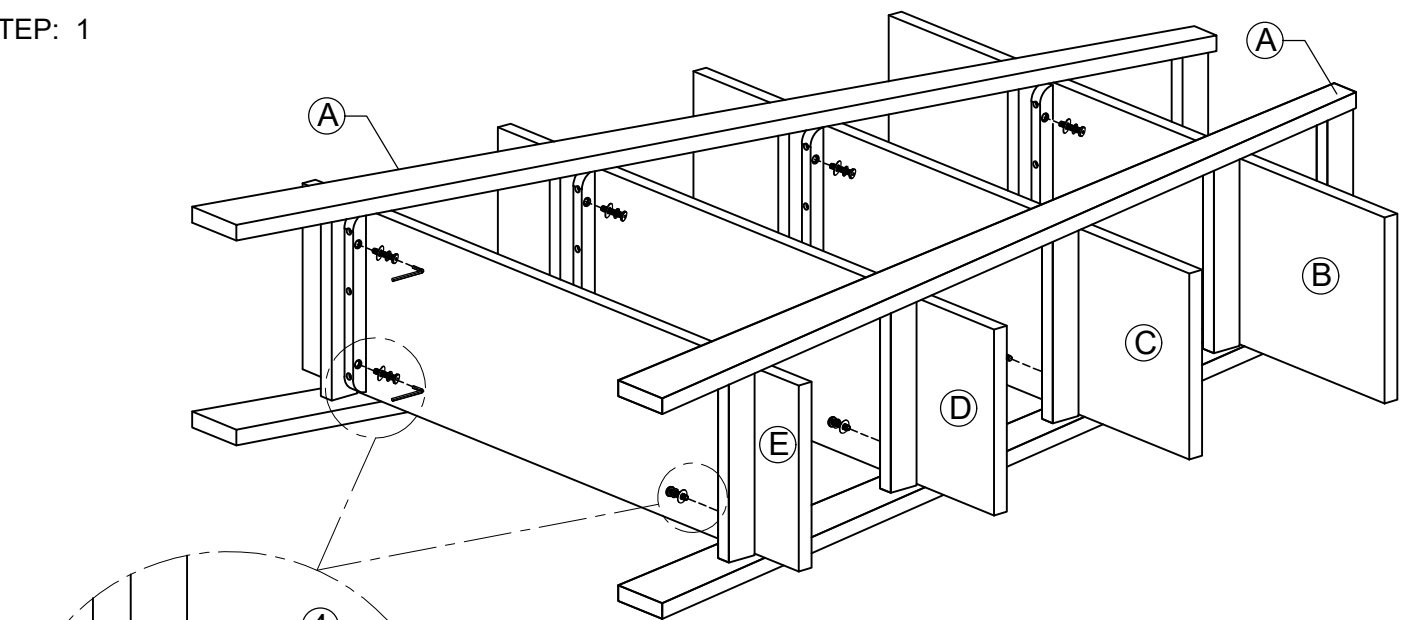

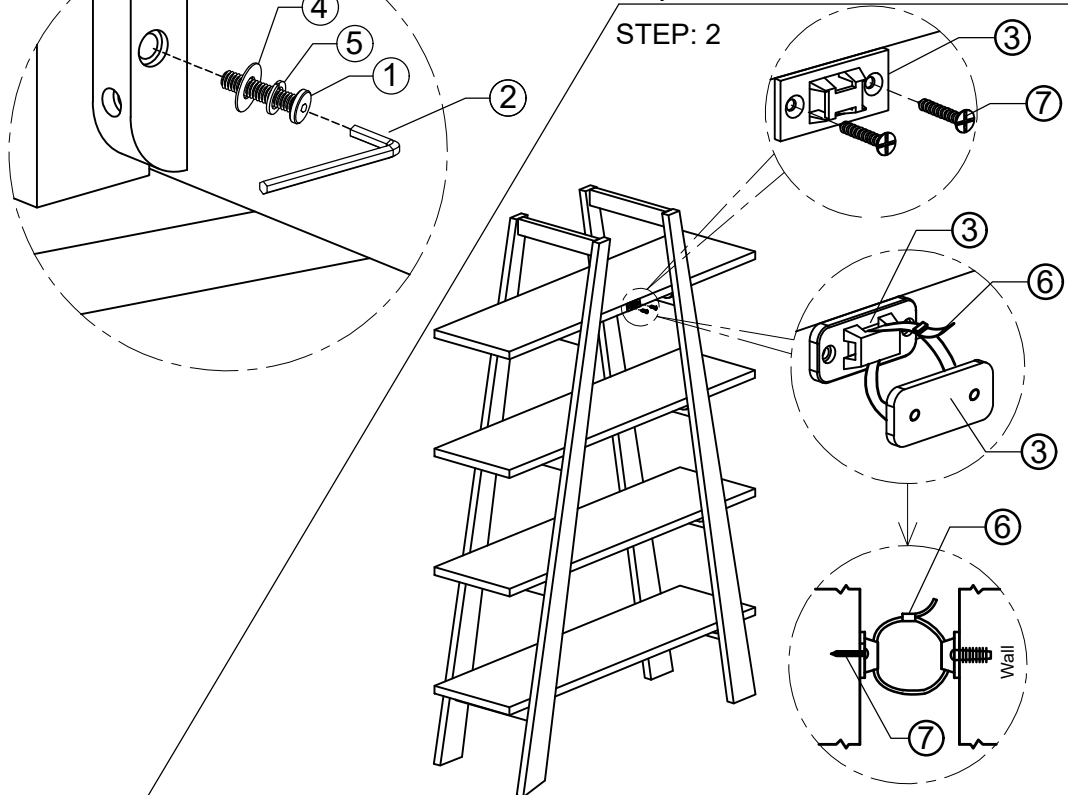

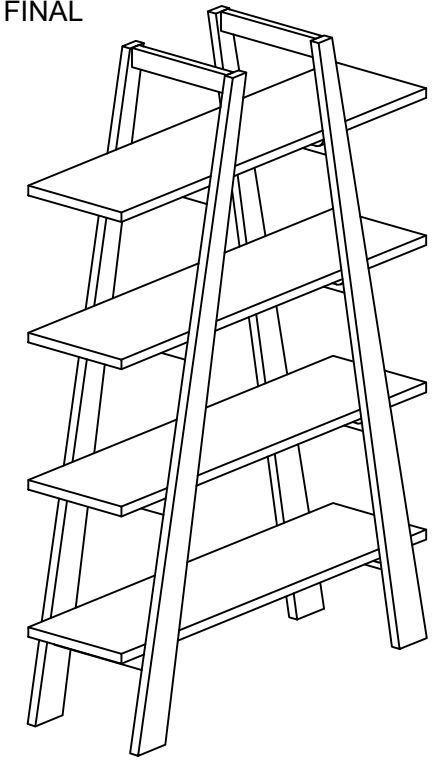

## STEP: 2

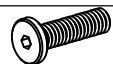
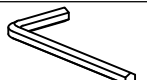

## FINAL



No	Name of Hardware	Q.ty
(1)	Bolt M6 x 30 	16
(2)	Allen key K4 	1
(3)	Plastic bracket 	2
(4)	Flat Washer 1 x 6 x 16 	16
(5)	Spring Washer M6 	16
(6)	Tie 	1
(7)	Screw Ø4x20 	2