

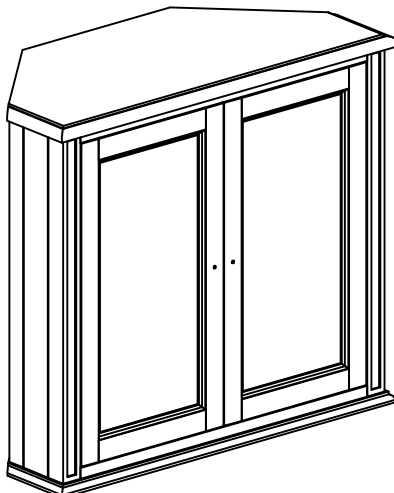





# ASSEMBLY INSTRUCTION G4995 - CORNER CUPBOARD

No.	Part name	Q'ty
A		1
B		2
C		2
No.	Hardware name	Q'ty
1	Handle with Bolt 	2
2	Bracket 	2
3	Tie 	1
4	Screw Ø4x20 	2

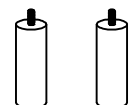
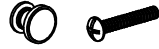
STEP 1    STEP 2

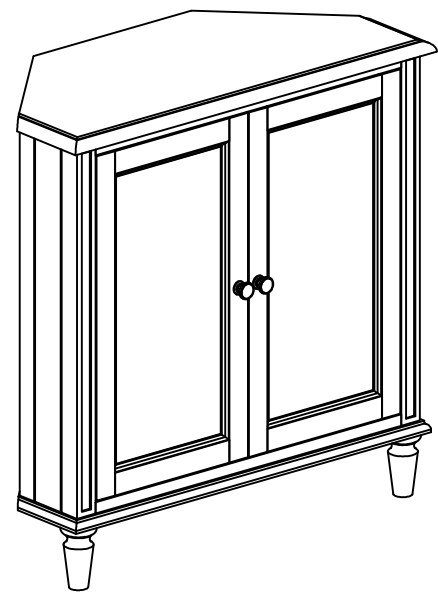
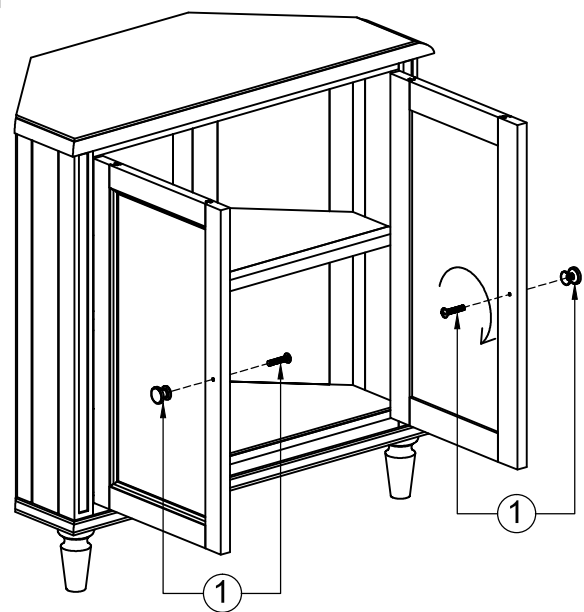
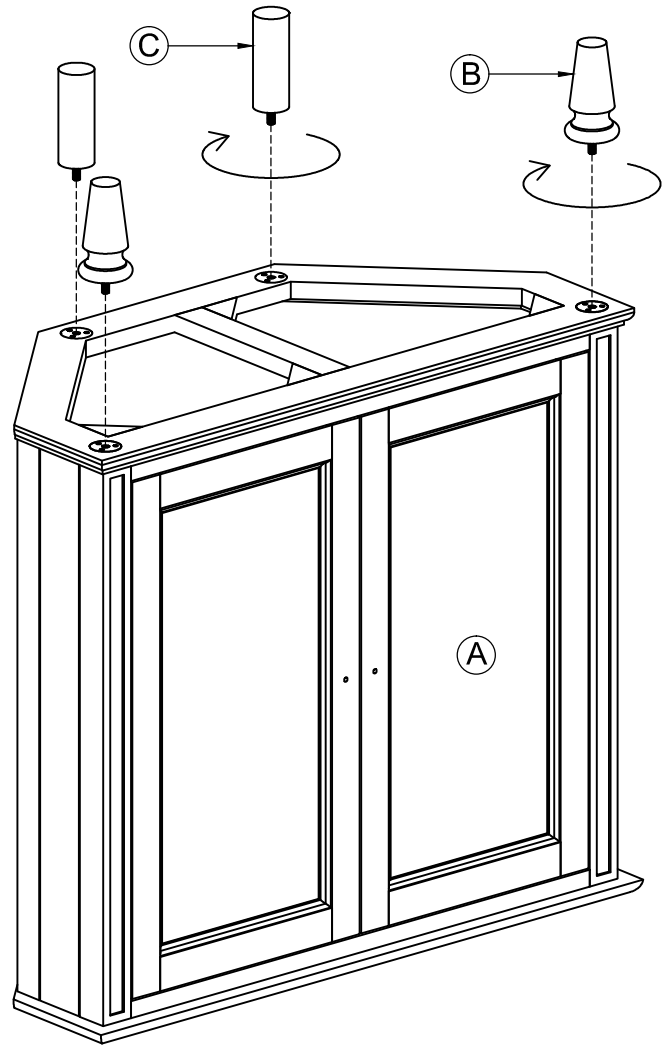

ASSEMBLY INSTRUCTION  
G4995 - CORNER CUPBOARD

STEP 3 STEP 4

