







# ASSEMBLY INSTRUCTION MINI BOOKCASE \_ KD

No	LIST OF HARDWARE	FIG	Q.ty (pcs)
①	Bolts M6x35		16
②	Spring Washers		16
③	Flat Washers		16
④	Allen key K4		1
⑤	Round head Screws Ø3.5x15		10
⑥	Screws Ø4x20		2
⑦	Brackets		2
⑧	Tie		1

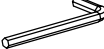
Screwdriver (not included) 

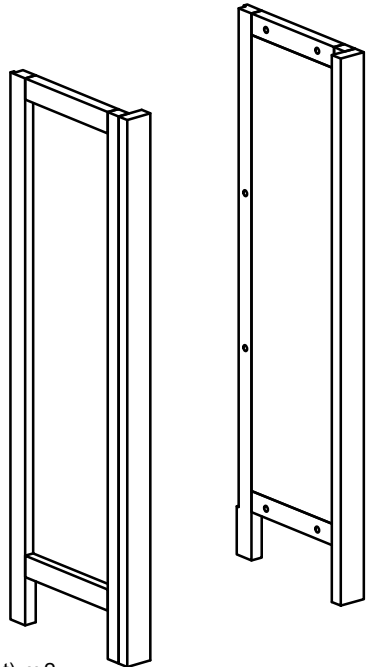

**A** Side frame (Left - Right): x 2

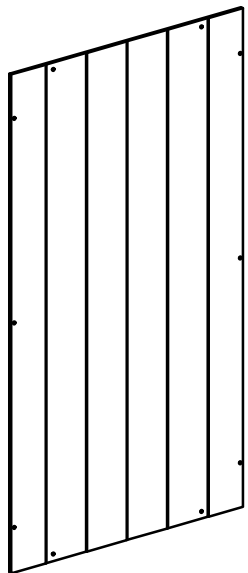

**B** Back panel: x 1

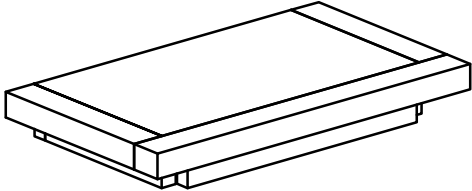
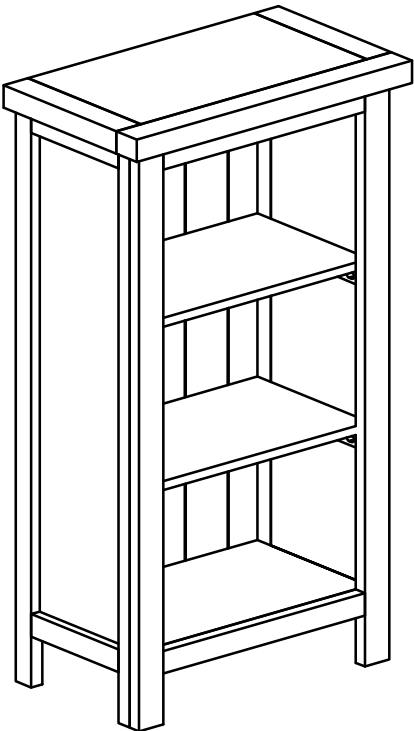

**C** Top Frame: x 1

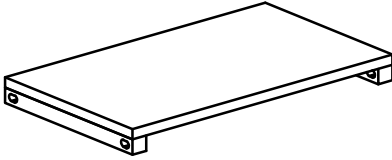

**D** Shelves: x 2

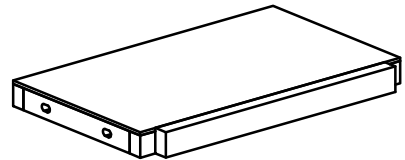

**E** Bottom Frame: x 1

# ASSEMBLY INSTRUCTION MINI BOOKCASE \_KD

## STEP 1

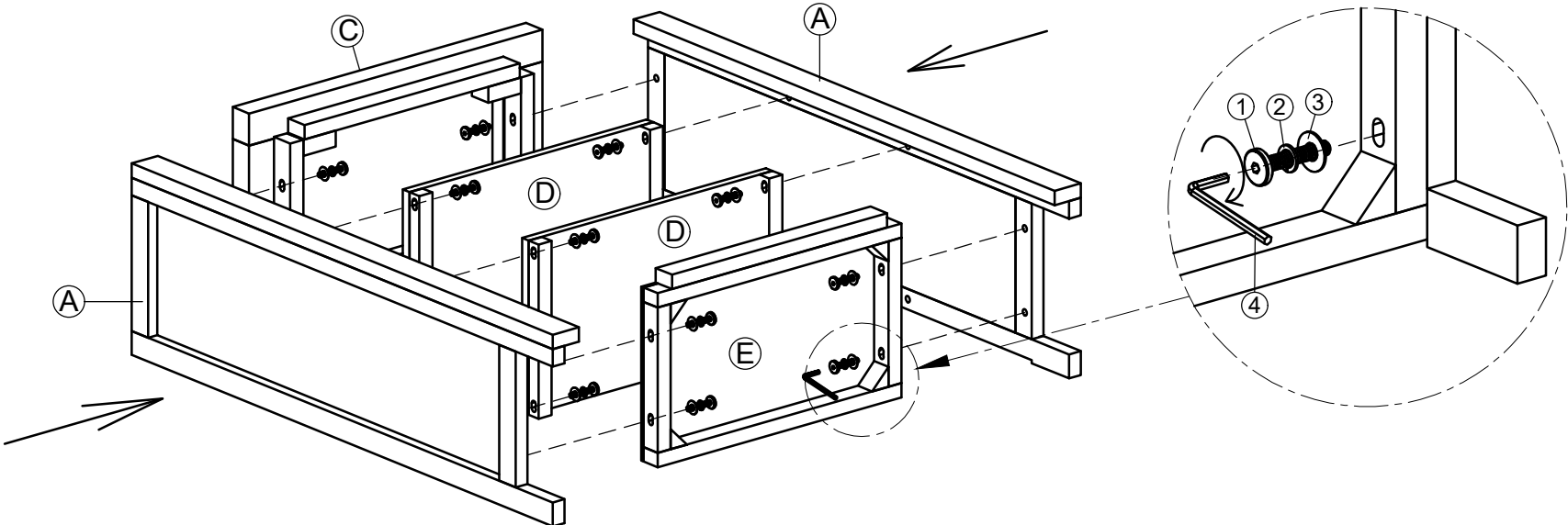

## STEP 2

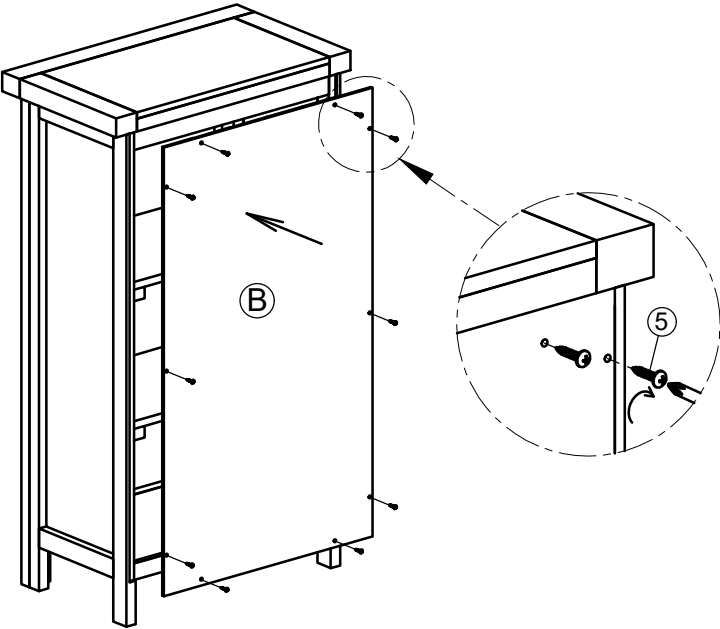

## STEP 3

