







ASSEMBLY INSTRUCTION MINI BOOKCASE _ KD

No	LIST OF HARDWARE	FIG	Q.ty (pcs)
①	Bolts M6x35		16
②	Spring Washers		16
③	Flat Washers		16
④	Allen key K4		1
⑤	Round head Screws Ø3.5x15		10
⑥	Screws Ø4x20		2
⑦	Brackets		2
⑧	Tie		1

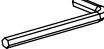
Screwdriver (not included)

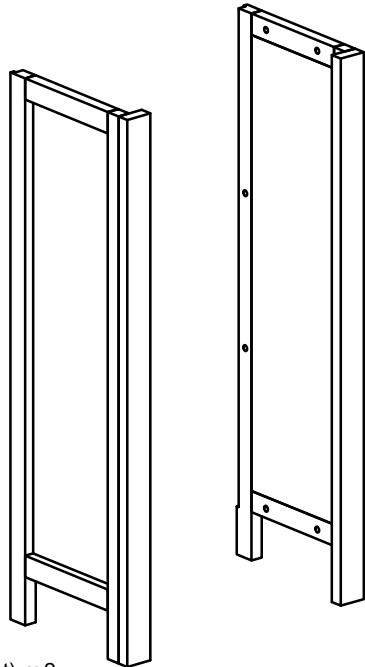
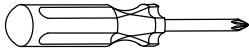

Ⓐ Side frame (Left - Right): x 2

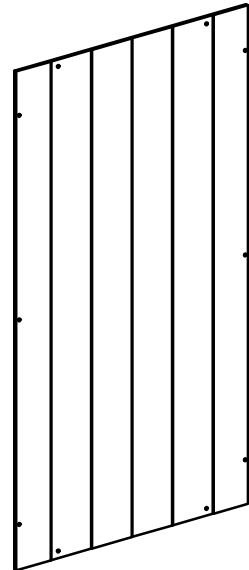

Ⓑ Back panel: x 1

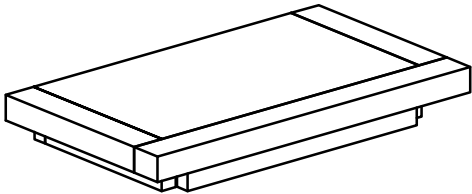
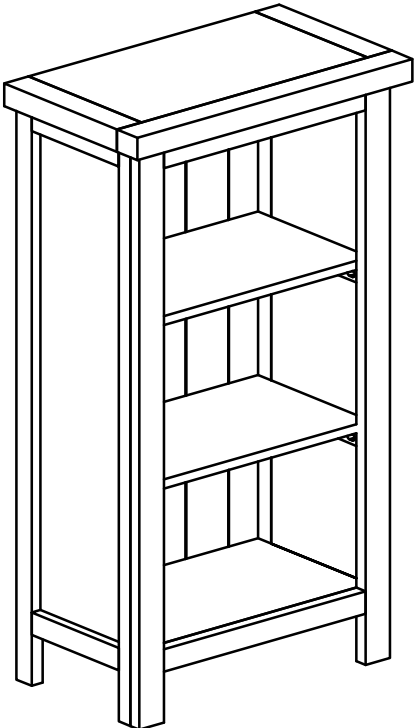

Ⓒ Top Frame: x 1

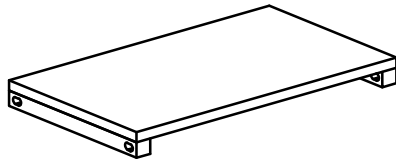

Ⓓ Shelves: x 2

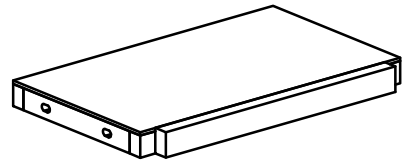

Ⓔ Bottom Frame: x 1

ASSEMBLY INSTRUCTION MINI BOOKCASE _ KD

STEP 1

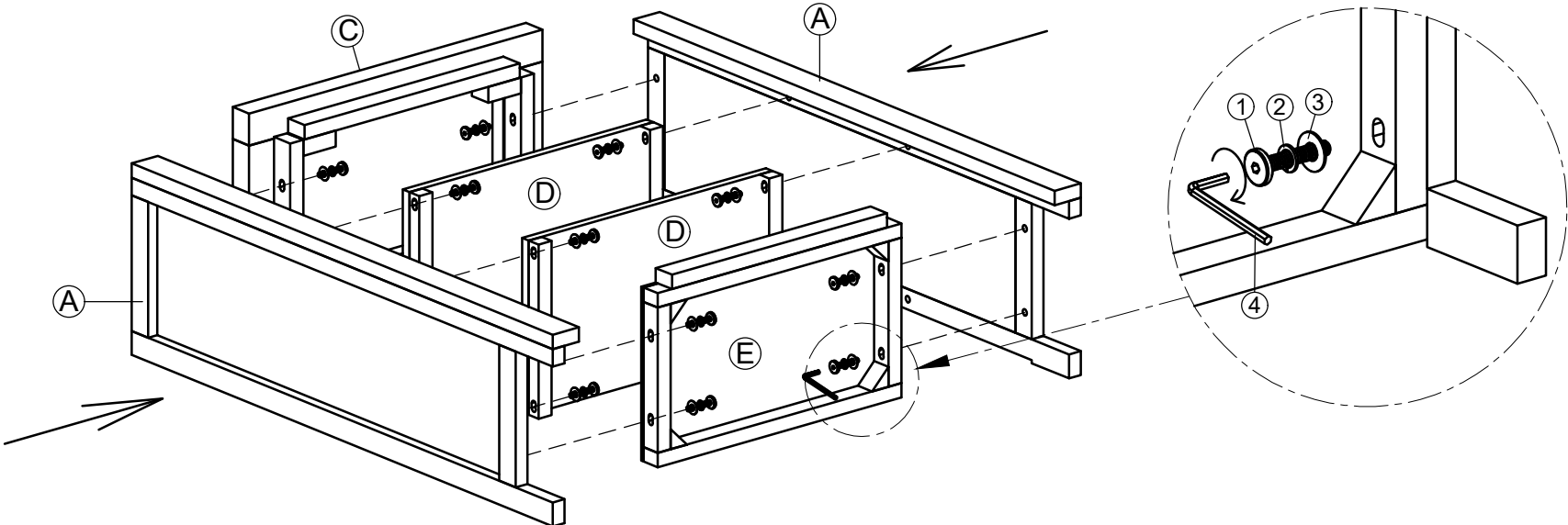

STEP 2

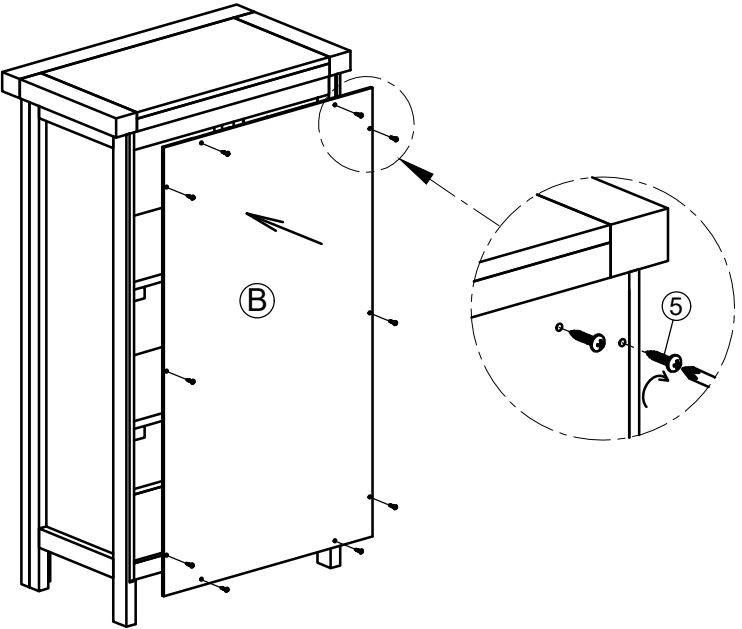

STEP 3

