







ASSEMBLY INSTRUCTION

LOW BOOKCASE _ KD

No	LIST OF HARDWARE	FIG	Q.ty (pcs)
①	Bolts M6x30		16
②	Allen key K4		1
③	Round head Screws Ø3.5x15		14
④	Screws Ø4x20		2
⑤	Brackets		2
⑥	Tie		1
Screwdriver (not included)			

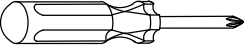
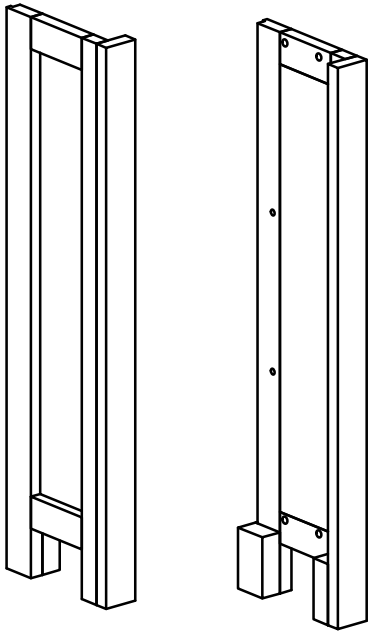

A Side frame (Left - Right): x 2

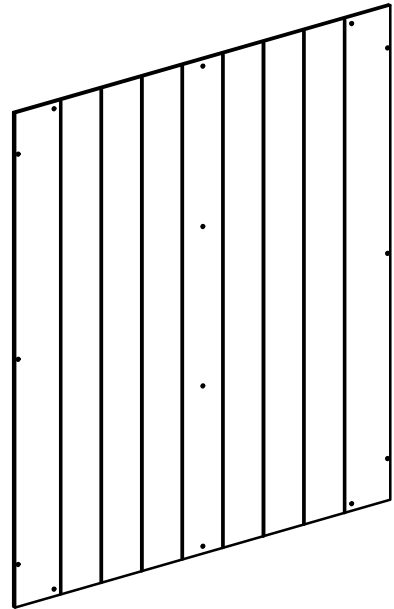

B Back panel: x 1

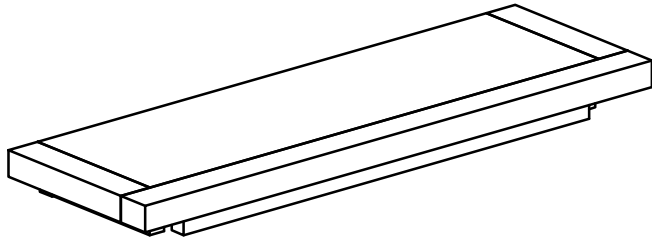
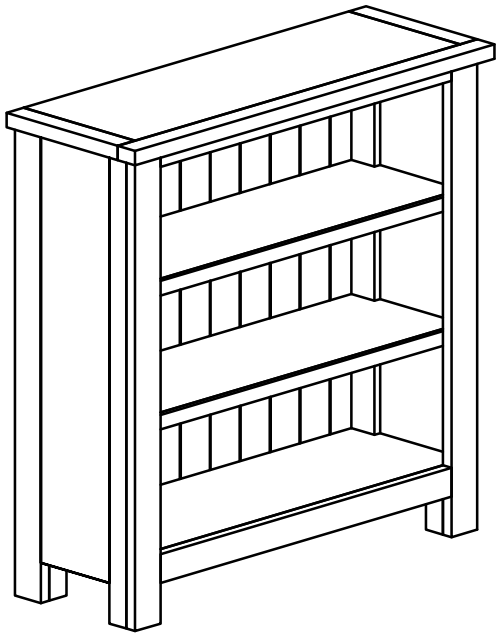

C Top Frame: x 1

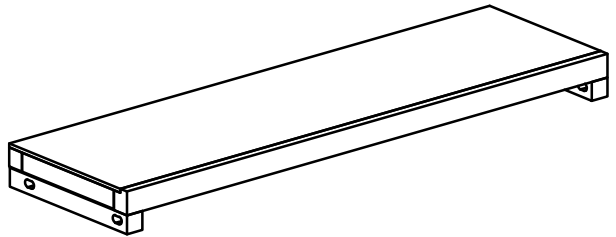

D Shelves: x 2

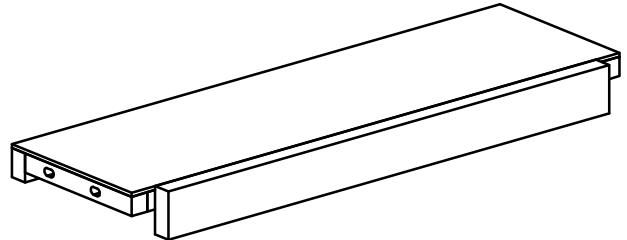

E Bottom Frame: x 1

ASSEMBLY INSTRUCTION LOW BOOKCASE _ KD

STEP 1

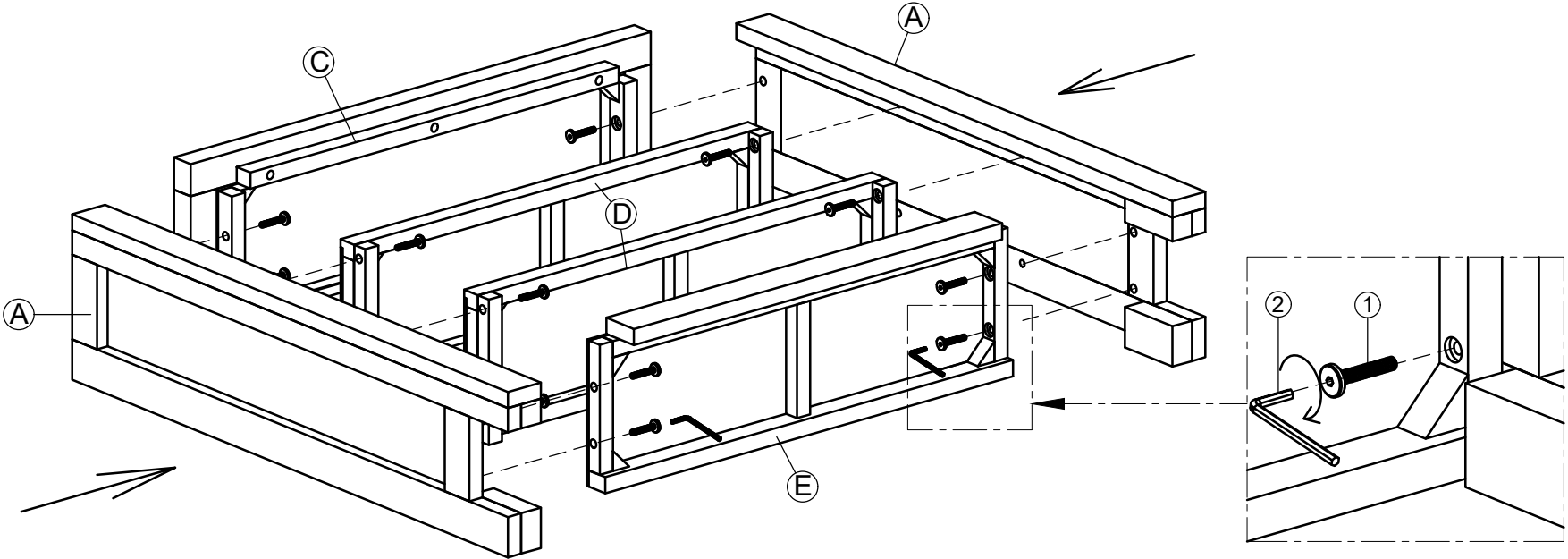

STEP 2

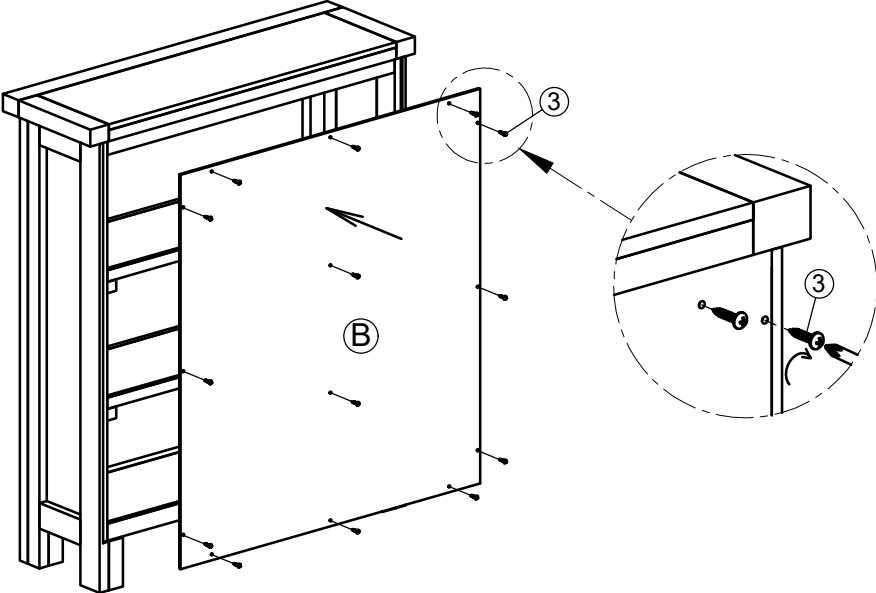

STEP 3

