







ASSEMBLY INSTRUCTION SLIM BOOKCASE _ KD

No	LIST OF HARDWARE	FIG	Q.ty (pcs)
①	Bolts M6x35		24
②	Spring Washers		24
③	Flat Washers		24
④	Allen key K4		1
⑤	Round head Screws Ø3.5x15		22
⑥	Screws Ø4x20		2
⑦	Brackets		2
⑧	Tie		1

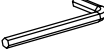
Screwdriver (not included) 

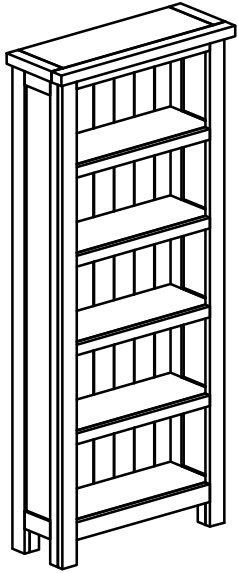

Ⓐ Side frame (Left - Right): x 2

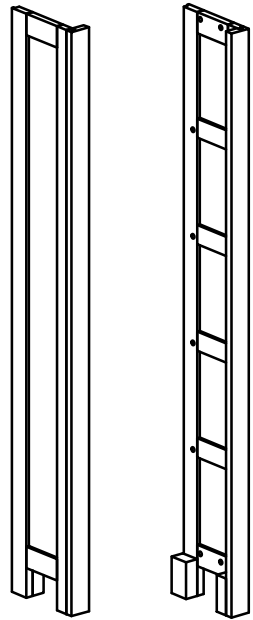

Ⓑ Back panel: x 1

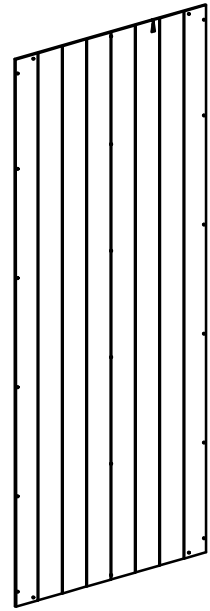

Ⓒ Top Frame: x 1

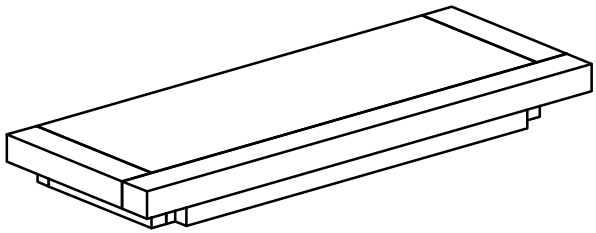

Ⓓ Shelves: x 4

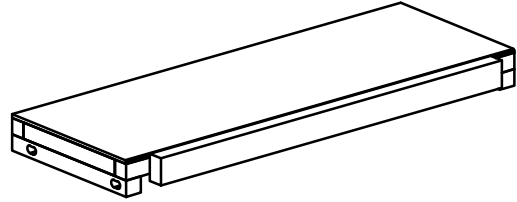

Ⓔ Bottom Frame: x 1

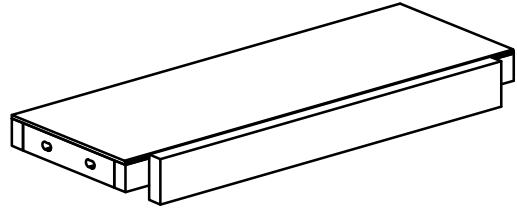

ASSEMBLY INSTRUCTION SLIM BOOKCASE _ KD

STEP 1

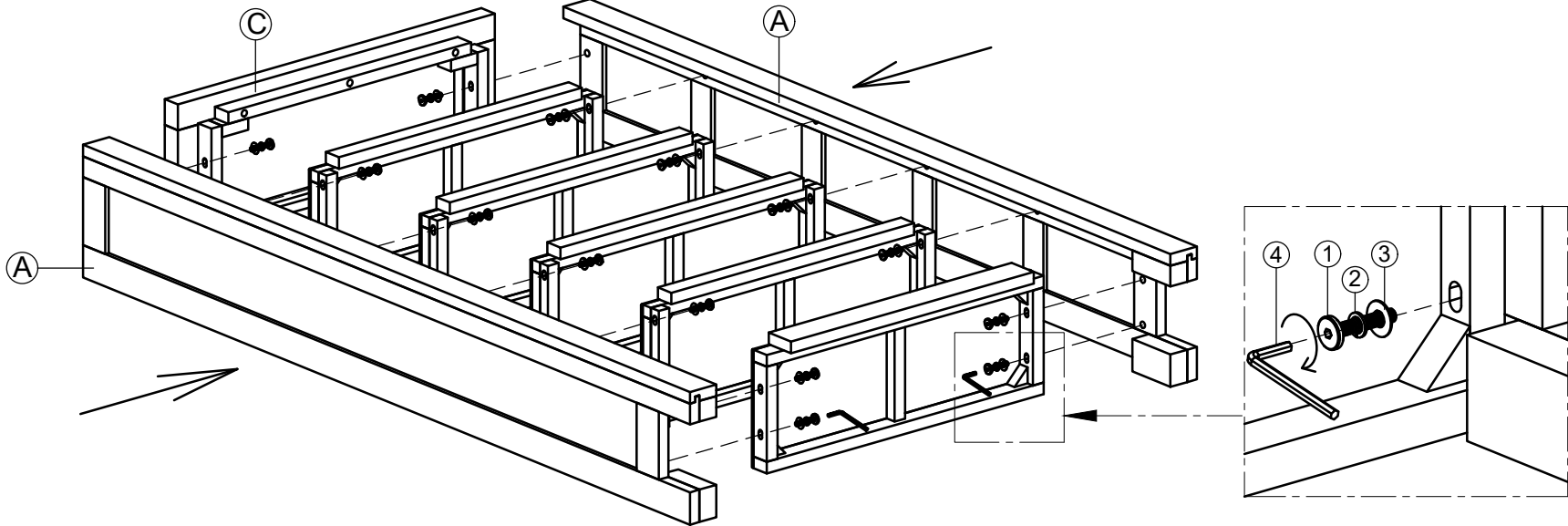

STEP 2

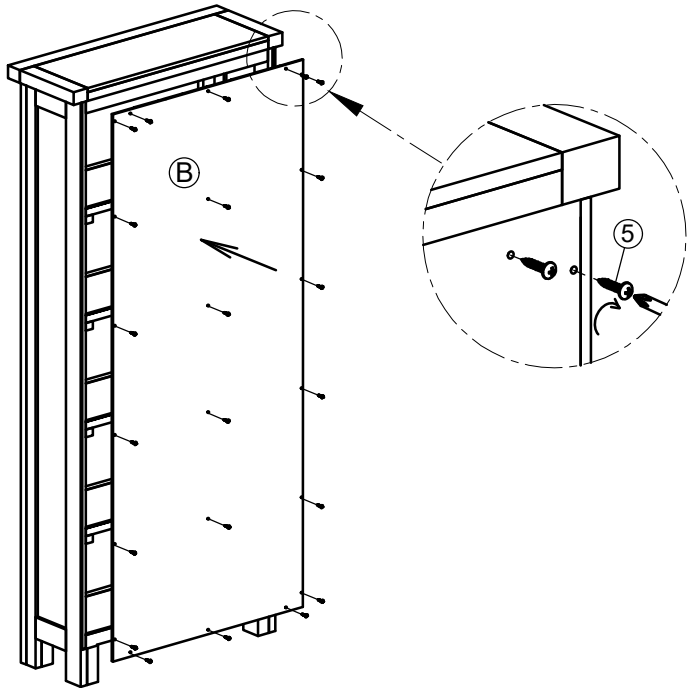

STEP 3

