







# ASSEMBLY INSTRUCTION

## LOW BOOKCASE \_ KD

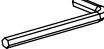
No	LIST OF HARDWARE	FIG	Q.ty (pcs)
①	Bolts M6x35		16
②	Spring Washers		16
③	Flat Washers		16
④	Allen key K4		1
⑤	Round head Screws Ø3.5x15		14
⑥	Screws Ø4x20		2
⑦	Brackets		2
⑧	Tie		1

Screwdriver (not included) 

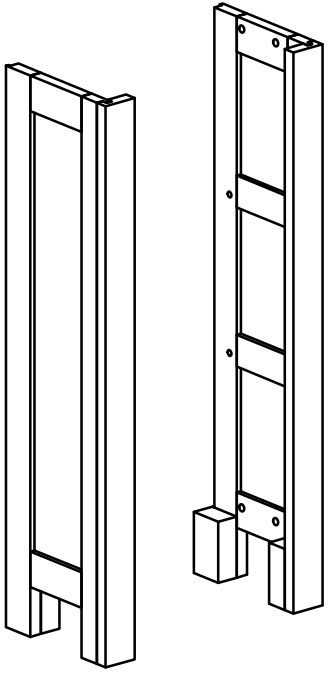

Ⓐ Side frame (Left - Right): x 2

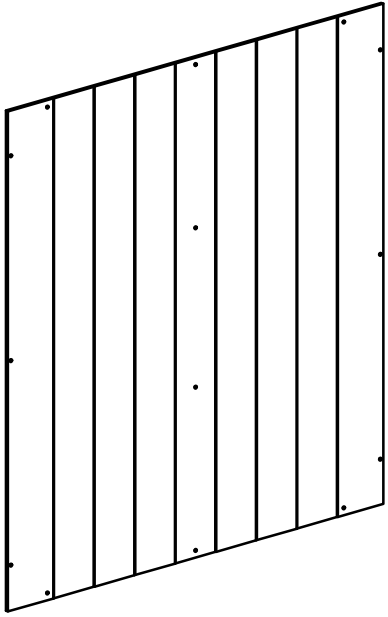

Ⓑ Back panel: x 1

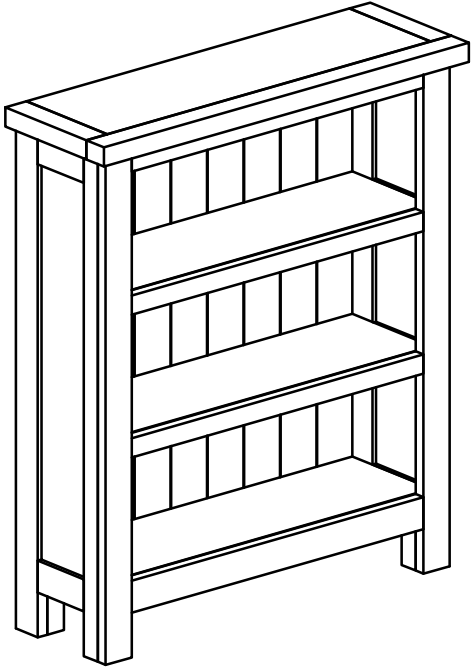

Ⓒ Top Frame: x 1

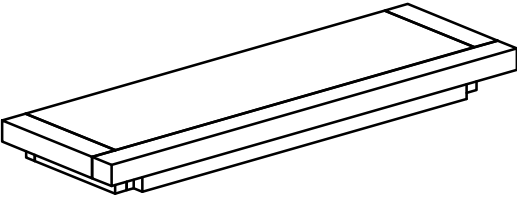

Ⓓ Shelves: x2

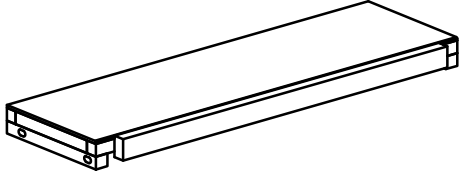

Ⓔ Bottom Frame: x 1

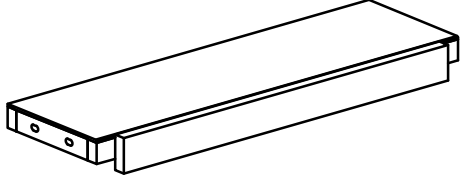

# ASSEMBLY INSTRUCTION LOW BOOKCASE \_KD

## STEP 1

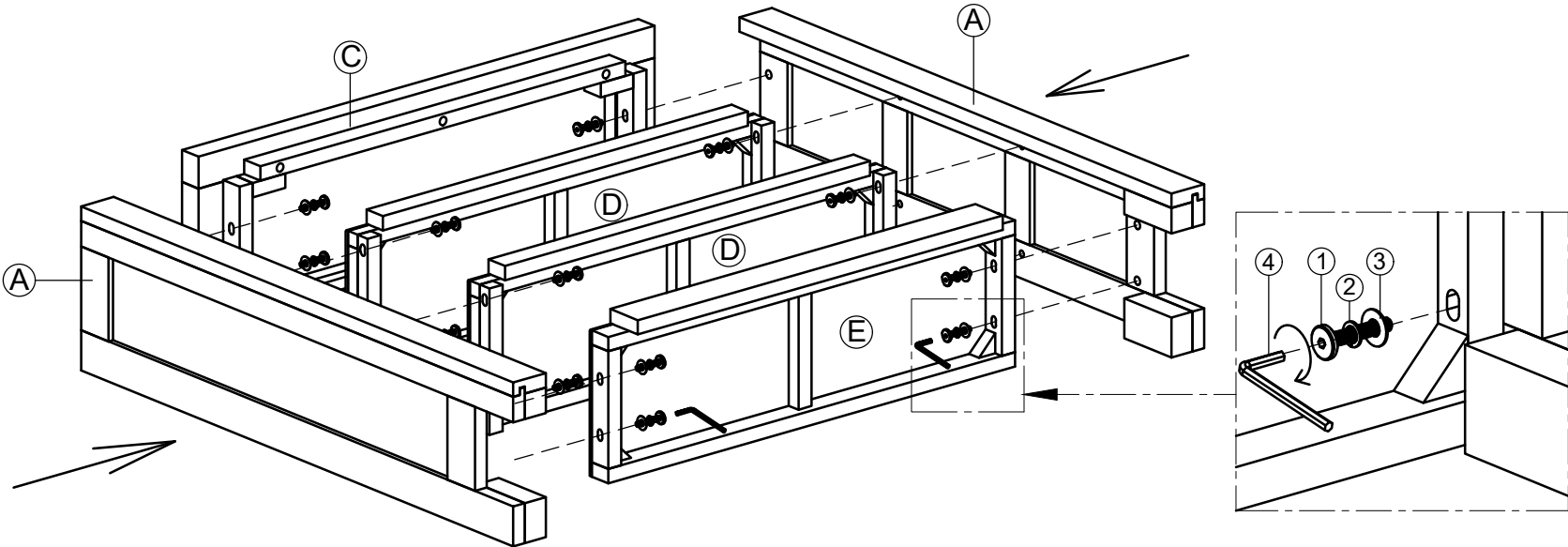

## STEP 2

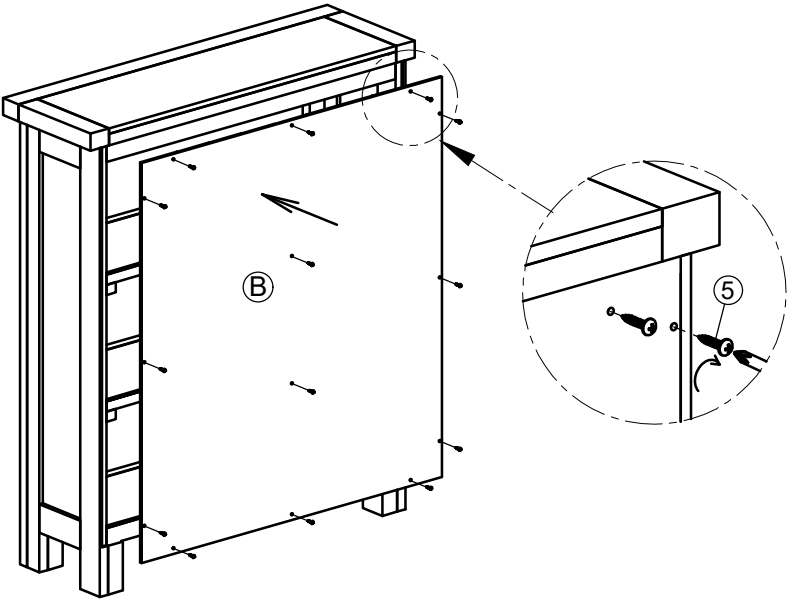

## STEP 3

