

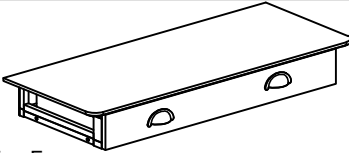









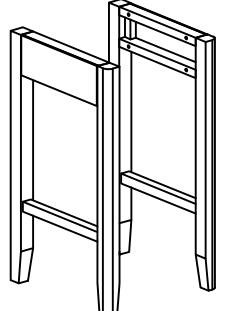
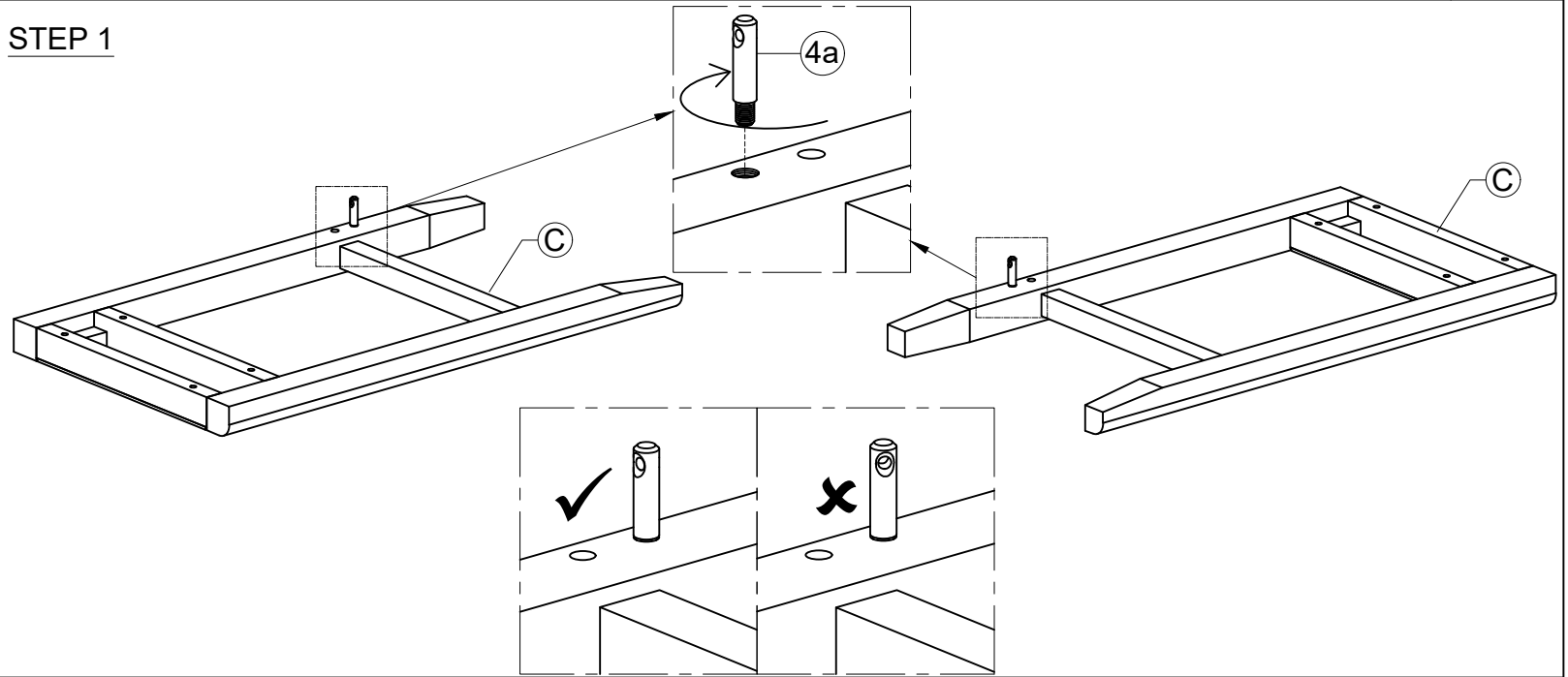

ASSEMBLY INSTRUCTION

G5732 - HOME OFFICE DESK

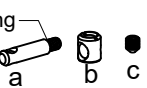
No	Name of Component	Q.ty
(A)	 Top Frame:	1
(B)	 Stretcher:	1
(C)	 Leg Frame: (left - Right)	2

STEP 1



No	Name of Hardware	Q.ty
(1)	Bolt M6 x 40 	4
(2)	Bolt M6 x 60 	4
(3)	Washer Ø7/Ø15 x 1 	8
(4)	Connecting system  Ruber O ring	2
(5)	Allen key K4 	1
(6)	Allen key K5 	1
(7)	Bracket 	2
(8)	Tie 	1
(9)	Screw M4 x 20 	2

STEP 2

Take out the drawer

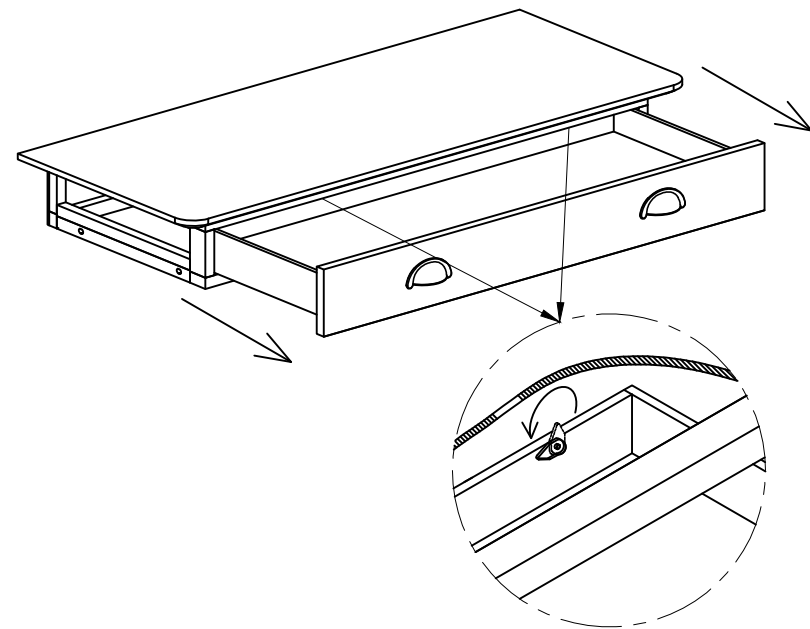

ASSEMBLY INSTRUCTION G5732 - HOME OFFICE DESK

STEP 3

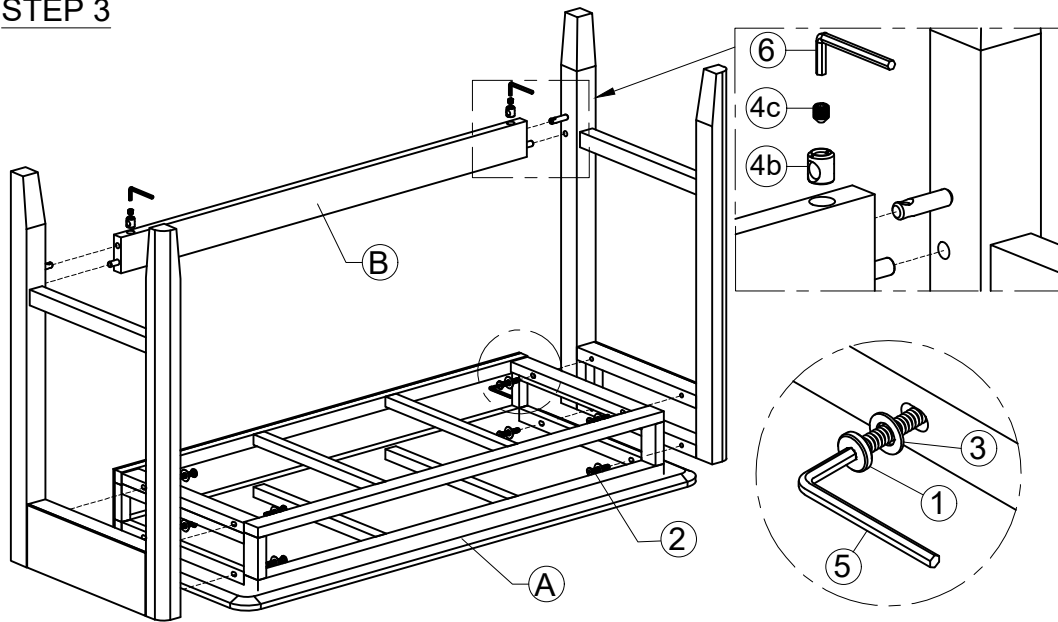

STEP 4

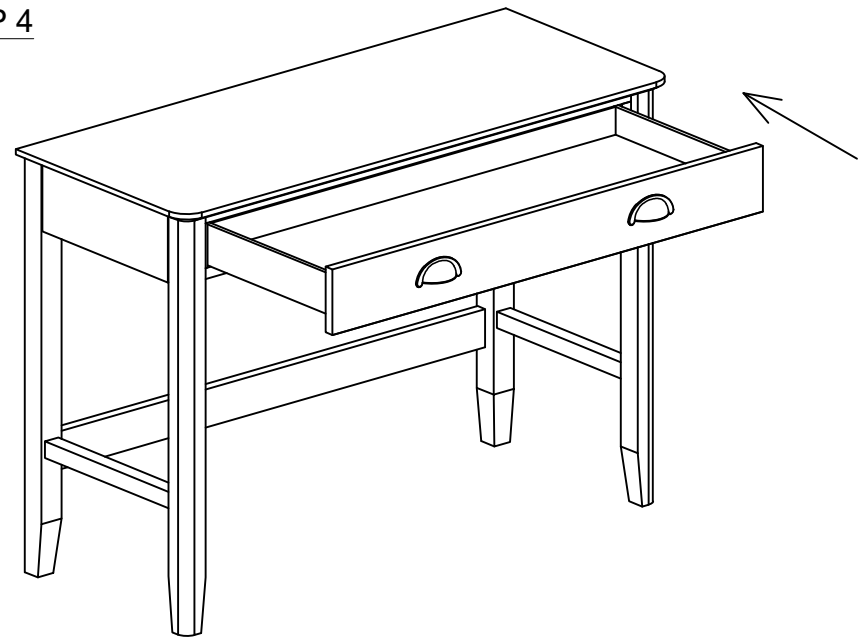

STEP 5

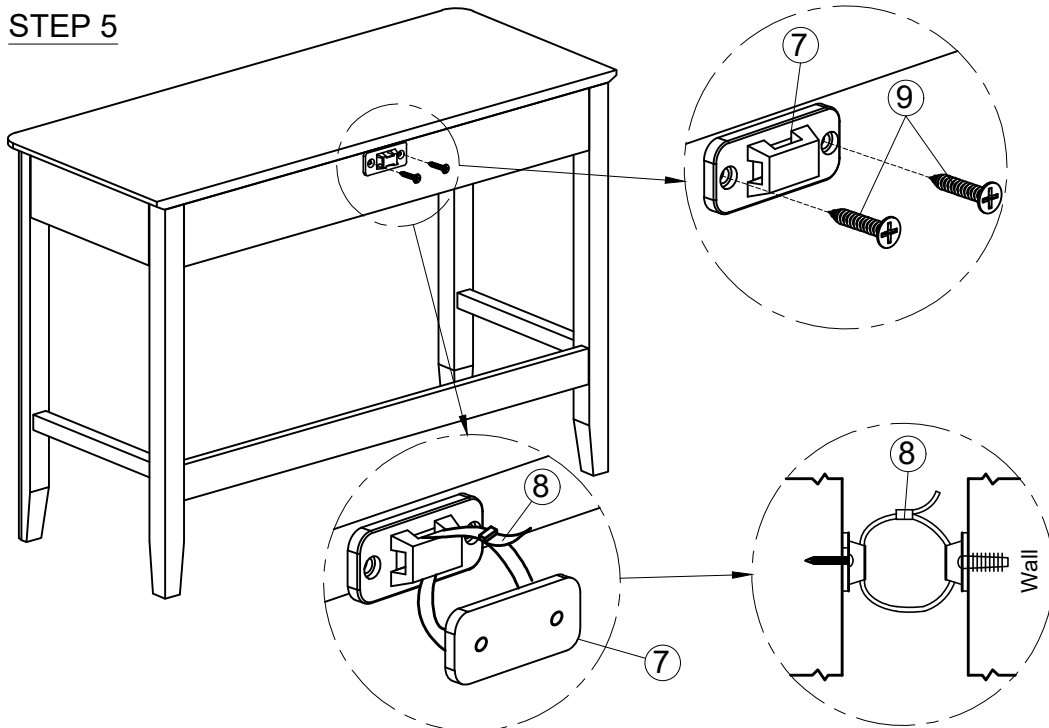

FINAL

