







ASSEMBLY INSTRUCTION

LOW BOOKCASE _ KD

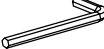
No	LIST OF HARDWARE	FIG	Q.ty (pcs)
①	Bolts M6x35		16
②	Spring Washers		16
③	Flats Washers		16
④	Allen key K4		1
⑤	Round head Screws Ø3.5x15		20
⑥	Screws Ø4x20		2
⑦	Brackets		2
⑧	Ties		1

Screwdriver (not included) 

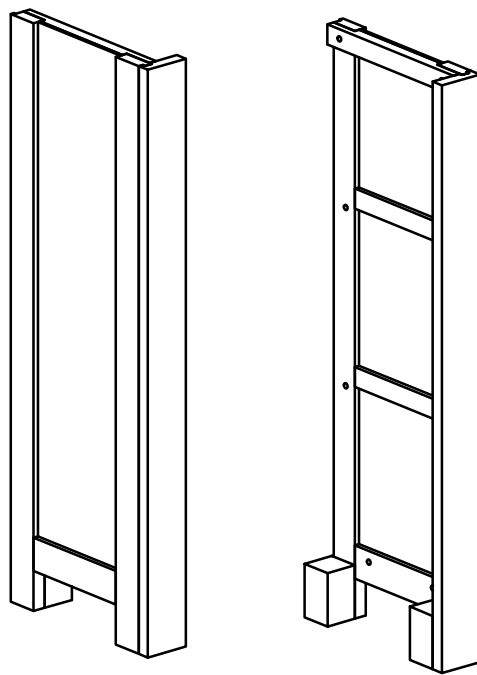

Ⓐ Side frame (Left - Right): x 2

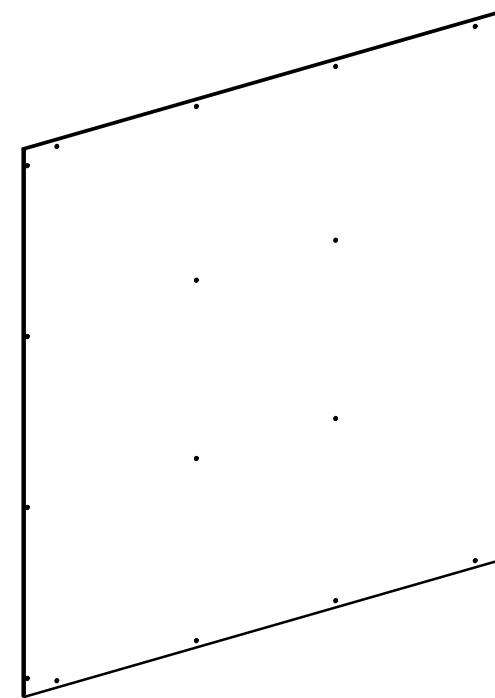

Ⓑ Back panel: x 1

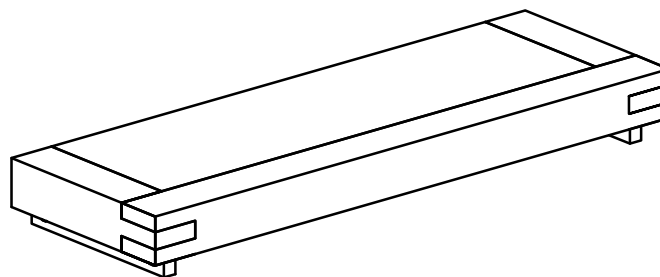
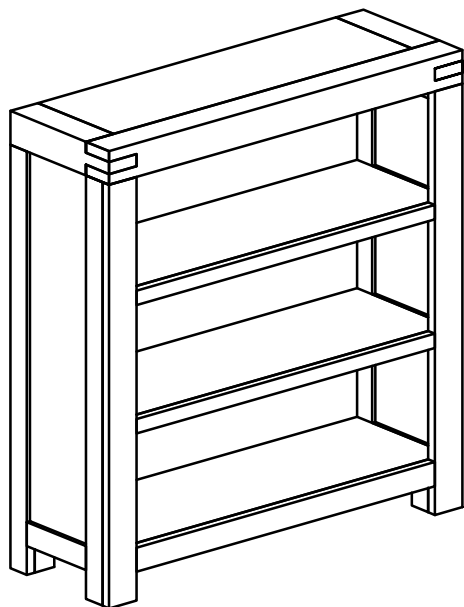

Ⓒ Top Frame: x 1

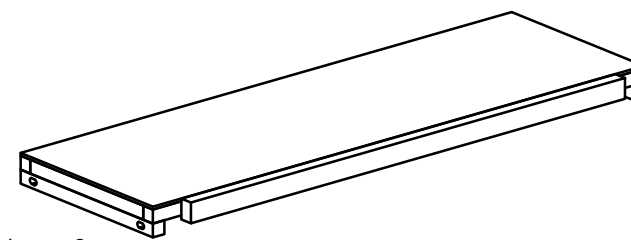

Ⓓ Shelves: x 2

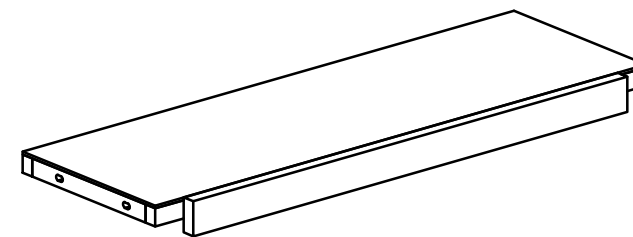

Ⓔ Bottom Frame: x 1

ASSEMBLY INSTRUCTION LOW BOOKCASE _ KD

STEP 1

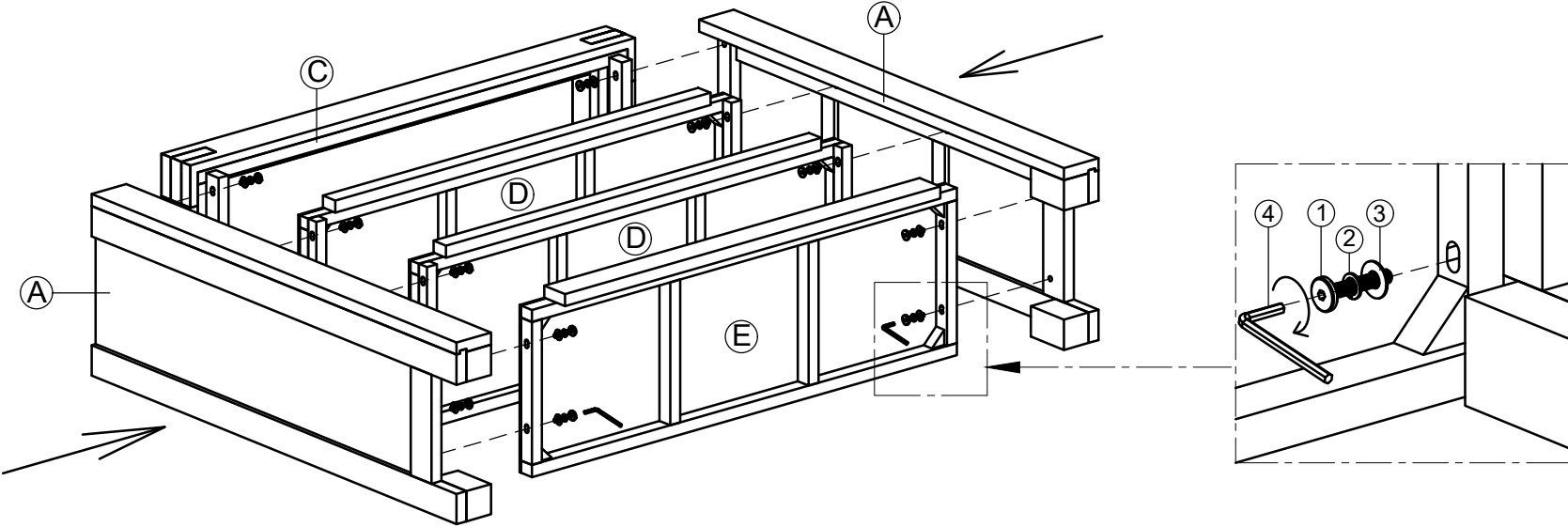

STEP 2

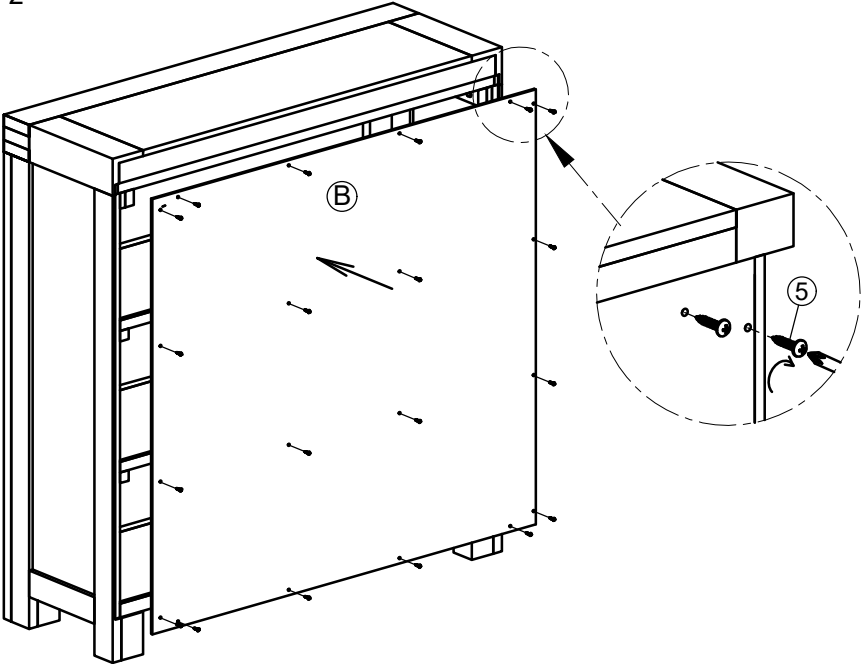

STEP 3

