

Product size: L140\*W80\*H70 cm



**Furniture should be covered/stored whilst not in use to prolong its longevity.  
(It should also be covered in adverse weather. )**

*The frame of this product is manufactured from mild steel coated with a weather resistant paint. Steel has a natural tendency to rust over time and, whilst we expect you to be able to enjoy your furniture for many years to come, we recommend that you check the product from time to time for signs of paint damage and/ or rust. If the paint should become damaged, or if rust begins to form, you should clean the affected area and apply a suitable "thinners based" touch-up paint. Such paints are readily available from all good hardware and DIY stores.*

The intended use of this product is for domestic use only.

Important, please retain for future reference.

Read carefully.

## Before you start



### Warnings

#### IMPORTANT, RETAIN FOR FUTURE REFERENCE READ CAREFULLY

See enclosed instructions for assembly, safety and care information.

Failure to follow the warnings could result in serious injury.

Handle heavy parts with care.

Ensure that this product is fully assembled as illustrated before use.

This product should only be used on firm, level ground.

#### Keep small parts out of reach of children.

This product is intended for **domestic use** only.

Ensure the product is always placed on level ground.

Furniture can be dangerous if incorrectly used. No liability will be accepted for damage or injury caused by incorrect use of this product.

### ✓ Dos

When you are ready to start, make sure that you have the right tools, plenty of space and a clean, dry area for assembly.

Unwrap all packaging materials and place the components on a suitable surface to prevent scratching your product.

Check all contents are present prior to assembly as per the parts list provided. In the event of problems or missing parts, please contact the seller.

Check all screws and bolts are tightened and inspect regularly.

Cover furniture when not in use to add additional protection to your product.

During severe weather conditions, including high winds, rain, hail, thunderstorms, extreme heat and cold temperatures, the product should be stored inside in a cool, dry place.

To best preserve this product, please use a protective cover when your furniture is not in use. We would also recommend using a gazebo or parasol over your furniture during the summer period and prolonged sunny spells. This will help prevent harmful UV rays from damaging and discolouring the material.

Frames are manufactured using powder coated steel tubing. When steel is exposed to the air and moisture it will rust. Any scratches on the paintwork should be touched up immediately with metal paint to prevent corrosion.

Ensure that the product is clean and dry before storage.

Clean your product with a sponge and warm soapy water then wipe with a clean, dry cloth.

When cleaning glass panels use a damp cloth or leather with washing up liquid or soft soap if necessary

Where instructions as to the; storage, commissioning, installation, use and maintenance of the goods or (if there is none) good trade practice are not followed and a defect arises this will void the 12 month manufacturer's guarantee on the product.

### ✗ Don'ts

Do not use scourers, abrasives, washing powders, chemical cleaners or any other substances containing abrasives since these substances can damage the product, including the glass panel.

To preserve the table top design do not place greasy / oily items directly onto the surface. Use place-mats to prevent spillages of food or drink.

Do not place very hot or very cold items on the glass surface unless adequately thick table-mats are used to prevent such items from coming into contact with the glass.

Do not use the table as a chopping surface.

Do not strike the table with hard or pointed items.

Do not sit or lean on the table.

Do not use power tools to construct this product.

Do not use this product if parts are missing, damaged or worn.

Do not stand or climb onto the product and do not use it as a ladder, as this could lead to it unbalancing and overturning.

Never drag furniture when moving it, always lift it.

### Number of people required for assembly

Two people



### Time to assemble



30 Minutes

### Tools required

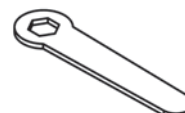
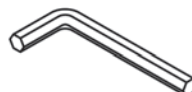

### Tips:

**Do NOT fully tighten bolts before all components are connected. Only fully tighten once you are satisfied with the alignment of all components.**

**Do not over-tighten the bolts.**

[www.royalcraft.co.uk](http://www.royalcraft.co.uk)







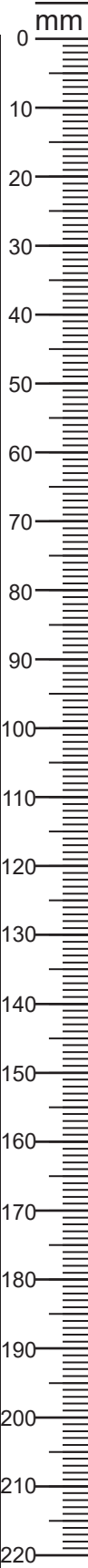

# Amalfi Ivory 140cm x 80cm Glass Table

## Assembly Instructions

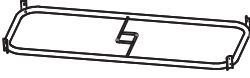
Components, fixtures & fittings (not actual size)

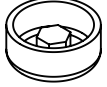
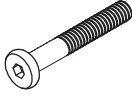

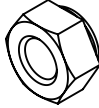
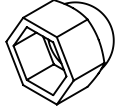
### Parts List

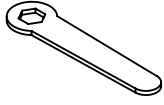
Part No.	Diagram	Qty.	Part No.	Diagram	Qty.
A	 Table Top	1 PC	B	 Table Leg	4 PCS
C	 Connecting Ring	1 PC	D	 M6*32mm Bolt	4 PCS
E	 Bolt Head Cap	8 PCS	F	 M6*55mm Bolt	4 PCS
G	 Washer	8 PCS	H	 Nut	8 PCS
I	 Nut Cap	8 PCS	J	 Parasol Hole Cap (Pre-Assembled)	1 PC
K	 Allen Key	1 PC	L	 Spanner	1 PC

### Step by step assembly instructions

**Note:** Tighten only enough to hold parts in place. Do not tighten completely during assembly. Some adjustments may be necessary to ensure all parts are aligned properly. Only tighten the bolts when all bolts and washers are in place.

#### Step One

With the help of another person, place Table Top (A) upside down on a flat, non-abrasive surface to avoid scratching the table surface or rim. Locate the assembly position on the bottom side of the Table Top (A). It is a plastic socket. Attach the Table Legs (B) onto the assembly position.

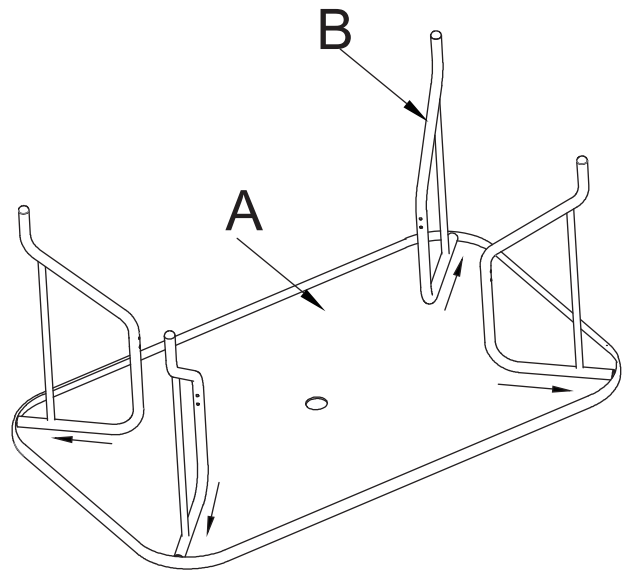

#### Step Two

Place the Connecting Ring (C) onto the Table Legs (B), using Bolt Head Caps (E), Bolts (D&F), Flat Washers (G), Nuts (H) and Nut Caps (I).

Once you are satisfied with the alignment of the components, carefully tighten all bolts using Allen Key (K) and Spanner (L). Do not over-tighten. Cover each bolt with Bolt Head Cap (E).

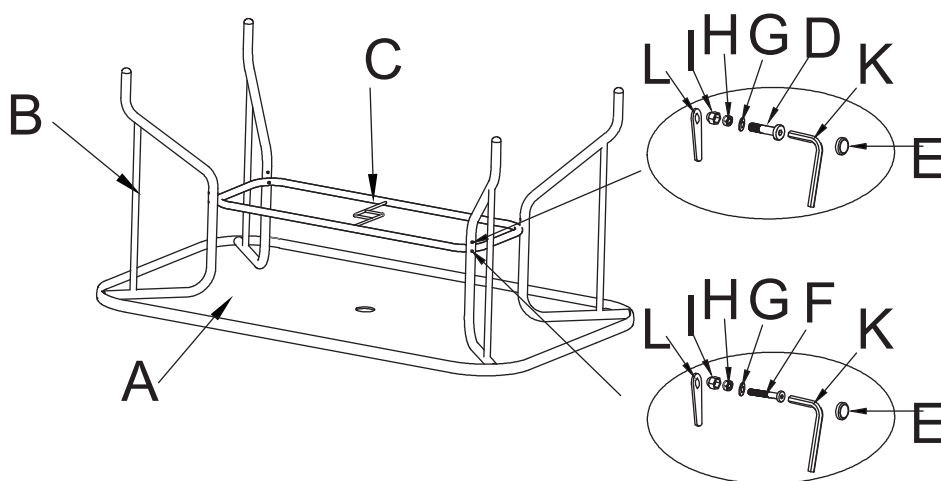

# Amalfi Ivory 140cm x 80cm Glass Table Assembly Instructions

## Step Three

With the help of another person, carefully turn over the table and place it in the upright position. Make sure there is no wobbling when the table is placed on the flat ground.

Your table is now ready for use.

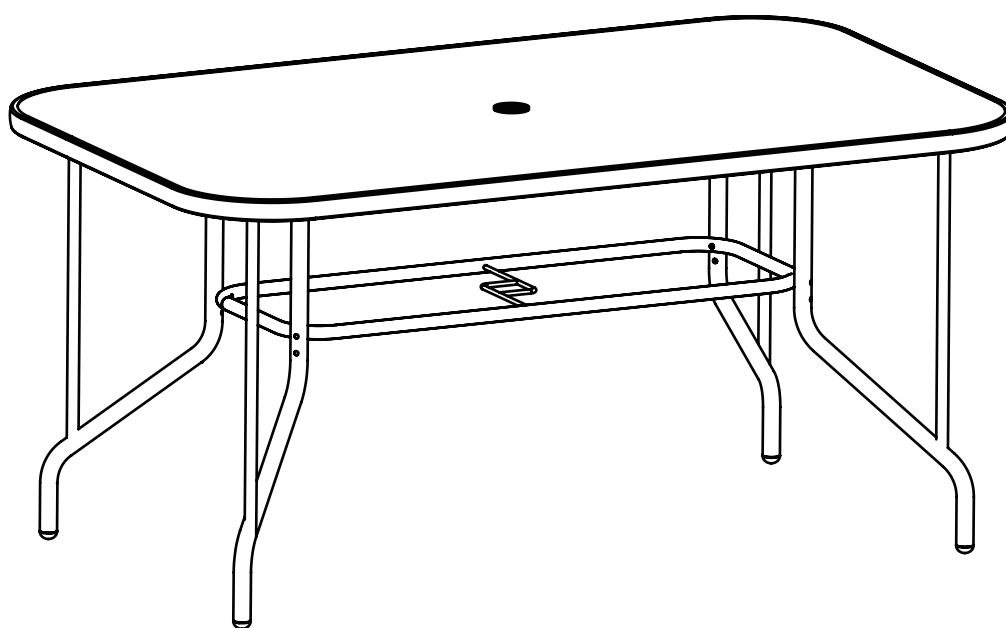

**Note: When using a parasol with this table always use a suitable base weight.**

**PLEASE KEEP THESE INSTRUCTIONS FOR FUTURE REFERENCE**

[www.royalcraft.co.uk](http://www.royalcraft.co.uk)

Product size:  
W56\*D79\*H94cm

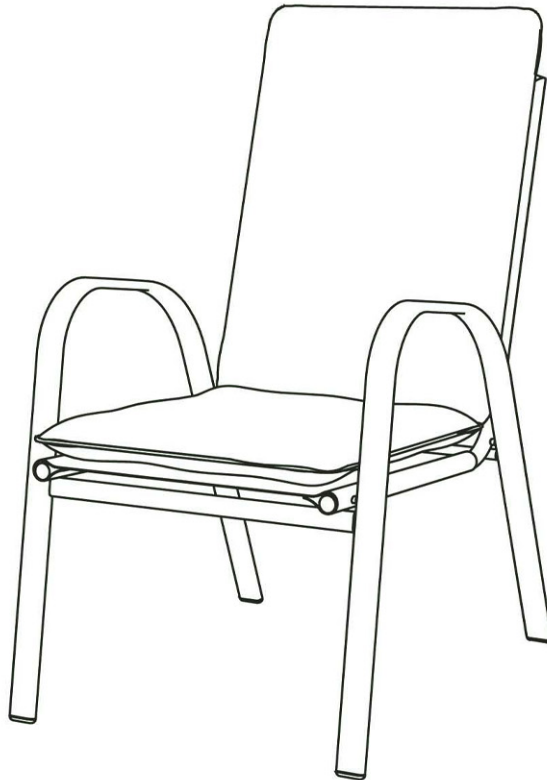

**Furniture should be covered/stored whilst not in use to prolong its longevity.  
(It should also be covered in adverse weather. )**

*The frame of this product is manufactured from mild steel coated with a weather resistant paint. Steel has a natural tendency to rust over time and, whilst we expect you to be able to enjoy your furniture for many years to come, we recommend that you check the product from time to time for signs of paint damage and/ or rust. If the paint should become damaged, or if rust begins to form, you should clean the affected area and apply a suitable “thinners based” touch-up paint. Such paints are readily available from all good hardware and DIY stores.*

The intended use of this product is for domestic use only.

Important, please retain for future reference.

Read carefully.

### Before you start

#### Warnings

##### **IMPORTANT, RETAIN FOR FUTURE REFERENCE READ CAREFULLY**

See enclosed instructions for assembly, safety and care information.

Failure to follow the warnings could result in serious injury.

Handle heavy parts with care.

Ensure that this product is fully assembled as illustrated before use.

This product should only be used on firm, level ground.

##### **Keep small parts out of reach of children.**

This product is intended for **domestic use** only.

Ensure the product is always placed on level ground.

Furniture can be dangerous if incorrectly used. No liability will be accepted for damage or injury caused by incorrect use of this product.

#### Dos

Unwrap all packaging materials and place the components on a suitable surface to prevent scratching your product.

Check all contents are present prior to assembly as per the parts list provided. In the event of problems or missing parts, please contact the seller.

Check all screws and bolts are tightened and inspect regularly.

Make sure the legs remain in contact with the ground.

During severe weather conditions, including high winds, rain, hail, thunderstorms, extreme heat and cold temperatures, the product should be stored inside in a cool, dry place.

To best preserve this product, please use a protective cover when your furniture is not in use. We would also recommend using a gazebo or parasol over your furniture during the summer period and prolonged sunny spells. This will help prevent harmful UV rays from damaging and discolouring the material.

Frames are manufactured using powder coated steel tubing. When steel is exposed to the air and moisture it will rust. Any scratches on the paintwork should be touched up immediately with metal paint to prevent corrosion.

Ensure that the product is clean and dry before storage.

Clean your product with a sponge and warm soapy water then wipe with a clean, dry cloth.

Where instructions as to the; storage, commissioning, installation, use and maintenance of the goods or (if there is none) good trade practice are not followed and a defect arises this will void the 12 month manufacturer's guarantee on the product.

#### Don'ts

Do not use scourers, abrasives, washing powders, chemical cleaners or any other substances containing abrasives since these substances can damage the product.

Do not place very hot or very cold items on the product surface.

Do not strike the product with hard or pointed items.

Do not sit or lean onto the arms of this product.

Do not use power tools to construct this product.

Do not use this product if parts are missing, damaged or worn.

Do not stand or climb onto the product and do not use it as a ladder, as this could lead to it unbalancing and overturning.

Never tilt the chairs during use.

Never drag furniture when moving it, always lift it.

#### **Time to assemble**

No need to assemble

#### **Tools required**

No tools are required

Never tilt the stacking chair during use.

Ensure the product is always placed firmly on the ground.

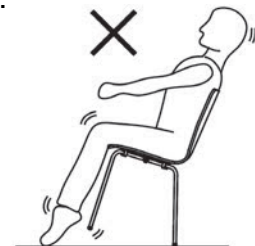

**PLEASE KEEP THESE INSTRUCTIONS FOR FUTURE REFERENCE**

[www.royalcraft.co.uk](http://www.royalcraft.co.uk)

Product Size:  
Dia230\*H220cm



**Furniture should be covered/stored whilst not in use to prolong its longevity.  
(It should also be covered in adverse weather. )**

The intended use of this product is for domestic use only.

Important, please retain for future reference.

Read carefully.



### Before you start

#### Warnings

See enclosed instructions for assembly, safety and care information.

Failure to follow the warnings could result in serious injury.

Handle heavy parts with care.

Ensure that this product is fully assembled as illustrated before use.

This product is intended for **domestic use** only.

This product should only be used on firm, level ground.

**The product contains small parts which could pose a risk to young children. Keep small parts out of reach of children.**

**Keep hands away from folding mechanism and moving parts to prevent possible injury.**

**Never use or open this parasol without a suitable base set in place.**

Furniture can be dangerous if incorrectly used. No liability will be accepted for damage or injury caused by incorrect use of this product.

#### Dos

When you are ready to start, make sure that you have the right tools, plenty of space and a clean, dry area for assembly.

Unwrap all packaging materials and place the components on suitable surface to prevent scratching your product.

Check all contents are present prior to assembly as per the parts list provided. In the event of problems or missing parts, please contact the seller.

Check all screws and bolts are tightened and inspect regularly.

Use a furniture cover to protect your product when not in use.

Ensure your item is closed when not in use.

During severe weather conditions, including high winds, rain, hail, thunderstorms, extreme heat and cold temperatures, the product should be taken down and stored inside in a cool, dry place.

Ensure that the product is clean and dry before storage.

Wipe with a damp sponge and a little warm soapy water, then dry with a clean, dry cloth. The product must be thoroughly dry to prevent mildew and mold stains from forming.

Where instructions as to the; storage, commissioning, installation, use and maintenance of the goods or (if there is none) good trade practice are not followed and a defect arises this will void the 12 month manufacturer's guarantee on the product.

#### Don'ts

Do not stand or climb onto the product.

Do not use power tools to construct this product.

Do not sit or lean on the rims of this product.

Do not use this product if parts are missing, damaged or worn.

Do not leave the parasol open when not in use or unattended.

Do not leave the parasol up or open when there is a risk of high winds, as damage will occur to its structure.

Do not use scourers, abrasives, washing powders, chemical cleaners or any other substances containing abrasives since these substances can damage the product.

Do not use solvent-based cleaners or detergents as they can bleach or damage the product.

Never use a pressure hose or washer to clean the product.

Never drag furniture when moving it, always lift it

Never move this parasol when fully assembled.

To avoid damage do not allow water to collect or "pool" on the fabric.

Do not over crank when opening and closing the parasol to prevent breakage of the mechanism.

#### Number of people required for assembly

One person



#### Time to assemble

5 Minutes



#### Tools required

None

# AMALFI IVORY 2.3M PARASOL

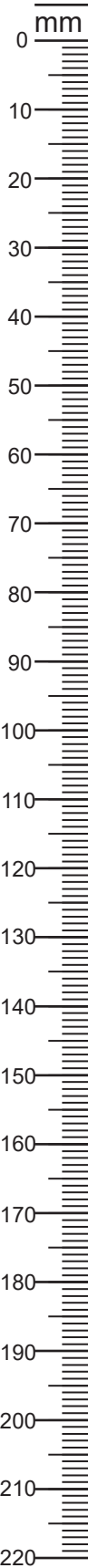
## Assembly Instructions



Parts List					
Part No.	Diagram	Qty.	Part No.	Diagram	Qty.
A		1 PC	B		1 PC
	Main Parasol Part			bottom Pole	

### Assembly and Usage Steps

1. Press the Spring Pin and insert the Bottom Pole (B) into the Main Parasol Part (A);
2. Place the parasol at the intended place for use; Ensure a suitable base (not provided) is used.
3. Rotate the Crank clockwise to spread the parasol canopy;
4. The parasol is closed by reversing above steps.

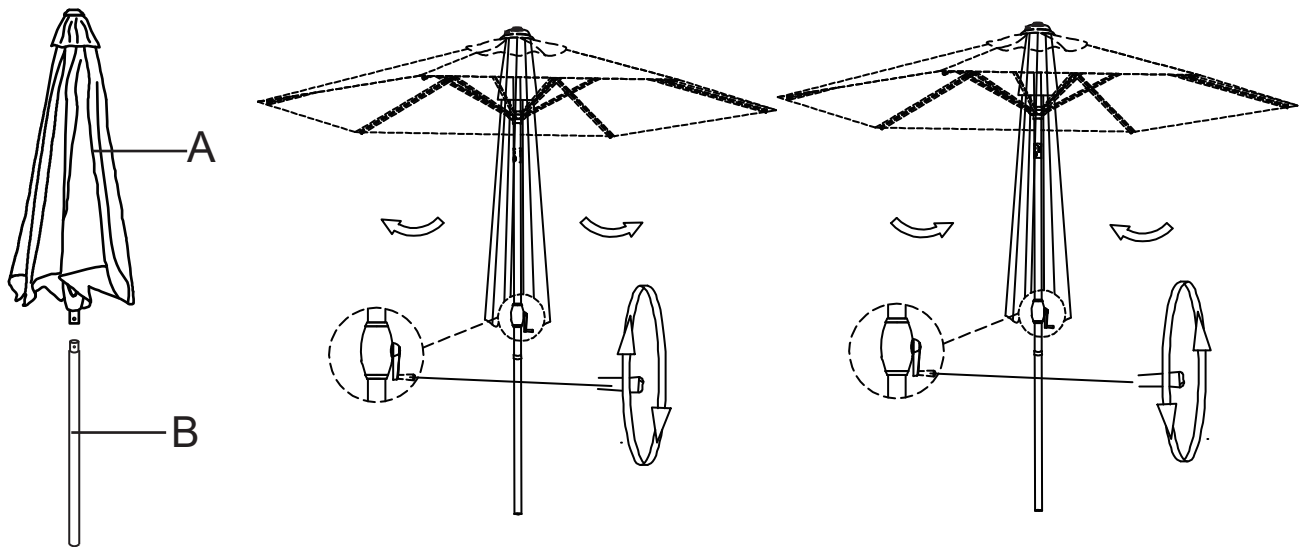

**WARNING**  
Please take care to keep fingers away from moving parts and crank rotating area to prevent possible injury.

**Note: The diagrams are for reference only.**

A suitable parasol based should be used together with this parasol!

**PLEASE KEEP THESE INSTRUCTIONS FOR FUTURE REFERENCE**