







ASSEMBLY INSTRUCTION

SLIM BOOKCASE _ KD

No	LIST OF HARDWARE	FIG	Q.ty (pcs)
①	Bolts M6x30		24
②	Allen key K4		1
③	Round head Screws Ø3.5x15		24
④	Screws Ø4x20		2
⑤	Brackets		2
⑥	Tie		1

Screwdriver (not included) 

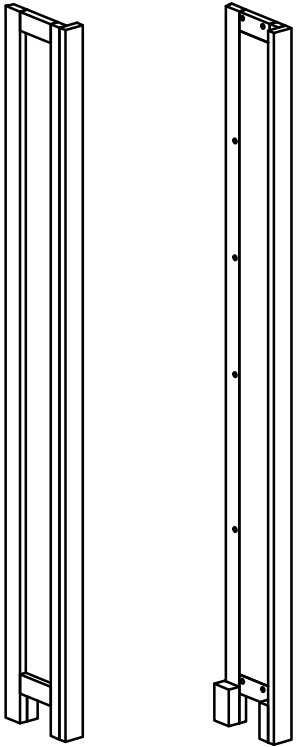
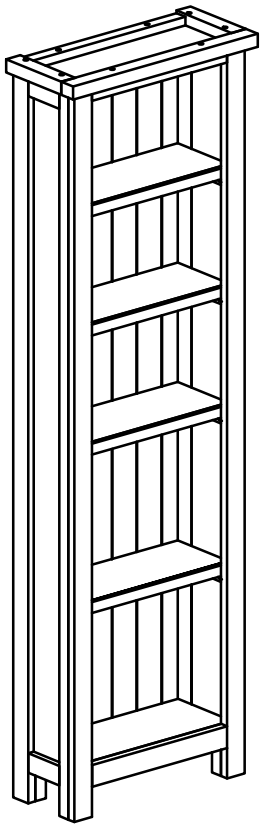

A Side frame (Left - Right): x 2

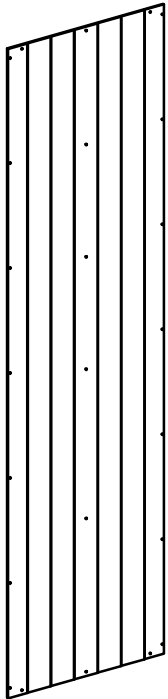

B Back panel: x 1

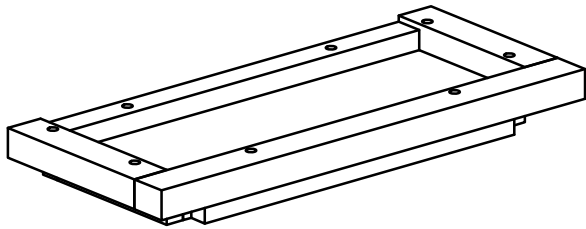

C Top Frame: x 1

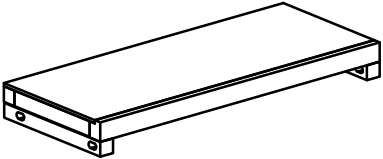

D Shelves: x4

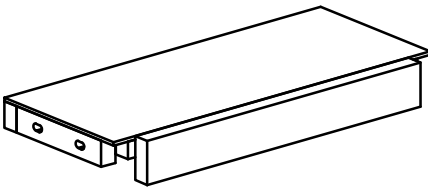

E Bottom Frame: x 1

ASSEMBLY INSTRUCTION SLIM BOOKCASE _ KD

STEP 1

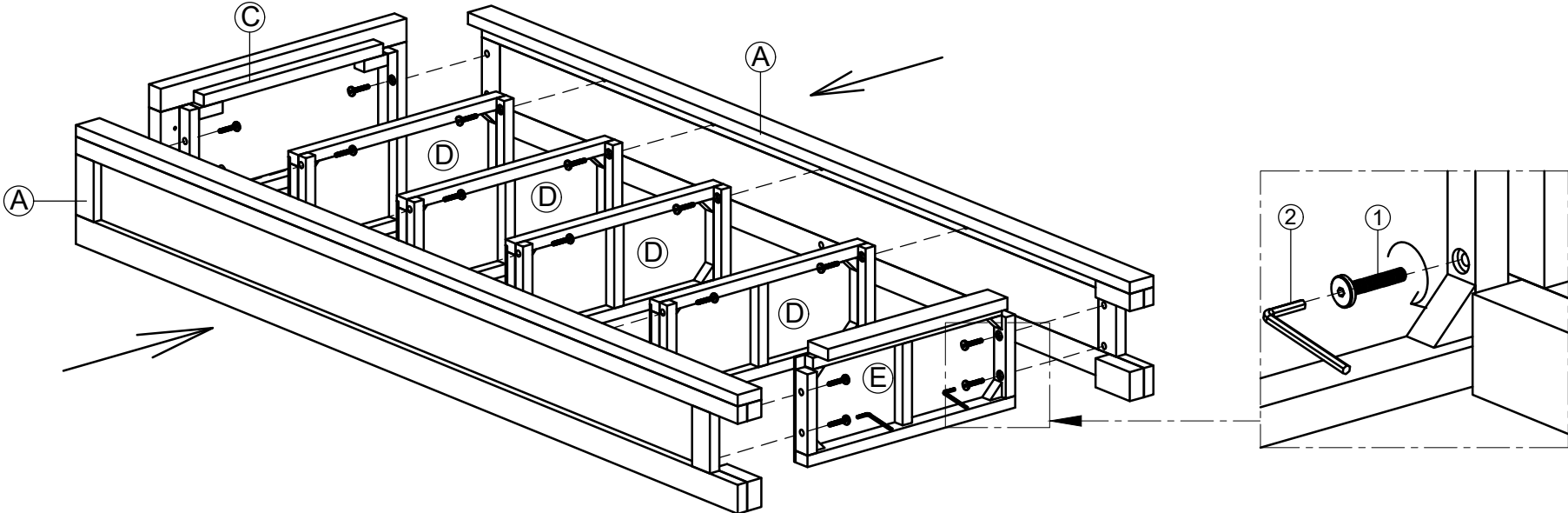

STEP 2

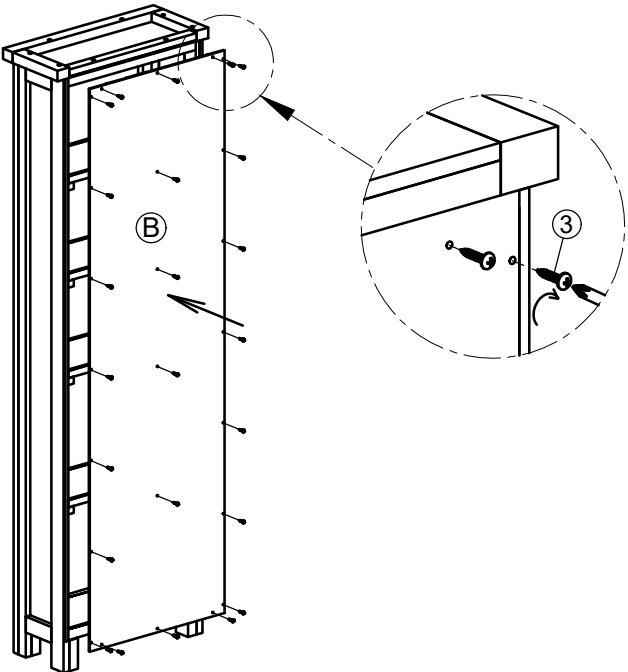

STEP 3

