







# ASSEMBLY INSTRUCTION

## LARGE BOOKCASE \_ KD

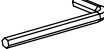
No	LIST OF HARDWARE	FIG	Q.ty (pcs)
①	Bolts M6x35		24
②	Spring Washers		24
③	Flats Washers		24
④	Allen key K4		1
⑤	Round head Screws Ø3.5x15		32
⑥	Screws Ø4x20		2
⑦	Brackets		2
⑧	Ties		1

Screwdriver (not included) 

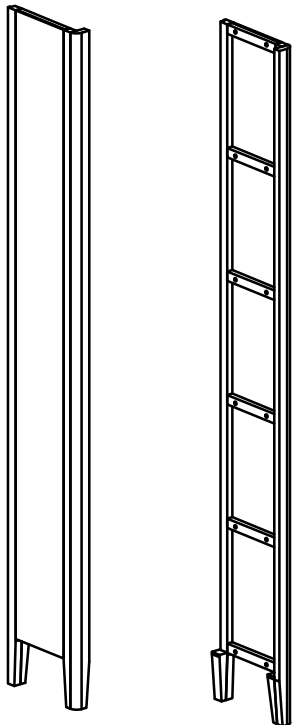
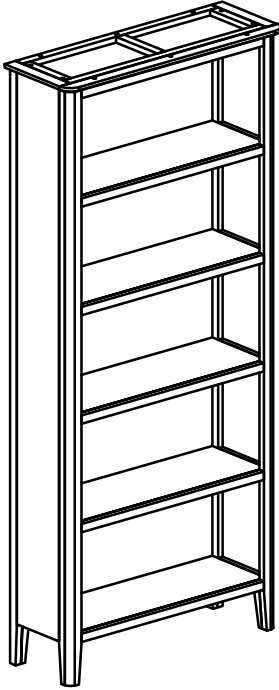

**(A)** Side frame (Left - Right): x 2

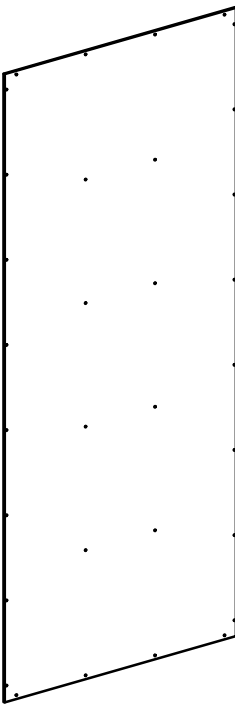

**(B)** Back panel: x 1

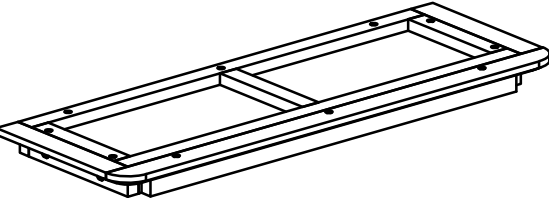

**(C)** Top Frame: x 1

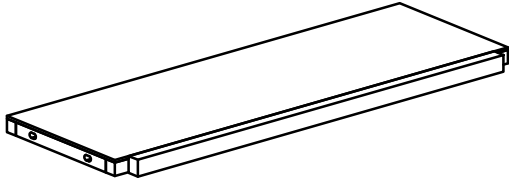

**(D)** Shelves: x 5

# ASSEMBLY INSTRUCTION LARGE BOOKCASE \_ KD

## STEP 1

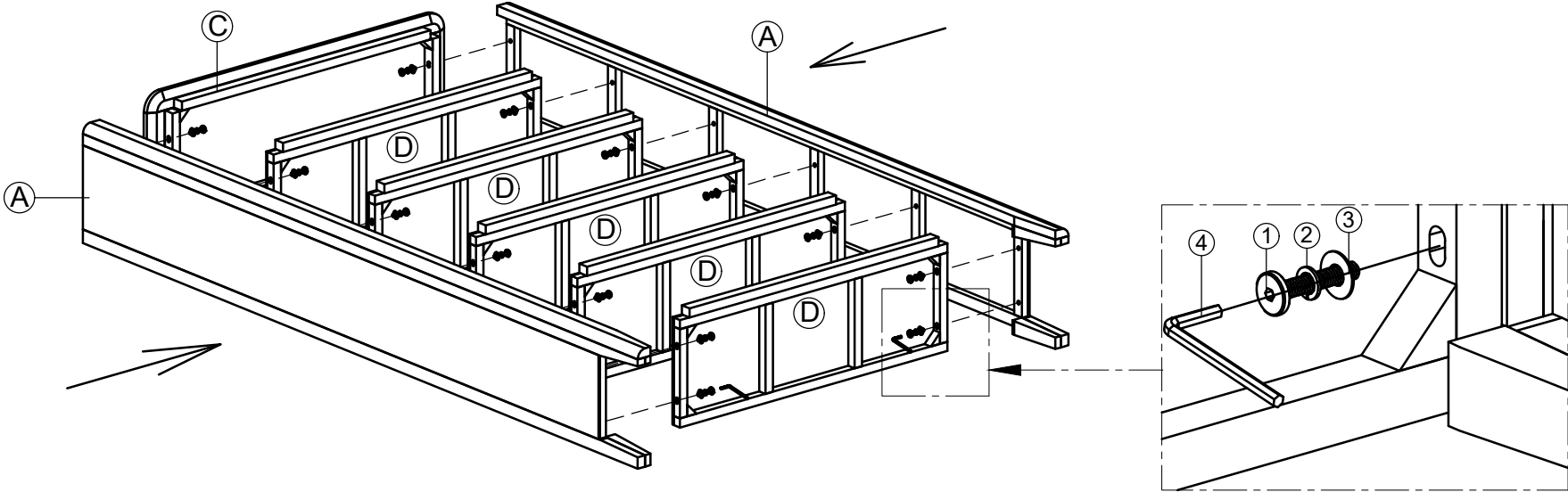

## STEP 2

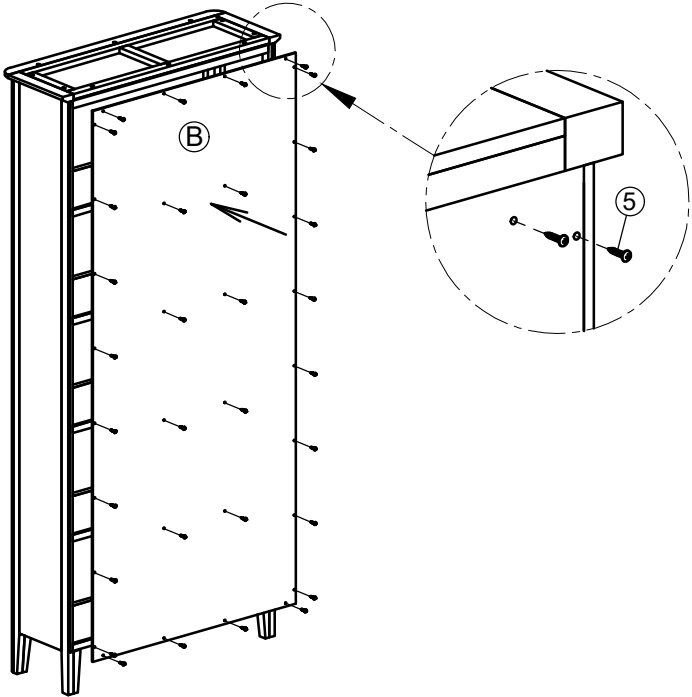

## STEP 3

