

**ALFA**

**USER MANUAL**  
domestic ovens



<b>02</b>	WARNINGS
<b>05</b>	WARRANTY
<b>06</b>	INSTALLATION
<b>08</b>	LPG CONNECTION
<b>10</b>	NATURAL GAS CONNECTION
<b>12</b>	GAS CONVERSION
<b>14</b>	IGNITION - WOOD
<b>16</b>	IGNITION - GAS
<b>20</b>	CARE AND MAINTENANCE
<b>22</b>	CLEANING WOOD-FIRED MODELS
<b>23</b>	CLEANING GAS-FIRED MODELS
<b>24</b>	VENTING GUIDE
<b>26</b>	USING THE OVEN
<b>32</b>	SPECIFICHE TECHICHE
	<i>WOOD-FIRED OVEN:</i>
	<i>32 - NANO</i>
	<i>34 - CIAO</i>
	<i>34 - 5 MINUTI</i>
	<i>36 - 4 PIZZE</i>
	<i>38 - ALLEGRO</i>
	<i>GAS-FIRED OVEN:</i>
	<i>40 - NANO</i>
	<i>42 - BRIO</i>
	<i>42 - STONE OVEN</i>
	<i>44 - DOLCEVITA</i>
<b>46</b>	TROUBLESHOOTING

## GENERAL WARNINGS

RETAIN THIS MANUAL FOR FUTURE REFERENCE  
Additional copies of this manual at [www.alfaforni.com](http://www.alfaforni.com)

WARNING: improper installation, adjustment, alteration, service or maintenance can cause property damage, injury or death.  
Read the installation, operating and maintenance instructions thoroughly before installing or servicing this equipment.

### PLEASE READ THE FOLLOWING INFORMATION FOR PROPER INSTALLATION AND OPTIMUM PERFORMANCE OF THE OVEN.

- The identification plate, with technical data, lot number and brand name is visibly applied on the device. Do not remove this label
- Remove all protective film before putting the unit into operation. To facilitate the separation, use warm air (for example, a hairdryer)
- Never use steel sponges or sharp scrapers, it can damage the surfaces. Use ordinary non-abrasive products. If necessary, use wood or plastic tools. Rinse thoroughly and dry with a soft cloth or microfiber cloth.
- Do not use dishes or containers made of plastic material. The high temperatures inside the oven could melt the plastic, damaging the appliance.
- Use tools and utensils that are resistant to high temperatures.
- Position the oven on a flat and level surface.
- Due to the temperature, the color of the surfaces may vary in time.
- Do not paint or apply objects to the oven.
- Installation of the product must allow for easy access for cleaning.
- Never store, use or put flammable liquids or objects in or near the oven.
- Alfa stainless steel ready-to-use ovens can become hot on the outside even with two layers of high quality insulation
- Always remove the oven door by gripping the handle and using gloves when hot.

- Do not touch the surfaces of the chimney flue during use.
- Keep any electrical wiring and fuel lines away from hot surfaces.
- Do not use the oven if it's not working properly or you suspect a fault in operation.
- Do not move the oven during use or when it is hot.
- Do not lean on or rest objects on the oven, this may compromise its stability.
- Never extinguish the flame with water.
- In the event that a grease fire occurs, turn off the gas and leave the door closed until the fire is extinguished.
- When using the oven wear heat resistant oven gloves.
- The parts that are sealed by the manufacturer should not be modified by the user.
- Do not block the openings and slots provided for ventilation and heat dissipation.
- When using charcoal, only use high quality natural lump wood charcoal. Do not use briquettes, lava rock, liquid fuels, accelerants or anything other than that expressly indicated.
- Do not lift the oven from the sill or shelf
- The measurements of the refractory cooking floor may vary by a few millimeters, this tolerance is due to the craftsmanship of the product.

## **SAFETY WARNINGS**

FOR WOOD-BURNING OVENS ONLY

READ ALL INSTRUCTIONS BEFORE INSTALLING AND USING THIS APPLIANCE

Please read this entire manual before you install the oven.  
Contact your local building or fire officials about restrictions  
and installation inspection in your area.

FOR YOUR SAFETY: Do not store or use gasoline or other flammable vapors or liquids in the vicinity of this or any other appliance. Also, always keep the area under and around this appliance free and clear of any and all combustible materials.

WARNING: Improper installation, adjustment, alteration, service or maintenance can cause property damage, injury or death.

## **SAFETY WARNINGS**

FOR GAS-BURNING OVENS ONLY

GAS LEAKS MAY RESULT IN FIRE OR EXPLOSION AND CAUSE SERIOUS PERSONAL INJURY OR DEATH, OR PROPERTY DAMAGE.

IF YOU SMELL GAS:

1. Turn the gas off.
2. Put out any live fire or flames.
3. Open the door to the oven.
4. Consult a licensed gas professional

ATTENTION! The gas oven may be converted from LPG to natural gas and viceversa using the Alfa Ovens supplied conversion kit. Follow the supplied instructions or contact a qualified and licensed gas professional.

WARNING: If the gas oven is not used  
close the gas supply valve.

WARNING: Do not store unused gas cylinders near the oven.

## **WARRANTY**

In compliance with Italian and European regulations, ALFA ovens are covered by the legal guarantee, paid by the retailer, of 24 months from the date of purchase.

After the warranty period of 24 months, any repairs will be borne by the consumer.

**YOU ARE REQUIRED TO KEEP THE RECEIPT OR PURCHASE INVOICE TO SHOW THE DEALER. WRITE BELOW THE SERIAL NUMBER INDICATED ON THE DATA PLATE.**

ALFA also provides remote technical service by call from Monday to Friday from 8:00 to 17:00 (Italian Time).

Good maintenance and correct use can help extend the shelf life of the product.

We suggest that you store the oven indoors during winter to protect it from adverse conditions or that you put a breathable cover on it.

The warranty DOESN'T apply in the following cases:

- If the oven is not properly used or installed as described in the instruction manual.
- If the oven has been intentionally or unintentionally damaged.
- If the oven is not or is inadequately maintained. Burner problems due to food residues or to the use of different fuels are not covered by this warranty.
- If the oven has been altered in any manner and is no longer in the condition it was upon delivery.
- If the recommended fuel has NOT been used. Never use liquid charcoal for barbecue, chemicals or any other fuel.
- If the damage is due to the use of chemicals inside or outside the oven.
- This warranty does not cover the oven door.
- Damages due to exceeding the temperature limits of 450 °C/850 °F.
- If you use parts not manufactured or recommended by Alfa.
- If the damage is done to parts that are decorative or not functional that do not affect the normal use of the oven, including scratches or colour changes.
- If the data plate has been removed, altered or erased.
- Our firebricks are not covered by the warranty; however, our ovens include a spare one and further components can be purchased on demand.



## INSTALLATION

### ATTENTION

the outer sides of the oven can reach temperatures above 50°C (120°F). Any flammable materials must not be within 1-metre radius of the oven.

**CAUTION:** When being used, place the oven at a safe minimum distance from flammable materials or any other substance that can be damaged by heat.

### CAUTION

**Put the oven away from wind or strong draughts.**

### FOR YOUR SAFETY

**Place the oven on a flat and stable surface. Involuntary movements during operation may result in personal injury and property damage.**

**CAUTION:** Place the oven at a minimum distance of 20 cm (8 in) from the wall or any other equipment. Increase the minimum distance to 50 cm around the flue and 1m from the top of the oven.

**THE TOP VERSION OVENS SHOULD BE PLACED ON TABLES OR OTHER FIREPROOF SURFACES WITH ENOUGH LOAD-BEARING CAPACITY** (for the weight, refer to the product data sheet attached to the instruction manual), **ADJUST THE LEVELLING FEET TO HOLD THE OVEN STEADY.**

To move the oven more easily, remove the bricks inside the combustion chamber

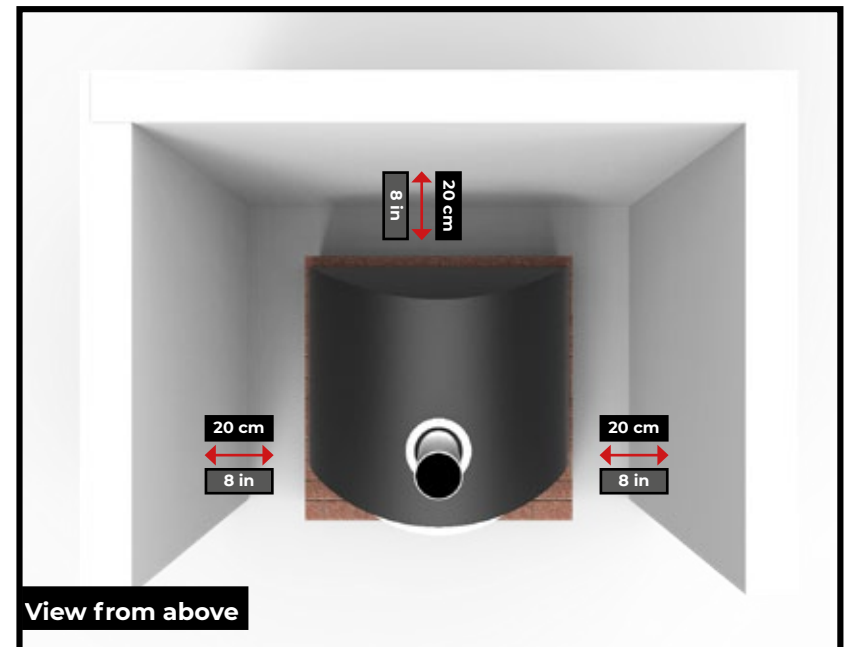
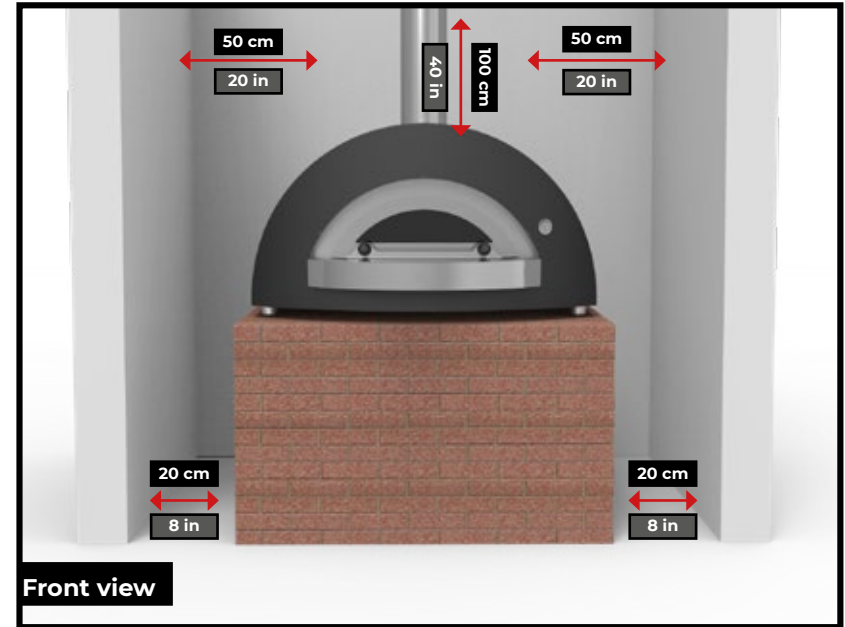

## CONNECTION

ONLY FOR LPG OVENS

### CONNECT THE LPG BOTTLE

Connect the flexible hose to the back of the oven.

#### PRESSURE REGULATOR

(not included):

- Gas flow: 10 Kg/h
- Outlet pressure:
  1. Gas G 30 28-30 mbar
  2. Gas G 31 30-37 mbar

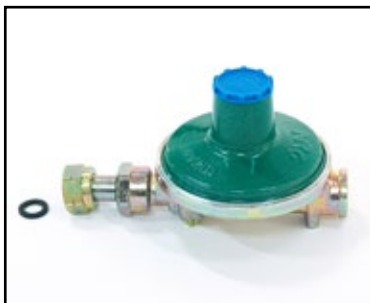

#### FLEXIBLE HOSE (not included):

- Diameter 1/2"
- Length 1,5 m

#### BOTTLE

- We recommend a bottle between 10 and 30 kg.

#### WARNING: Follow the advice for a proper use of a gas bottle.

- Use a standard G30/G31 pressure regulator (not included) and a DN 12 mm CE EN 14 800 hose.
- LPG is heavier than air so any gas loss may collect in low spots.
- The LPG bottle must always be installed, transported and stored in a vertical position: Handle with care and do not drop the bottle.
- Make sure that the gas bottle is placed in a ventilated room away from other objects.
- Never store a spare gas bottle near the oven.
- Do not leave or transport the LPG bottles to places where temperatures can reach 50°C (120°F) because they can get too hot to handle. (For example: never leave the gas bottle in the car on a hot day).
- Treat empty gas bottles as carefully as full ones. Even if there is no more liquid in the bottle, there is maybe some gas left. Always turn off the valve before disconnecting the bottle.
- Make sure that the LPG bottle or the regulator valve is shut off. Change the gas bottle away from heat source and with the oven off.
- Replace the gas pipe periodically, respecting the indicated deadline.
- Only use LPG bottles.
- Never twist the gas hose.
- Before using the oven, check that the hose does not have any marks, cracks, abrasions or cuts. If it is damaged, do not use the oven.
- Always check the gas connections before using the oven.



**1.** Insulate the oven gas connection with Teflon tape (A) and screw in the gas hose.



**2.** Screw the gas regulator into the bottle valve and turn the bolt counterclockwise. Use the gas bottle spanner to tighten and not to damage the gasket and the watertight seal.



**3.** Connect the flexible hose to the pressure regulator.



**4.** Screw the hose to the oven with the help of the right spanner to securely fasten it.

**5.** Apply some soapy water to the entire assembly. Turn on the valve without igniting the appliance; if there are no bubbles then you can proceed with the ignition. If a leak is detected, replace the part immediately.

**6.** Turn the bottle so that the valve opening faces the rear of the oven.



### WATCH THE VIDEO TUTORIAL

Scan the qr-code or type [alfaformi.com/kit-gas.php](http://alfaformi.com/kit-gas.php)

## CONNECTION

ONLY FOR NATURAL GAS OVENS

### CONNECT TO THE GAS NETWORK

- The natural gas supply must be made with  $\varnothing$  1/2" **galvanized pipe (A)** or **copper pipe (B)** to fit into the burner inlet hole. Alternatively, use a **(C) flexible connection pipe** between the oven and the wall power supply.
- Install the **gas tap (D)**
- Connect the hose to the back of the oven.

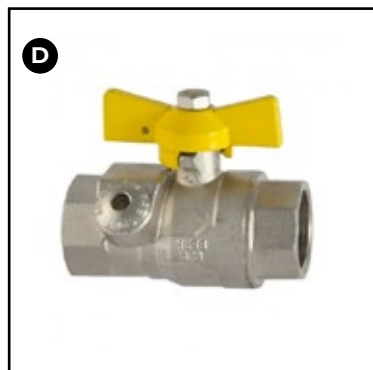

### WARNING: Follow the advice for a proper use of the oven.

- Check all the gas connections before using the oven.
- Make sure the gas tap is turned off when the oven is not being used and during maintenance or cleaning.
- Replace the gas hose every 2/3 years.
- Never twist the gas hose.
- Before using the oven, check that the hose does not have any marks, cracks, abrasions or cuts. If it is damaged, do not use the oven.



**1.** Insulate the oven gas connection with Teflon tape (A) and screw in the gas hose.



**2.** We recommend installing a gas-tap between the wall power supply and the connection pipe to the oven



**3.** Connect the hose to the wall power supply



**4.** Screw the hose to the oven with the help of the right spanner to securely fasten it.

## CONVERSION LPG-NATURAL GAS

ONLY FOR GAS OVENS

**ONLY USE THE COMPONENTS  
AND PARTS SUPPLIED BY ALFA FORNI.**

**WARNING:** The conversion must be performed by qualified technicians when the oven has completely cooled down. Improper installation, adjustment or maintenance can cause property damage or personal injury.

**The oven is supplied with LPG or natural gas.  
Follow the instruction for the conversion.  
The LPG bottle is not included.**

### 1 BURNER DISASSEMBLY

Remove the gas kit following the instructions contained in the manual.

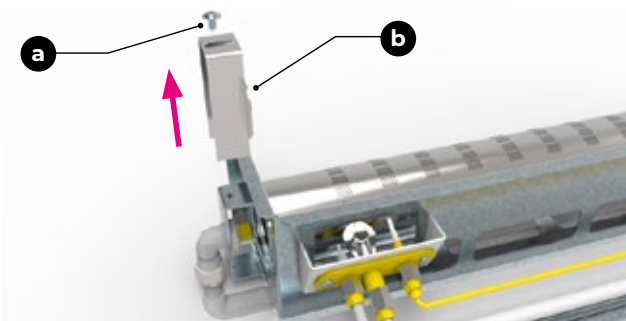

### 2 REPLACEMENT OF THE MAIN NOZZLE

Unscrew the fixing screw (a) and remove the plate (b). Unfasten the main nozzle (e) from the holder (d) by using a 11 mm spanner. Replace the nozzle and screw it back to the holder (d) without tightening too much. During these operations, lock the nozzle holder (d) to keep it from rotating.

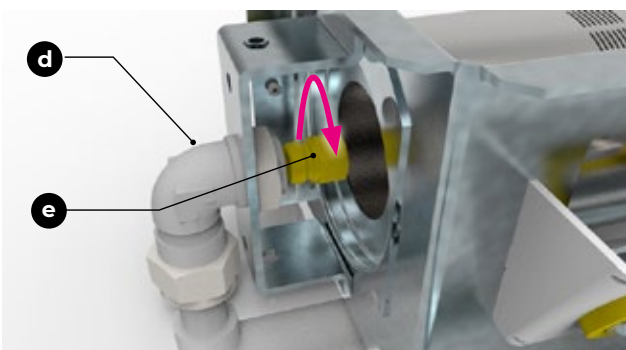

### 3.1 REPLACEMENT OF THE PILOT NOZZLE (only in case of maintenance)

Unscrew the fixing screw (h) from the pilot light pipe.

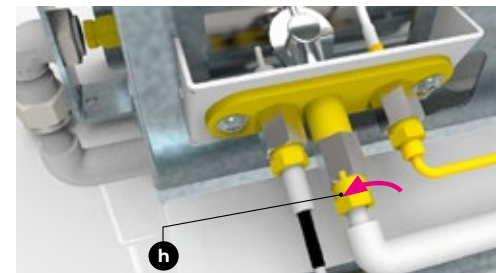

### 3.2

Remove the pipe (i).

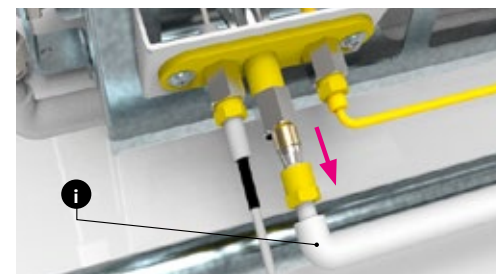

### 3.3

Remove the pilot nozzle (j) from the cone-like support (o) and replace with the spare part included in the kit. Reassemble it proceeding in reverse order.

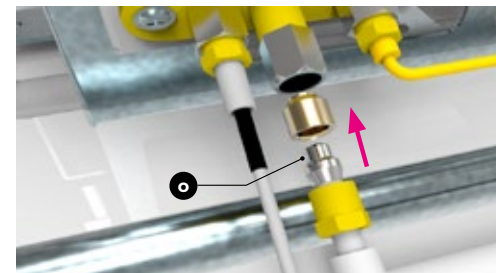

**At the end of this operation, apply the new label on the product and make sure that the nozzle diameter corresponds to what is specified on the label.**



## LIGHTING THE OVEN

ONLY FOR WOOD VERSION

**WARNING: Follow the instructions before turning on the oven.**

- Do not use flammable liquids or other fuels to light the oven.
- Make sure that there are no flammable materials near the oven and that the minimum safety distance is respected.

**1 - In the center of the oven or slightly right of center create a cross stacked pile of ALFA Wood using smaller pieces.** Include 2-3 QwikWik brand or your favorite fire-starters to help start the fire quickly.

**2 - Light the QwikWik firestarters to ignite your initial cross stacked wood pile in the oven**

**3 - After the wood is on fire, replace the oven door on the oven warming shelf leaving a small gap of 1-2 inches (3-5 cm) so air can enter the oven and to help keep the fire roaring.** This helps keep the fire in the oven and heat the oven to your desired temperature faster.

**4 - Slowly add larger wood logs to create a larger fire.** Do this for about 15-20 minutes depending on the size of your oven. Larger ovens can take longer to heat up. Do not put too much wood in at one time and replace the door as noted in section 3 to help keep the flame inside the oven.

**5 - After you've built a nice fire and hot bed of coals move them to the left side of the oven with the help of the ember mover.** The fire should be on the opposite side of the thermometer for the most accurate oven chamber temp.

**6 - Clean the refractory floor with the brush tool.**

**7 - Use an infrared thermometer (not included) to gauge the oven floor temperature**

**8 - When the oven floor is the right temperature you're ready to begin cooking your pizzas!** Cook pizzas with the oven door off and feel free to replace the oven door with the same gap for air as mentioned in section 3 to keep heat and flame in the oven.



## TURNING OFF

- To turn the oven off, close the oven door and wait for ash to form.
- When the fire is out and the oven has been completely shut down for 60 minutes or longer and you confirm the coals have cooled down, you can remove the ashes into a fire safe metal ash can.
- Never put hot coals or ashes on the ground, patio, deck or near plants or trees.

## DIFFERENT TYPES OF WOOD

- Use small sized wood pieces that are very dry for lighting.
- Treated wood, pine, resin or scrap woods are strictly prohibited.
- Wet or damp wood can be difficult to start and can pop due to the increased volume of water. This will produce a lot of smoke and ash and less than optimal heat and performance.

### FOR YOUR SAFETY:

- Do not exceed the temperature limit of 500°C (1 000°F).
- Do not leave the oven unattended when the fire is going.
- To keep constant temp, throw in small quantities of firewood at regular intervals; do not keep adding more logs to avoid a dangerous rise in temperature or flames spilling out of the oven that might damage people or property.

### ATTENTION

**Follow the specific instructions for each model,  
in this manual from page 34 to page 41**

## IGNITION

FOR GAS-FIRED OVENS ONLY

### WARNING: Before firing up the oven, follow the instructions.

- Check all gas connections before using the oven.
- Do not lean over the oven when lighting it.
- Keep your face and your body at least 50 cm away from the oven door. There must be no door, when lighting the oven.
- The gas knob must be in the "0" position.

1. To ignite the pilot light, press and turn the knob to the spark symbol.

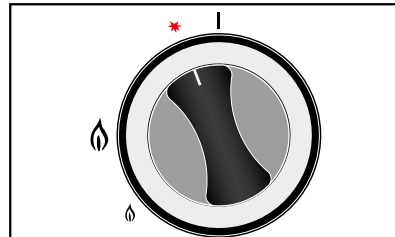

2. Press the gas knob and the ignition button at the same time to spark the pilot light.  
N.B. The ignition of the pilot light might need several attempts due to the air in the supply line, so be patient.

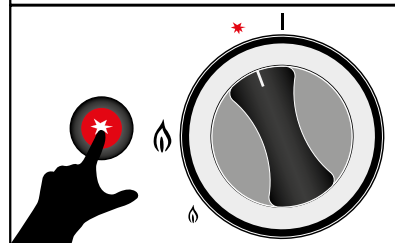

3. Once the pilot light is on, release the ignition button but **KEEP PRESSING** the burner knob for about 15 seconds to allow the thermocouple to heat up enough.

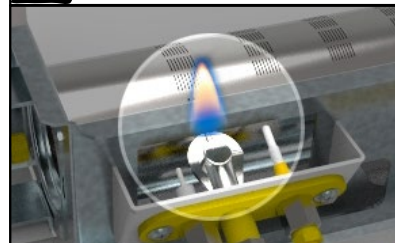

4. Release the gas knob and turn it counter-clockwise to high flame setting to heat up the oven.

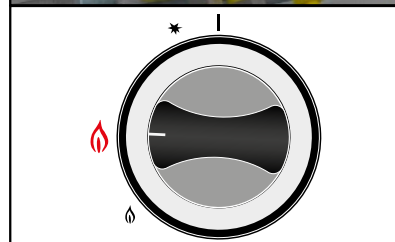

## OTHER COMMANDS

- To extinguish the flame of the main burner and leave only the pilot light on, turn the knob to the star.
- To switch off the main burner and the pilot light, turn the knob to the "0" position.
- If the flame does not light, release the knob and turn it back to the "0" position, wait for about 3 minutes and repeat the procedure. If it takes several tries to ignite, keep the knob pressed in the ignition position (Fig. 1) for a few minutes in order to drain the gas inside the pipe.

### FOR YOUR SAFETY:

- **Do not exceed the limit temperature of 450°C (840°F).**
- **Do not leave the oven unattended when the fire is going.**
- **Never run the oven full throttle for too long.**
- **Never disconnect the gas pipe or other fittings when the oven is in operation.**
- **Do not touch the external surfaces and the flue during use because they can get too hot.**
- **In case of naked flames, contact Alfa technical support.**

### ATTENTION

Follow the specific instructions for each model,  
in this manual from page 42 to page 49

## ELECTRONIC BUTTON

ONLY FOR GAS OVENS

The ignition button comes with AA battery included. To install it, follow this procedure.

1. Unscrew the button head.
2. Put in the battery.
3. Screw the button head.

Carry out these operations when the oven is off.  
Remove the battery during long periods of inactivity.



## CARE AND MAINTENANCE

CALENDARIO MANUTENZIONE		
	CLEANING	TIME SCHEDULE
1	Combustion chamber	Every use
2	Cooking floor	Every use
3	Oven outside	Weekly
4	Stainless-steel parts	Weekly
5	Steel protection	Monthly
6	Burner	Monthly
7	Nozzles	Yearly
8	Rust spots	Biennially

### Clean the combustion chamber.

Pyrolysis 500°C (1 000°F). The Alfa ovens clean themselves thanks to a process called pyrolysis (pyro "fire" + lysis "separating"). It is a procedure that uses very high heat to decompose organic materials and to transform them into volatile compounds. To activate pyrolysis we suggest you keep the temperature at 500°C (1 000°F) for 2-3 minutes.

**1. Clean the cooking floor.** Once the pyrolysis is finished, wait for the oven to cool down and remove any food residues with the help of a brush and a damp cloth. You should clean your oven floor after each use.

**2. Clean the oven outside.** Like all 304 stainless and powder-coat products, Alfa ovens are built to withstand adverse weather conditions including salt air corrosion as long as punctual and effective maintenance is ensured. To clean stainless steel, use a soft cloth soaked in a solution of water and soap or alternatively with baking soda and dish detergent. Rub gently when the oven is completely cold. **IMPORTANT:** always check the certification of the product you use and that the components are those declared.

**ATTENTION:** Steels subjected to high temperatures and direct flames tend to change color on the surface.

This is an inherent feature of the material.



### 3. Clean the stainless-steel parts

ALFA ovens are made with 304 stainless-steel outside and 253 stainless-steel inside. To clean these parts, we recommend that you use a stainless-steel cleaner. Please carefully read the warnings and the instructions. Do not use detergents containing acids, white spirit or xylene. Rinse well after cleaning the oven.



### 4. Protect stainless steel.

To better protect the stainless-steel parts, we suggest using Vaseline or olive oil or baby oil as substitutes. In the case of beach front installations, to avoid salty air corrosion and white thin layers, often clean the oven with fresh water.



### 5. Gas burner

The gas burner must be cleaned from time to time by removing food residues with the help of a brush. When cleaning valves and burners, be careful not to damage the burner and not to enlarge the holes.

**6. Clean the nozzles** at least once a year to prevent them from clogging thus reducing the gas flow (contact qualified persons).

**7. Remove rust spots.** Stainless steel is rust-proof but in some cases (humidity, salty air, sea spray...) some rust stains might appear. Use a rust remover to make your oven shiny and new once again.



## COVER THE OVEN

- Do not forget to use the Alfa cover to protect your oven.
- Visit our dedicated page to find out some advice on how to maintain the ovens, to clean them and to extend their lifespan.



## CARE AND MAINTENANCE

### SPECIFICATIONS FOR WOOD-FIRED OVENS

- Before lighting the oven make sure that **the chimney flue is unobstructed** and that any previous ash has been removed.
- When the fire is out and the oven is cold, collect the ash from previous cooking with a wire brush and a shovel.
- The oven can be used all year round; in the winter months, heat the oven with a small fire to avoid thermal shock due to humidity.
- **Creosote** - Formation and need for removal. When the wood is burned slowly, it produces organic vapors which combine with moisture to form creosote. Creosote vapors condense in the flue and accumulate on the inner surface of the flue.
- The chimney should be **inspected** at least twice a year for creosote build-up. When you observe excessive creosote, it should be removed to reduce the risk of fire.
- **Remove and sweep the chimney flue** once a year: birds nesting in it or other obstructions can lead to hazardous blockages.

## CARE AND MAINTENANCE

### SPECIFICATIONS FOR GAS-FIRED OVENS

#### 1. MAINTENANCE.

The gas burner should be cleaned periodically by carefully sucking up any food residue. When cleaning valves and burners, be careful not to damage the burner. Do not enlarge the burner holes (The openings where the gas escapes).

#### 2. GAS BURNER DISASSEMBLY

- Before cleaning the gas burner, remove it from the oven by proceeding as follows:
- Remove the front knob **(A)**.
  - Unscrew the fixing screw **(B)**.
  - Unscrew the fixing screws and remove the protection casing **(C)**.
  - Remove the gas box **(D)** to expose the connection of the piezoelectric ignition cables **(E)**.
  - Disconnect the two piezoelectric ignition cables. If need be, remove the protection casing by unscrewing the screw **(F)** and pull the burner out.
  - Clean the burner.
  - To assemble the burner, repeat the procedure in reverse order.

#### 3. OVEN STORAGE

- If the gas-fired oven is not used, shut off the supply valve of the gas bottle.
- If the gas-fired oven is stored in a closed space, disconnect the gas supply. The bottle must be left outside in a well-ventilated area.
- In the event that the gas bottle is not taken out of the oven, place the whole lot in a well-ventilated area.
- The gas bottles must be stored outdoors in a well-ventilated area and out of reach of any children. Unused bottles shouldn't be stored in a building, garage or other enclosed space.



## VENTING GUIDE

### FOR WOOD FIRED AND GAS OVENS

#### IN THE GARDEN

When installing the ALFA Oven in your outdoor cooking area with the venting away from any structures or low ceilings, the ALFA supplied high quality stainless steel pipe and cap are sufficient.

**WARNING:** Major causes of vent related fires is failure to maintain required clearances (air spaces) to combustible materials.

**Note:** The outer walls of oven may reach high temperatures, more than 50°C (125°F). Position the oven so it is not in contact with the wall or other furniture and make sure there is a gap of at least 8 inches (20cm).



#### ON THE TERRACE OR UNDER A PERGOLA

For indoor ALFA oven venting installations, or outdoor settings where your wood fired oven will be under a roof structures, pergolas, or terrace.

If you are penetrating through an object overhead, you must remove the single-walled pipe provided and start with the pipes and chimneys manufactured by specialized companies.

If a bend is needed to change the pipe or chimney direction to avoid an obstruction, you can use up to (2) 30-degree or less angles but NEVER together to form a 60-degree bend.



#### OFFSET ELBOW INSTALLATION:

- Avoid elbows if at all possible, as a vertical pipe or chimney is the most efficient
- Pipe or chimney systems may have a maximum of 2 offsets (two elbows total) of 30-degrees from vertical

**DO NOT CONNECT THIS TO A CHIMNEY FLUE SERVING ANOTHER APPLIANCE**

## LIGHTING THE OVEN

### - 1.1 For Neapolitan pizza

Pizza needs both flame and very hot sustained temperature (floor and dome). Use small dry pieces of wood to start your fire and control your flame and temperature:



### - 1.2 For grilling

Grilling uses more embers to get the smoke flavor in the oven and less flame to prevent burning. Larger pieces of wood or lump charcoal (not briquettes) can help control temps.

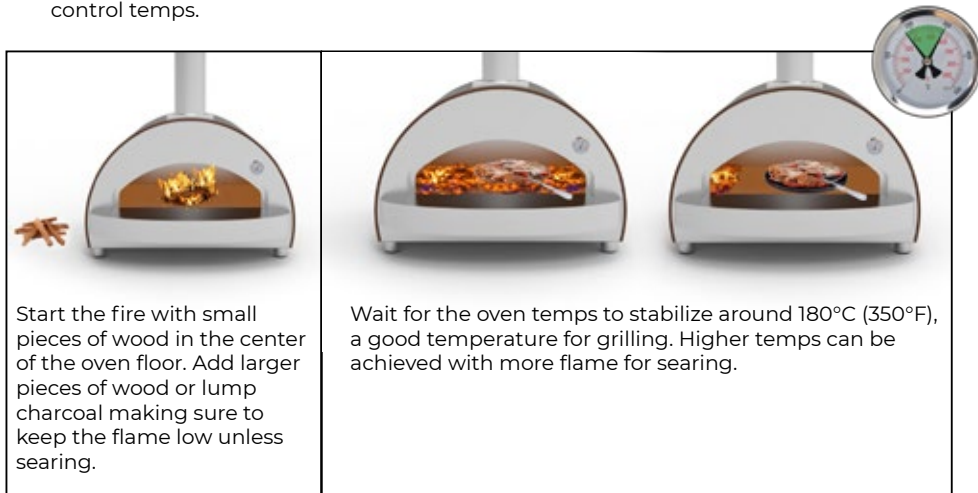

### 1.3 For baking / tray

The stainless steel ovens are made to light up and increase temperature in a short time and hold temps for extended periods of time.

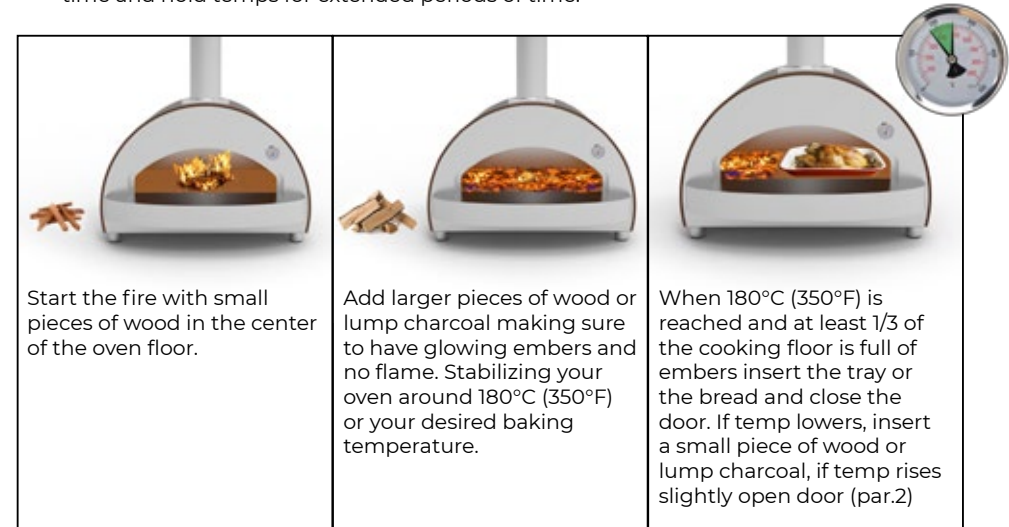

### - 2.1 Manage the smoke

Smoke can be desired for traditional barbeque but also can be too much for certain foods and for the people that you are entertaining – both taste wise and vision/smell wise

1. Use dry wood (wet wood doesn't burn well and makes smoke)
2. Try to keep the flame always on
3. If you have embers (no flame) insert a small piece of paper or starters and then put a small piece of wood, paying attention to let the air enter among embers and wood
4. To avoid the smoke do not use the door - more air enters, less smoke you'll have
5. Place the oven strategically so smoke is manipulated to flow away from your entertaining area – the wind can affect smoke as well especially on an abnormally breezy day

### - 2.2 Looking for the smoke



For the people who want to cook with smoke we suggest to:

1. Try to close the door when the flame is on
2. Use big pieces of wood or lump charcoal
3. If the flame is high break the flame to produce embers (and then use the door or big pieces of wood)

## USE THE DOOR AND SMALL PIECES OF WOOD TO STABILIZE



### - 3.1 Stabilize the temperature

The wood fired oven is designed to let the user choose the right temperature depending on what they are cooking. Stabilizing the temperature is the biggest challenge for the user but with experience it becomes much easier. There are 3 elements designed to assist in Temperature stabilization:

 <p>The Door (use the door to control the internal temperature, open more to cool down and close more to raise it up). Completely Close to smother the fire for many minutes.</p>	 <p>The Fuel: once temperature is consistent and stable, add small pieces of lump coal or wood chunks to maintain the desired temperature and to avoid either temperatures that are too low or creating sudden jolts of high temperatures or flames)</p>	 <p>Rotation -Control and check distance of food from the flame and embers to prevent burning your meal (closest to flame/embers is the highest temperature) Rotation is a key technique</p>
--	---	---



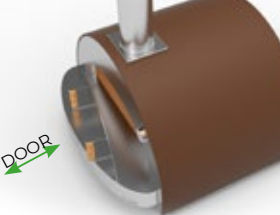

### - 3.2 Cool down the oven

The wood fired oven is a machine that can easily reach temps over 500°C (1000°F) but with no possibility to switch off (never use the water as it can cause the oven floor fire bricks to be damaged). We suggest doing these 3 actions:

 <p>Open the door. The longer the door is opened, the faster the oven cools down.</p>	 <p>Use the pizza turner or wood rake to break the fire and wood.</p>	 <p>Spread the embers over the cooking floor.</p>
--	--	--

### - 3.3 Raise the temperature up

The wood fired oven is a machine that can also raise the temperature quickly, with stainless steel dome oven, it's simply and easy to do.

 <p>FROM 150°C (300°F) TO 250°C (480°F) Insert 1 small piece of wood and close the door partially on the opposite side of the flame</p>	 <p>FROM 200°C (400°F) TO 300°C (570°F) Insert 2-3 small pieces of wood.</p>
 <p>FROM 200°C (400°F) TO 400°C (750°F) Insert 3-5 small pieces of wood, always keep the door closed.</p>	 <p>RAISE 50°C (100°F) Keep closed the door and check the temperature</p>



## FLAME INTENSITY, COOKING FLOOR AND TEMPERATURE



### - 4.1 Flame and cooking floor for Neapolitan pizza

The flame for the Neapolitan Pizza has to be strong. Use laser thermometer to measure the temperature of the oven floor. The ambient and oven floor temps should both be about 380-400°C (700-750°F). The flame must be very lively.



### - 4.2 Flame for roman and focaccia pizza

The focaccia (also called roman pizza) needs lower temperature than the Neapolitan pizza. Reaching this temperature is easy: you need a lively flame.



### - 4.3 Deep Dish Pizza/Detroit Style Pizza

Pizza in a tray/pan is made for more toppings and a thicker pan crust. Cast Iron, stainless steel or mixed-use heavy trays are recommended. The difficulty in cooking this kind of pizza is to cook the bottom of the pizza: we suggest covering the pizza with an aluminum foil with flame. After 10 minutes, check the bottom of pizza: if it is almost brown, you can remove the aluminum paper and leave the pizza to be cooked on top.



### - 4.4 Big bread

If you want to cook a larger loaf of bread (at least 4 pizza dough, 1 Kg) you want to have lot of embers. With temperature approximately 200°C (400°F) and the cooking floor is around 200°C (400°F) you can insert the bread dough. We suggest closing the door and checking the temperature every 5-10 minutes. The oven should cool down to 160°C (325°F) in one hour and the bread should be ready (do not cut it till it's cold).

**Find out the new Forni Alfa blog dedicated to the world of pizza, fine food and, most of all, good cooking.**

[www.alfaforni.com/en/blog-en/](http://www.alfaforni.com/en/blog-en/)



**Want something fancy?**

Here are many recipes and tips for grilling and cooking with the ALFA oven.

[www.alfaforni.com/en/blog-en/recipes/](http://www.alfaforni.com/en/blog-en/recipes/)



**How valuable can a good piece of advice be?**

A little section that comes in handy with interesting tutorials on various topics such as cooking times.

[www.alfaforni.com/en/blog-en/tutorial-oven/](http://www.alfaforni.com/en/blog-en/tutorial-oven/)



**Pizza dough**

Alfa presents the video recipe to prepare a perfect pizza dough.

[www.alfaforni.com/en/pizza-dough/](http://www.alfaforni.com/en/pizza-dough/)



**WRITE US**

A member of our staff will contact you as soon as possible.

[www.alfaforni.com/en/contact-us/](http://www.alfaforni.com/en/contact-us/)



## NANO WOOD-FIRED OVEN



### Ignition

- Make a small stack of seasoned kindling in the centre of the oven.
- As soon as the wood catches fire, add some small logs (3 cm diameter maximum).
- Then move the fire to the side opposite to the pyrometer and clean the floor with a brush.
- If you want to speed up the heating time, leave the door slightly open for 5 minutes and wait for the refractory stones of the floor to get completely hot.

### Maintaining a large flame

- After about 30 minutes, remove the door.
- Now you are ready to cook your yummy pizzas!
- Pizza must be baked with a high flame while bread and cakes are baked with embers and a hot oven.
- To make the most of your oven, visit the [alfafori.com](http://alfafori.com) website or buy the Alfa cookbook from your nearest dealer.

### Extinguishing the fire

- To put out the fire, close the door and wait for the ash to form.
- When the oven has cooled off, remove the ash.
- Never put embers or ash on the ground, patio or near plants or trees.

## TECHNICAL SPECS NANO WOOD-FIRED OVEN

### WARNINGS

- When firing the oven or adding a log to the fire, you might have smoke coming out of it; do not worry, this is completely normal and it is only due to thermal shock.
- NEVER overload the NANO oven with firewood; 3-4 logs are more than enough to heat it up and just add a small piece every 15 minutes to maintain the temperature.
- Clean only when the oven is off and has completely cooled.
- Do not clean the inside of the oven with chemical or toxic products. Wait till the oven has cooled off before removing the ash and wipe the floor with a damp (not wet) cloth.
- If there are traces of soot inside the oven, wait for it to cool completely and clean it with a cloth soaked in water or a specific product.
- NEVER exceed the limit temperature of 500 °C (1 000 °F).
- The oven floor is made up of four 3-cm thick firebricks: it takes a little time for them to gradually absorb and release heat and thus deliver impeccable cooking.
- The type and size of the firewood are key to build a great fire; use dry beech or oak wood with a diameter of no more than 5 cm and never place more than 4/5 logs at the same time.
- Always use the supplied wood rack so as not to overload the oven with logs and to better manage the food on the floor.

### WARNINGS

- On windy days, do not go near the oven mouth; smoke and flames could suddenly spill out of it.
- If flames shoot out of the oven due to windy conditions or improper use (too many logs or wet wood), immediately close the door and wait for the fire to die down.
- If the oven has been loaded with too much firewood and is past the limit temperature of 500 °C (1 000 °F), do not touch the external surfaces, the flue, the chimney cap and the front. In any case, we advise against touching or putting your face near the oven even during normal usage.
- NEVER disassemble the NANO wood-fired oven; this could cause damage to the appliance and jeopardize future uses. Alfa Forni is not responsible for any damage to property or people due to tampering with the appliance.
- DO NOT move the oven when it is in operation; wait for it to cool completely before budging it.
- The blackening of the upper part of the oven is the logical consequence of the combustion and does not compromise the future use of the appliance.

## CIAO AND 5 MINUTI WOOD-FIRED OVEN



### Ignition

- Make a small stack of seasoned kindling in the centre of the oven.
- As soon as the wood catches fire, add some small logs (3 cm diameter maximum).
- Then move the fire to the side opposite to the pyrometer and clean the floor with a brush.
- If you want to speed up the heating time, leave the door slightly open for 5 minutes and wait for the refractory stones of the floor to get completely hot.

### Maintaining a large flame

- After about 40 minutes, remove the door.
- Now you are ready to cook your yummy pizzas!
- Pizza must be baked with a high flame while bread and cakes are baked with embers and a hot oven.
- To make the most of your oven, visit the [alfafori.com](http://alfafori.com) website or buy the Alfa cookbook from your nearest dealer.

### Extinguishing the fire

- To put out the fire, close the door and wait for the ash to form.
- When the oven has cooled off, remove the ash.
- Never put embers or ash on the ground, patio or near plants or trees.

## TECHNICAL SPECS CIAO AND 5 MINUTI WOOD-FIRED OVEN

### WARNINGS

- When firing the oven or adding a log to the fire, you might have smoke coming out of it; do not worry, this is completely normal and it is only due to thermal shock.
  - NEVER overload the CIAO oven or 5 MINUTI oven with firewood; 3-4 logs are more than enough to heat it up and just add a small piece every 15 minutes to maintain the temperature.
  - Clean only when the oven is off and has completely cooled.
  - Do not clean the inside of the oven with chemical or toxic products. Wait till the oven has cooled off before removing the ash and wipe the floor with a damp (not wet) cloth.
  - If there are traces of soot inside the oven, wait for it to cool completely and clean it with a cloth soaked in water or a specific product.
  - NEVER exceed the limit temperature of 500 °C (1 000 °F).
  - The oven floor is made up of four 3-cm thick firebricks: it takes a little time for them to gradually absorb and release heat and thus deliver impeccable cooking.
  - The type and size of the firewood are key to build a great fire; use dry beech or oak wood with a diameter of no more than 7 cm and never place more than 3/4 logs at the same time.
  - Always use the supplied wood rack so as not to overload the oven with logs and to better manage the food on the floor.
- To avoid damaging the **CIAO oven** feet and the support surface, remember to protect the oven feet with the anti-scratch rubber profile supplied

### WARNINGS

- On windy days, do not go near the oven mouth; smoke and flames could suddenly spill out of it.
- If flames shoot out of the oven due to windy conditions or improper use (too many logs or wet wood), immediately close the door and wait for the fire to die down.
- If the oven has been loaded with too much firewood and is past the limit temperature of 500 °C (1 000 °F), do not touch the external surfaces, the flue, the chimney cap and the front. In any case, we advise against touching or putting your face near the oven even during normal usage.
- NEVER disassemble the CIAO oven or 5 MINUTI oven; this could cause damage to the appliance and jeopardize future uses. Alfa Forni is not responsible for any damage to property or people due to tampering with the appliance.
- DO NOT move the oven when it is in operation; wait for it to cool completely before budging it.
- The blackening of the upper part of the oven is the logical consequence of the combustion and does not compromise the future use of the appliance.

## 4PIZZE WOOD-FIRED OVEN



### Ignition

- Make a small stack of seasoned kindling in the centre of the oven.
- As soon as the wood catches fire, add some small logs (3 cm diameter maximum).
- Then move the fire to the side opposite to the pyrometer and clean the floor with a brush.
- If you want to speed up the heating time, leave the door slightly open for 5 minutes and wait for the refractory stones of the floor to get completely hot.

### Maintaining a large flame

- After about 40 minutes, remove the door.
- Now you are ready to cook your yummy pizzas!
- Pizza must be baked with a high flame while bread and cakes are baked with embers and a hot oven.
- To make the most of your oven, visit the [alfaforni.com](http://alfaforni.com) website or buy the Alfa cookbook from your nearest dealer.

### Extinguishing the fire

- To put out the fire, close the door and wait for the ash to form.
- When the oven has cooled off, remove the ash.
- Never put embers or ash on the ground, patio or near plants or trees.

## TECHNICAL SPECS 4PIZZE WOOD-FIRED OVEN

### WARNINGS

- When firing the oven or adding a log to the fire, you might have smoke coming out of it; do not worry, this is completely normal and it is only due to thermal shock.
- NEVER overload the 4PIZZE oven with firewood; 3-4 logs are more than enough to heat it up and just add a small piece every 15 minutes to maintain the temperature.
- Clean only when the oven is off and has completely cooled.
- Do not clean the inside of the oven with chemical or toxic products. Wait till the oven has cooled off before removing the ash and wipe the floor with a damp (not wet) cloth.
- If there are traces of soot inside the oven, wait for it to cool completely and clean it with a cloth soaked in water or a specific product.
- NEVER exceed the limit temperature of 500 °C (1 000 °F).
- The oven floor is made up of four 3-cm thick firebricks: it takes a little time for them to gradually absorb and release heat and thus deliver impeccable cooking.
- The type and size of the firewood are key to build a great fire; use dry beech or oak wood with a diameter of no more than 10 cm and never place more than 3/4 logs at the same time.
- Always use the supplied wood rack so as not to overload the oven with logs and to better manage the food on the floor.

### WARNINGS

- On windy days, do not go near the oven mouth; smoke and flames could suddenly spill out of it.
- If flames shoot out of the oven due to windy conditions or improper use (too many logs or wet wood), immediately close the door and wait for the fire to die down.
- If the oven has been loaded with too much firewood and is past the limit temperature of 500 °C (1 000 °F), do not touch the external surfaces, the flue, the chimney cap and the front. In any case, we advise against touching or putting your face near the oven even during normal usage.
- NEVER disassemble the 4PIZZE wood-fired oven; this could cause damage to the appliance and jeopardize future uses. Alfa Forni is not responsible for any damage to property or people due to tampering with the appliance.
- DO NOT move the oven when it is in operation; wait for it to cool completely before budging it.
- The blackening of the upper part of the oven is the logical consequence of the combustion and does not compromise the future use of the appliance.

## ALLEGRO WOOD-FIRED OVEN



### Ignition

- Make a small stack of seasoned kindling in the centre of the oven.
- As soon as the wood catches fire, add some small logs (3 cm diameter maximum).
- Then move the fire to the side opposite to the pyrometer and clean the floor with a brush.
- If you want to speed up the heating time, leave the door slightly open for 5 minutes and wait for the refractory stones of the floor to get completely hot.

### Maintaining a large flame

- After about 40 minutes, remove the door.
- Now you are ready to cook your yummy pizzas!
- Pizza must be baked with a high flame while bread and cakes are baked with embers and a hot oven.
- To make the most of your oven, visit the [alfaforni.com](http://alfaforni.com) website or buy the Alfa cookbook from your nearest dealer.

### Extinguishing the fire

- To put out the fire, close the door and wait for the ash to form.
- When the oven has cooled off, remove the ash.
- Never put embers or ash on the ground, patio or near plants or trees.

## TECHNICAL SPECS ALLEGRO WOOD-FIRED OVEN

### WARNINGS

- When firing the oven or adding a log to the fire, you might have smoke coming out of it; do not worry, this is completely normal and it is only due to thermal shock.
- NEVER overload the ALLEGRO oven with firewood; 3-4 logs are more than enough to heat it up and just add a small piece every 15 minutes to maintain the temperature.
- Clean only when the oven is off and has completely cooled.
- Do not clean the inside of the oven with chemical or toxic products. Wait till the oven has cooled off before removing the ash and wipe the floor with a damp (not wet) cloth.
- If there are traces of soot inside the oven, wait for it to cool completely and clean it with a cloth soaked in water or a specific product.
- NEVER exceed the limit temperature of 500 °C (1 000 °F).
- The oven floor is made up of four 3-cm thick firebricks: it takes a little time for them to gradually absorb and release heat and thus deliver impeccable cooking.
- The type and size of the firewood are key to build a great fire; use dry beech or oak wood with a diameter of no more than 7/8 cm and never place more than 3/4 logs at the same time.
- Always use the supplied wood rack so as not to overload the oven with logs and to better manage the food on the floor.

### WARNINGS

- On windy days, do not go near the oven mouth; smoke and flames could suddenly spill out of it.
- If flames shoot out of the oven due to windy conditions or improper use (too many logs or wet wood), immediately close the door and wait for the fire to die down.
- If the oven has been loaded with too much firewood and is past the limit temperature of 500 °C (1 000 °F), do not touch the external surfaces, the flue, the chimney cap and the front. In any case, we advise against touching or putting your face near the oven even during normal usage.
- NEVER disassemble the ALLEGRO wood-fired oven; this could cause damage to the appliance and jeopardize future uses. Alfa Forni is not responsible for any damage to property or people due to tampering with the appliance.
- DO NOT move the oven when it is in operation; wait for it to cool completely before budging it.
- The blackening of the upper part of the oven is the logical consequence of the combustion and does not compromise the future use of the appliance.

## NANO GAS OVEN



### Ignition

- Turn the knob anticlockwise and keep it pressed for about one minute to allow the gas to flow.
- Push the ignition button for a few seconds and wait until the oven pilot lights up while keeping the knob pressed. Turn the knob anticlockwise to maximum flame.
- Close the oven door and wait 30 minutes (40 minutes at the most) for the refractory stone floor to heat up.

### Keeping the flame lit

- After 30 minutes (40 minutes at the most) open the door.
- Now you are ready to cook your delicious pizzas!
- Set the flame depending on what you bake: medium/high for pizza, low for bread and puddings.

### Switching your gas-fired oven off

- When you have finished cooking, turn the knob clockwise to switch off the oven. Check that the main flame and the pilot are out.

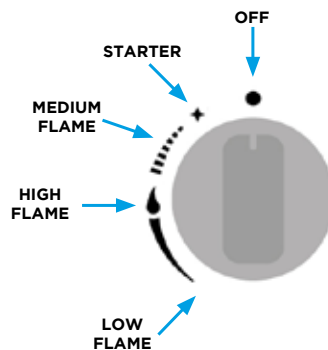
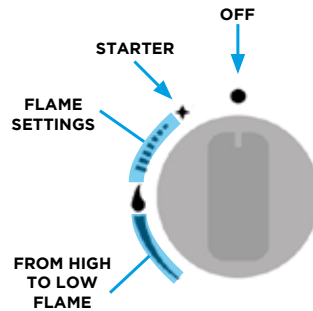

## TECHNICAL SPECIFICATIONS

### NANO GAS OVEN

### WARNINGS

- NEVER set the NANO gas-fired oven temperature above 450 °C (840 °F). Heat it to full whack for no more than 40 minutes with the door closed, then open the door and start cooking.
- Clean the oven when it's cool.
- Do not clean the inside of the oven with chemicals or toxic agents. When the oven is cool, clean it with a damp (not wet) cloth.
- If there's soot the external part of the oven, let the oven cool and scrub it with a cloth soaked in water or a specific product.
- To avoid stressing the oven, NEVER exceed the temperature indicated on the thermometer supplied by more than 450°/500°C (840°/1000°F).
- The Alfa oven can be cleaned by the fire itself through a process called "pyrolysis" (CONSULT THE USER MANUAL)

### CAUTION

- If the oven has remained at maximum flame and with the door closed for more than 40 minutes and has reached an internal temperature of more than 450°C (840°F), do not touch the external surface, the flue, the chimney cowl or the front parts of the oven. In any case, do not touch or keep your face near the oven when it is in use.
- NEVER disassemble the NANO oven so as not to compromise its use. The Alfa Forni company is not liable to damages to persons or property due to tampering or improper use of the oven.
- DO NOT handle the oven when it is running, wait for the oven to cool completely and then lift it to move it.
- External parts of the oven may turn black as a by-product of gas combustion. This is perfectly normal and does not undermine the performance of the oven.
- To replace the piezo igniter, never remove the cable from the housing, disconnect it and extract it from the rear of the igniter; then replace the piece and reconnect the cable.
- To clean/replace the burner, never remove the cable from its housing, remove it from the pilot light glow plug and reconnect it.
- If you need to replace the electric cable, disconnect it from the piezo igniter and from the pilot light, then before removing it, use a lanyard and tape it to one end of the cable to pull out the old one and thread it the new one in a hassle-free way.
- PLEASE READ THE USER MANUAL CAREFULLY!

## BRIO AND STONE OVEN GAS OVEN



### Ignition

- Turn the knob counterclockwise and keep it pressed for about one minute to allow the gas to flow.
- Push the ignition button for a few seconds and wait until the oven pilot lights up while keeping the knob pressed. Turn the knob counterclockwise to maximum flame.
- Close the oven door and wait 40-50 minutes for the refractory stone floor to heat up.

### Keeping the flame lit

- After 40-50 minutes open.
- Now you are ready to cook your delicious pizzas!
- For heating up the oven floor, keep the door closed for a couple of minutes after baking, this will allow the oven to regain the temperature lost with the previous batches.

### Switching your gas-fired oven off

- When you have finished cooking, turn the knob clockwise to switch off the oven. Check that the main flame and the pilot are out.

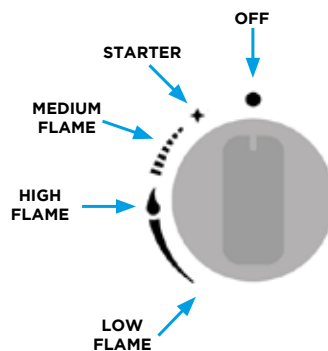
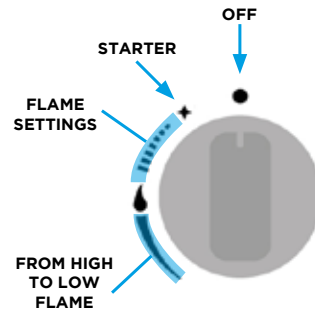

## TECHNICAL SPECIFICATIONS

### BRIO AND STONE OVEN GAS OVEN

### WARNINGS

- NEVER set the BRIO and STONE OVEN temperature above 450°C (840°F). Heat it to full whack for no more than 50 minutes with the door closed, then open the door and start cooking.
- Clean the oven when it's cool.
- Do not clean the inside of the oven with chemicals or toxic agents. When the oven is cool, clean it with a damp (not wet) cloth.
- If there's soot the external part of the oven, let the oven cool and scrub it with a cloth soaked in water or a specific product.
- To avoid stressing the oven, NEVER exceed the temperature indicated on the thermometer supplied by more than 450°/500°C (840°/1000°F).
- The Alfa oven can be cleaned by the fire itself through a process called "pyrolysis" (see user manual)

### CAUTION

- If the oven has remained at maximum flame and with the door closed for a longer time indicated by the manufacturer and has reached an internal temperature above 450°C (840°F), do not touch the external surface, the flue, the chimney cowl or the front parts of the oven. In any case, do not touch or keep your face near the oven when it is in use.
- NEVER disassemble the BRIO and STONE OVEN so as not to compromise its use. The Alfa Forni company is not liable to damages to persons or property due to tampering or improper use of the oven.
- DO NOT handle the oven when it is running, wait for the oven to cool completely and then lift it to move it.
- External parts of the oven may turn black as a by-product of gas combustion. This is perfectly normal and does not undermine the performance of the oven.
- To replace the piezo igniter, never remove the cable from the housing, disconnect it and extract it from the rear of the igniter; then replace the piece and reconnect the cable.
- To clean/replace the burner, never remove the cable from its housing, remove it from the pilot light glow plug and reconnect it.
- If you need to replace the electric cable, disconnect it from the piezo igniter and from the pilot light, then before removing it, use a lanyard and tape it to one end of the cable to pull out the old one and thread it the new one in a hassle-free way.
- PLEASE READ THE USER MANUAL CAREFULLY!

## DOLCE VITA GAS OVEN



### Ignition

- Turn the knob counterclockwise and keep it pressed for about one minute to allow the gas to flow.
- Push the ignition button for a few seconds and wait until the oven pilot lights up while keeping the knob pressed. Turn the knob counterclockwise to maximum flame.
- Close the oven door and wait 40 minutes for the refractory stone floor to heat up.

### Keeping the flame lit

- After 40 minutes open.
- Now you are ready to cook your delicious pizzas!
- For heating up the oven floor, keep the door closed for a couple of minutes after baking, this will allow the oven to regain the temperature lost with the previous batches.

### Switching your gas-fired oven off

- When you have finished cooking, turn the knob clockwise to switch off the oven. Check that the main flame and the pilot are out.

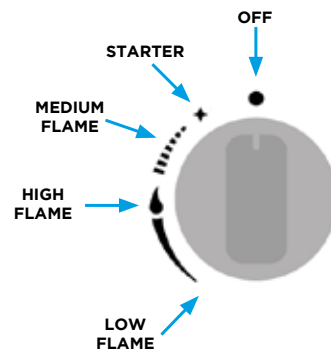
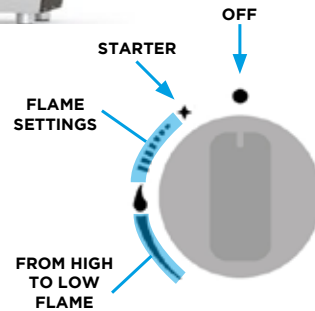

## TECHNICAL SPECIFICATIONS

### DOLCE VITA GAS OVEN

### WARNINGS

- NEVER set the DolceVita oven temperature above 450°C (840°F). Heat it to full whack for no more than 40/50 minutes with the door closed, then open the door and start cooking.
- Clean the oven when it's cool.
- Do not clean the inside of the oven with chemicals or toxic agents. When the oven is cool, clean it with a damp (not wet) cloth.
- If there's soot the external part of the oven, let the oven cool and scrub it with a cloth soaked in water or a specific product.
- To avoid stressing the oven, NEVER exceed the temperature indicated on the thermometer supplied by more than 450°C (840°F).
- The Alfa oven can be cleaned by the fire itself through a process called "pyrolysis" (see user manual)

### CAUTION

- If the oven has remained at maximum flame and with the door closed for a longer time indicated by the manufacturer and has reached an internal temperature above 450°C (840°F), do not touch the external surface, the flue, the chimney cowl or the front parts of the oven. In any case, do not touch or keep your face near the oven when it is in use.
- NEVER disassemble the Dolce Vita so as not to compromise its use. The Alfa Forni company is not liable to damages to persons or property due to tampering or improper use of the oven.
- DO NOT handle the oven when it is running, wait for the oven to cool completely and then lift it to move it.
- External parts of the oven may turn black as a by-product of gas combustion. This is perfectly normal and does not undermine the performance of the oven.
- PLEASE READ THE USER MANUAL CAREFULLY!



## TROUBLESHOOTING

### WOOD-FIRED OVENS

<b>THE OVEN SMOKES</b>	<ul style="list-style-type: none"> <li>- Check that the firewood is not too wet and the embers are not unburned.</li> <li>- Make sure that you start a fire with a strong and constant flame so as to achieve complete combustion.</li> <li>- If the oven is installed indoors, check that the chimney flue is not clogged and that the bends are no greater than 45 degrees. Also verify that the air vents are working. Close the oven door when you are doing it.</li> </ul>
<b>THE OVEN DOES NOT HEAT</b>	<ul style="list-style-type: none"> <li>- Check that the fire is on one side of the oven and not near the mouth.</li> <li>- Heat up the oven with a strong fire for 20 minutes.</li> <li>- Do not stack firewood on top of the glowing embers.</li> <li>- Gradually add wood to the fire.</li> </ul>
<b>THE OVEN COOLS DOWN QUICKLY</b>	<ul style="list-style-type: none"> <li>- Check that no moisture or water have seeped into the oven.</li> <li>- Maybe you are lighting the oven for the first time, or you are doing it after the oven stood idle for too long.</li> <li>- Refrain from making short-lived fires that would not heat the oven thoroughly.</li> </ul>
<b>THE FLAMES SPILL OUT OF THE OVEN OR OF THE CHIMNEY CAP</b>	<ul style="list-style-type: none"> <li>- Make sure the fire does not get too strong and put out the flames spilling out of the oven by leaving the door ajar.</li> </ul>
<b>THE OVEN DOES NOT COOK AS YOU WOULD LIKE</b>	<ul style="list-style-type: none"> <li>- Check that the oven is at the right temperature.</li> <li>- Make sure that the oven maintains the ideal temperature throughout the cooking. Use the door as a temperature control; open or close it to raise or lower the heat.</li> </ul>

## TROUBLESHOOTING

### GAS-FIRED OVENS

<b>THE OVEN COOLS DOWN TOO EARLY</b>	<ul style="list-style-type: none"> <li>- Check that no moisture or water have seeped into the oven.</li> <li>- Maybe you are lighting the oven for the first time, or you are doing it after the oven stood idle for too long.</li> <li>- Refrain from making short-lived fires that would not heat the oven thoroughly.</li> <li>- Check that the gas burner is working and close the door.</li> </ul>
<b>THE OVEN DOES NOT COOK AS YOU WOULD LIKE</b>	<ul style="list-style-type: none"> <li>- Check that the oven is at the right temperature.</li> <li>- Heat up the oven with a strong fire for 10 minutes.</li> <li>- Make sure that the oven maintains the ideal temperature throughout the cooking. Use the door as a temperature control; open or close it to raise or lower the heat.</li> <li>- If the nozzles are clogged, contact a qualified gas technician.</li> </ul>
<b>THE NOZZLES ARE CLOGGED</b>	<ul style="list-style-type: none"> <li>- contact an expert maintenance technician</li> </ul>
<b>THE FLAME DOES NOT IGNITE</b>	<ul style="list-style-type: none"> <li>- Check that the thermocouple is intact and functioning.</li> <li>- Verify that the thermocouple is mounted near the pilot.</li> <li>- Check correct gas pressure.</li> <li>- Make sure you have fitted the correct pressure regulator.</li> </ul>

**For expert advice, contact us at [www.alfaforni.com](http://www.alfaforni.com).**

**Alfa is not responsible for veins, scratches or hairline cracks in the oven floor as they are an intrinsic property of the material.**

**If you need any assistance, feel free to contact us at [info@alfaforni.com](mailto:info@alfaforni.com) or call the number +39.0775.7821**



