



OCHAIN active spider user manual:
installation, setup and maintenance.



Limited warranty and disclaimer

OCHAIN active spider is a patent pending component by Ochain srl.

Ochain srl guarantees its products against materials or manufacturing defects for a period of 2 years starting from the date of purchase by the first buyer, proven by the receipt or by the invoice in case of a direct purchase.

The defect has to be communicated by the first owner to the dealer in case of non-direct purchase or by mail/e-mail to info@ochain.bike in case of direct purchase. In case of return, just after our authorization, transport charges and risks are at customer cost.

Ochain srl recommends to follow the provided instructions for the correct usage and installation. In case instructions are not followed, warranty expires.

OCHAIN manuals can be found and downloaded online on website www.ochain.bike
Warranty do not cover missed, wrong or bad ordinary or extraordinary maintenance, damages caused by wrong assembly or with non-compatible components assembly, impacts, falls or accidents, normal consumption, alteration or modification of the original product and damages caused by transport.

If Ochain srl, after checking the product, finds that the damage is due to one of the reasons mentioned above, the warranty request will not be accepted and the defective item is sent back to the plaintiff who supports the shipping fees.

Ochain srl is not responsible for damages or injuries caused by improper installation or wrong usage of the product

To the extent allowed by local law, except for the obligations specifically set forth in this warranty statement, in no event shall Ochain srl or its third party suppliers be liable for direct, indirect, special, incidental or consequential damages.



Safety warnings

THIS USER MANUAL CONTAINS IMPORTANT AND USEFUL INFORMATION REGARDING THE PROPER INSTALLATION, OPERATION, CARE AND MAINTENANCE OF YOUR OCHAIN PRODUCT. CAREFULLY READ, FOLLOW AND UNDERSTAND THE INSTRUCTIONS AS DETAILED IN THIS USER'S MANUAL. KEEP THIS MANUAL IN A SAFE PLACE FOR FUTURE REFERENCE.

If you have any doubt whatsoever regarding your ability to install or service this product, please consult OCHAIN user manual, OCHAIN website and seek the assistance of a professional bicycle mechanic. Do not perform any modifications or adjustments that are not outlined in this manual.

Incorrect installation or servicing may impair performance, and could result in a

dangerous situation leading to serious injury or death.

Components that have experienced excessive wear, deformations or impacts or other damage need immediate professional inspection or replacement. Please have this product regularly inspected by a qualified mechanic for any signs of wear or damage.

Failure to perform necessary and essential maintenance could drastically reduce the service life of your OCHAIN product and reduce its performance.

If you have any questions, please contact a professional bike mechanic or ask OCHAIN for support at info@ochain.bike.



Ochain srl company informations

Ochain srl · Via Carlo Avegno 1 · 21100 Varese (VA) · ITALY

Please note all instructions are subject to change for improvement without notice.

Please visit www.ochain.bike for periodic tech updates.

For feedback and support write an email to info@ochain.bike



Maintenance

Inspect your OCHAIN product for wear, looseness or damage including cracks, dents and serious scratches before each ride and after every fall or crash.

Do not use your OCHAIN product until it has been thoroughly inspected, repaired or replaced.

PERIODICALLY CHECK THE TIGHTENINGS. INCORRECT TIGHTENING MAY CAUSE MALFUNCTIONING OR BREAKAGE.



OCHAIN active spider specifications

Main material:

Al Alloy 7075 T6

Surface treatments:

Black hard anodizing (MOD. NERO)

Custom precious hard coating (MOD. PREGIO)

Dimensions:

93 mm x 93 mm x 13 mm

Weight:

128 g

Chainline*:

52 mm (Boost only).

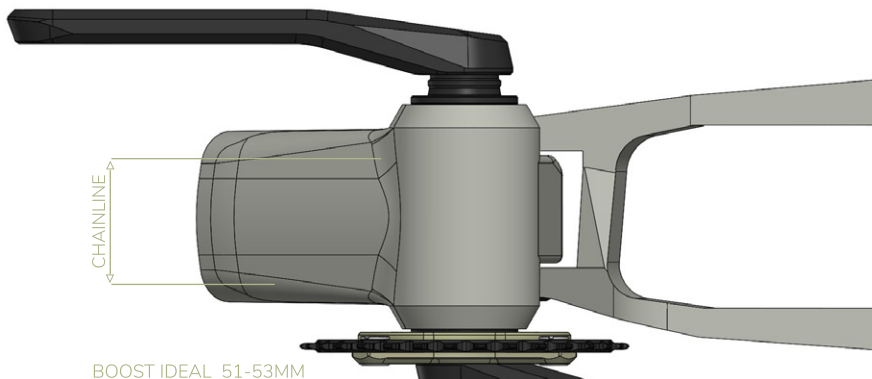

**Chainline is the distance between the centerline of your frame and the average centerline of your chainring.*

Compatibility:

OCHAIN is a 1X 104 BCD** Boost active spider

It replaces the stock chainring spider or direct mount chainring so that you can run your chainring on SRAM, RaceFace, Ethirteen and INGRID cranks direct mount standards.



**Bolt Circle Diameter or BCD is the imaginary circle that passes through the center of all the chainring mounting holes.



OCHAIN active spider installation

Disassemble your crankset from the frame, referring to the manufacturer's manual or to a professional bicycle mechanic.

Remove currently installed chainring configuration from the crank arm.

NOTE: If your bike already mounts a BCD 104 standard chainring bolted to the spider and you want to use it on OCHAIN, remove the chainring from the spider.

For safety and performance reasons, make sure to check good conditions of chainring with the help of a professional bicycle mechanic.

Install your chainring on OCHAIN using 4 standard chainring nuts.

WARNING: OCHAIN fits only with 5 mm female length chainring nuts!

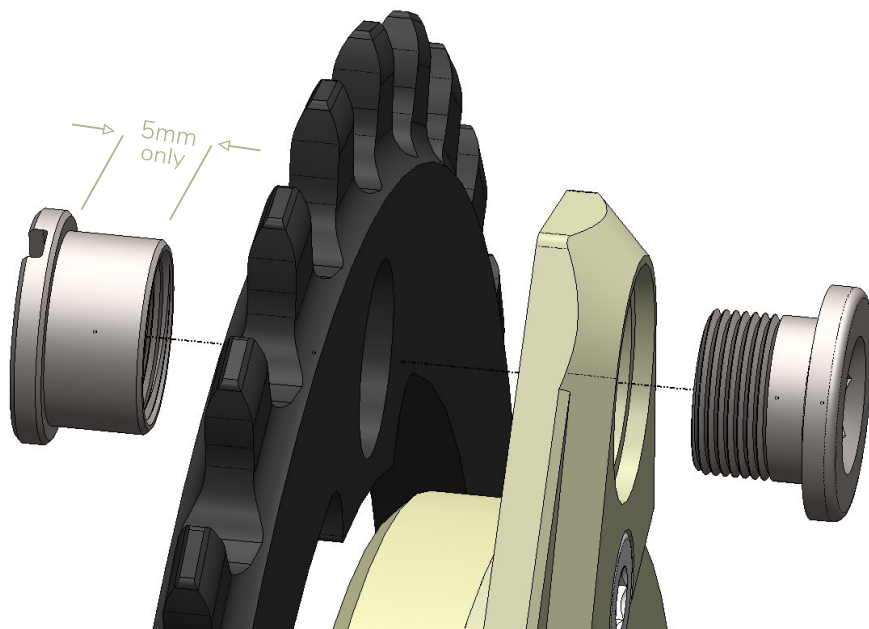

Use Loctite medium on bolts.

Tighten all four chainring bolts to chainring nuts with the recommended nut manufacturer's tightening.

Use some grease on the external of the chainring bolts and tighten with a wrench **FULLY ENGAGED** in the bolt.

NOTE: For a perfect result we recommend to use our OCHAIN titanium chainring bolts and nuts (tightened to 10 Nm) and Carbon-T chainrings.

Align OCHAIN with your crank arm as shown in the picture.
Lasered mark signs ">>>" on OCHAIN surface show the correct crank arm position.

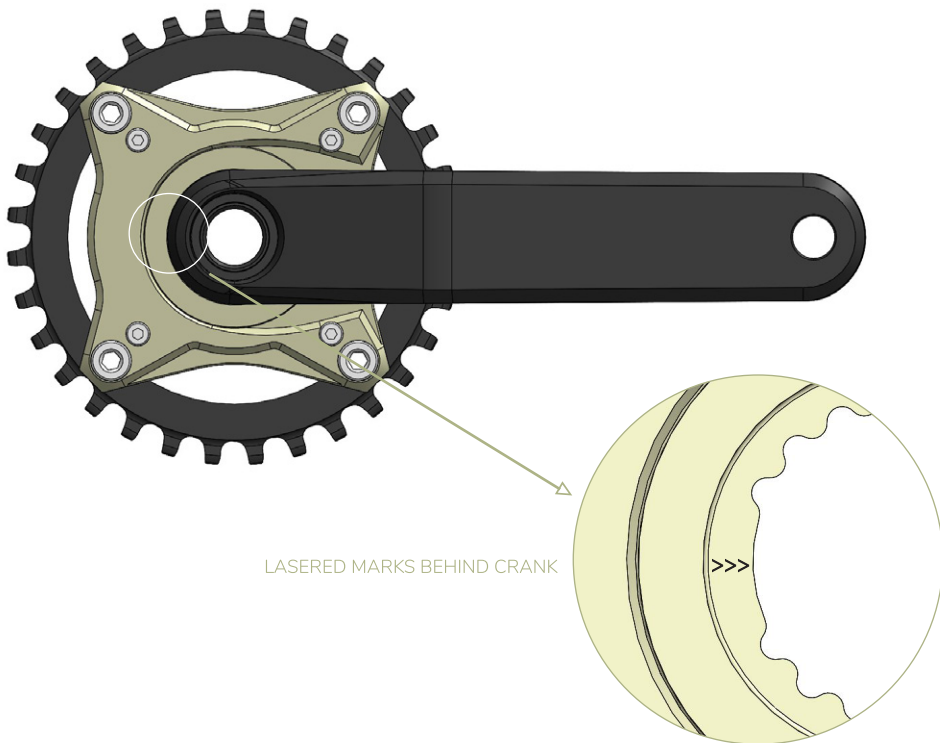

Finally re-assemble your crankset referring to the manufacturer's manual or to a professional bicycle mechanic.



OCHAIN active spider different setups

Pedal kickback is measured in degrees to indicate how much the pedals rotate backwards at a given point in the suspension travel.

OCHAIN comes with a ready to ride 6° setup and two alternative setup kits. Tailor your OCHAIN settings by changing provided OCHAIN elastomers: 6°, 9° and 12°.

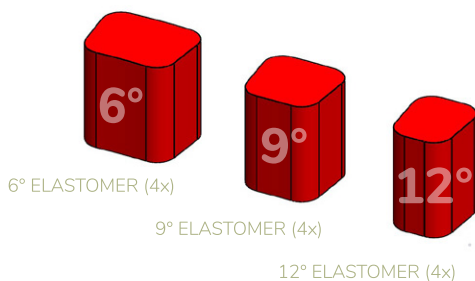

Please refer to our website for detailed setup suggestions.

Disassemble your crankset, always referring to the manufacturer's manual or to a professional bicycle mechanic. Remove OCHAIN from the crank arm.

For a quick elastomers replacement is possible to do this work without removing the chainring from OCHAIN.

Clean OCHAIN perfectly from dust and mud with a clean cloth.

NOTE: Please do not use any chemical products to preserve our environment.

On a clean working flat and stable surface, place OCHAIN as shown in the picture.

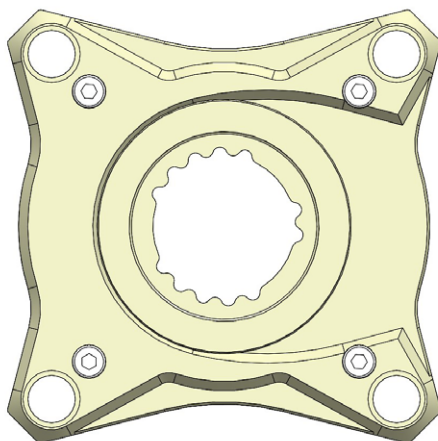

Unscrew all four m4x8 mm bolts using a 2.5 mm hex wrench.

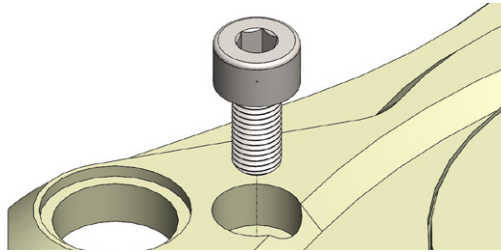

Carefully lift only the upper element of OCHAIN so that small parts, elastomers and springs will not lose their positioning.

NOTE: use one finger to hold and maintain the bottom part of OCHAIN laid on a flat stable surface.

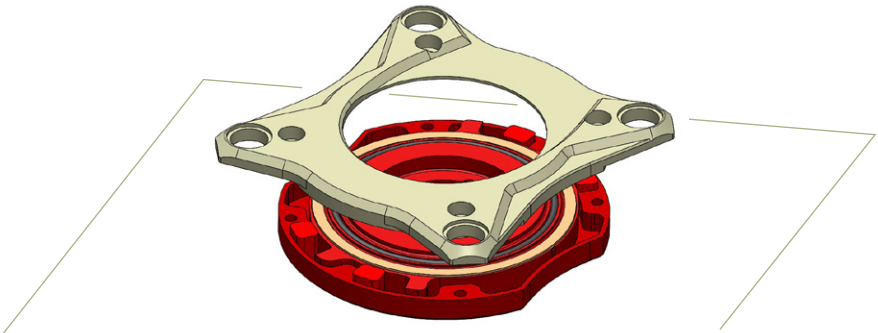

Whenever everything goes wrong and you find yourself with pieces around, follow dedicated instructions video on OCHAIN Youtube channel.

Every time you open OCHAIN take the opportunity to wipe it with a clean cloth from eventual dirt and old grease, then regrease with commercial lithium grease as shown on maintenance video on OCHAIN Youtube channel.

Replace all four elastomers with chosen ones, placing them on the right side as shown.

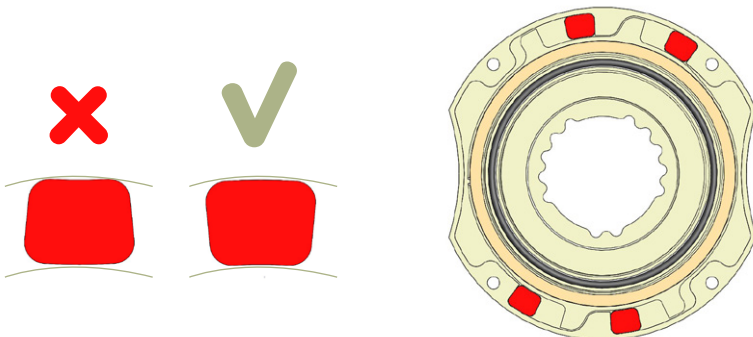

Close OCHAIN referring to lasered alignment marks "▲▼"

IMPORTANT: Check OCHAIN is perfectly closed.

Use Loctite medium on bolts. Tighten all four m4x8 mm bolts using a 2,5 mm hex wrench.

Align OCHAIN with your crank arm. Lasered mark signs ">>>" on OCHAIN surface show the correct crank arm positioning.

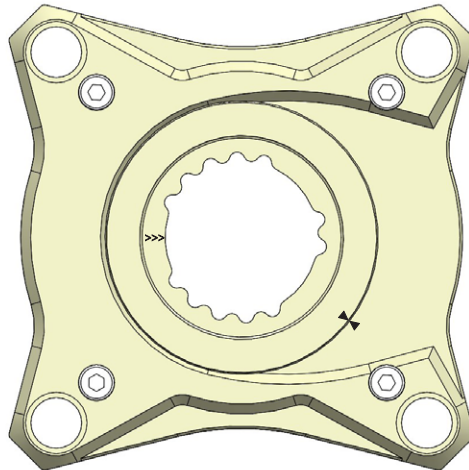

Finally re-assemble your crank referring to the manufacturer's manual or to a professional bicycle mechanic.



OCHAIN active spider maintenance

For OCHAIN care and maintenance guidelines please see this video on OCHAIN Youtube channel.