

**Whitfield Advantage I
Pellet, Freestanding & Insert, WP2
MODEL YEARS: 1985 - 1989 (Serial # 1001 - 7400)
(click the link for parts and ordering)**

PART #	DESCRIPTION
Door Parts	
12045105	Clip, Glass (bent) - 2 per pkg.
12045100	Clip, Glass (flat/side) - 2 per pkg.
61057201	Gasket Kit, Glass, WP2 (10 feet; 5/8", black with adhesive)
12146400	Glass, Center (13" x 9")
12146401	Glass, Side (4.3" x 9")
18140046	Handle Kit, Door (Oak) - 2 per pkg.
24220507	Hinge Pin, Door, Adv. I (1/4")
Body Components	
12055205	Clip for Brass Glass Trim - 12 per pkg.
12252900	Trim Kit, Brass (For Side Panel - Freestanding) - 2 per pkg.
12352901	Trim Kit, Brass (For Side Panel - Insert) - 2 per pkg.
Electrical Parts	
12056010	Blower Kit, Exhaust (Motor & Housing)
12156009	Blower, Exhaust Kit (Complete Teardown)
24220302	Blower, Room Air (gray; Dayton 4C006)
12147705	Disc, High Limit (L250-30F; 60T21, Bakolite) - 3 per pkg.
12057601	Disc, Low Limit (Ceramic, F140-30F; 49T style) - 3 per pkg.
61057210	Gasket, Exhaust Blower, Fan Mount, 5 per pkg.
61020015	Gasket, Exhaust Blower, Tear Down, 1 per pkg.
12056108	Impeller, Exhaust Blower
12046300	Motor, Auger (Drives pellet feed auger)
12050504	Potentiometer Kit, Feed Control (blue wires; replaces 6-second timer and potentiometer)
12058200	Power Cord w/Cable Connectors (8 ft.)
12145903	Pressure Switch
12056003	Hose, Pressure Switch, 19" (may need to be cut to size) - 3 per pkg.
24220901	Rheostat, Blower Speed Control
12050702	Switch, On/Off
21040407	Timer Kit, RK, WP1 (replaces OMRON and Dayton timers)
12040403	Timer, 1-second Recycling, SSAC
24220405	Timer, 30-minute, ACP, Adv. I
12040404	Timer, 30-minute, SSAC
Auger System Components	
12152202	Auger Shaft Kit (Includes set collar and screw)
12051100	Bushing, Auger (Oilite) - 12 per pkg.
12041300	Collar, Auger Set (Includes screw) - 3 per pkg.
61050003	Gasket, Auger End Plate (Neoprene) - 5 per pkg.
12153900	Plate, Auger End (w/ Nylotron Bushing)

Advantage I Whitfield Pellet

(click the link for parts and ordering)

Miscellaneous Parts

[61057204](#)

Gasket, Ash Pan (flat 3/8" x 1/8" x 10')

[19L92](#)

Paint, Charcoal (12 oz. Spray #6201)

[73020302](#)

Paint, Flat Black (12 oz. Spray #6304)

[73020303](#)

Paint, Goldenfire Brown (12 oz. Spray #6230)

[12150916](#)

Scraper Rod Kit

[61057206](#)

Gasket, Donut Burnpot (1/4" x 2 1/2") - 12 per pkg.

Firebox Parts

[17100061](#)

Baffle, Heat Exchange

[24250800](#)

Burnpot, Adv. I (*SN 1001 - 7216) Note: The Burnpot holds the Burn Grate, which is where the fire

[24250700](#)

Grate, Burn - Conventional Drop in Grate, WP2, ADV 1 S# 1001-7216

[24220200](#)

Firebrick Ceraboard Kit, 14 x 21 x 1", cut to fit

* SN - Stove serial number range, parts are compatible with:

">" = greater than # indicated, "<" = less than # indicated, "-" = numbers within range.

Advantage II Whitfield Pellet

Advantage II

Pellet, Freestanding & Insert, WP2

MODEL YEARS: 1989 - 1990 (Serial # 7401 - 18144)

(click the link for parts and ordering)

PART

DESCRIPTION

Door Parts

25220306	Bolt, Door Hinge Swing, WP2 (5/16"; to approx. *SN 9700)
12045105	Clip, Glass (bent) - 2 per pkg.
12045100	Clip, Glass (flat/side) - 2 per pkg.
61057100	Gasket Kit, Door Rope, WP2/WP4 (1/2" round; 7 ft.; firm)
61057201	Gasket Kit, Glass, WP2 (10 feet; 5/8", black with adhesive)
61057204	Gasket Kit, Glass/Ashpan, WP2 (10 feet; 3/8" x 1/8")
12146400	Glass, Center (13" x 9")
12146401	Glass, Side (4.3" x 9")
12054200	Handle Kit, Door, Oak, WP2/WP4 - 2 per pkg.
12140316	Latch Kit, Door (with Oak Handle) - Black
72045000	Shoulder Bolt Kit, Door Latch
72045001	Shoulder Bolt Kit, Door Latch Boss

Body Components

12150600	Ash Pan Kit (through *SN 32210)
12055205	Clip for Brass Glass Trim - 12 per pkg.
12052901	Clip, Brass (For Side Panel Trim - 1 foot; must be cut to length)
12145200	Trim Kit, Brass (for Center Glass)
12145202	Trim Kit, Brass (for Side Glass, left and right side)
12352901	Trim Kit, Brass (for Side Panel - Insert) - 2 per pkg.
12252900	Trim Kit, Brass (For Side Panel, WP2 - Freestanding) - 2 per pkg.
12150607	Trim with Magnets, Ash Pan (Black)
12155002	Trivet, WP2 (*SN 7401 & up) - Black Painted
12155003	Trivet, WP2 (*SN 7401 & up) - Brown Painted (Obsolete, Limited Quantities Available) (Obsolete) Trivet, WP2 (*SN 7401 & up) - Slate Painted (Substitute 12155002)

Electrical Parts

25244202	Transduct Adapter Kit, Room Air Blower, WP2 (*SN 7108 - 12102)
12056010	Blower Kit, Exhaust (Motor & Housing)
12156009	Blower, Exhaust, Teardown, Complete (Includes low limit disc, 12057601, and gasket, 61057210)
12146109	Blower, Room Air, Hardwasher (w/ 4 nuts) **
25250801	Control Board, RK, WP2 (SN 7401 - 18144)
12147705	Disc, High Limit (L250-30F; 60T21, Bakolite) - 3 per pkg.
12057601	Disc, Low Limit (Ceramic, F140-30F; 49T style) - 3 per pkg.
61057210	Gasket, Exhaust Blower Mounting (1/8" lytherm) - 5 per pkg.
61020015	Gasket, Exhaust Blower, Tear Down, 1 per pkg.
12056108	Impeller, Exhaust Blower
12051400	Knob, Control Board Heat Output (*SN 7401 & up) - 2 per pkg.
12046300	Motor, Auger (Drives pellet feed auger)
12058200	Power Cord w/ Cable Connectors (8 ft.)

Advantage II Whitfield Pellet

(click the link for parts and ordering)

[13640014](#) Pressure (Vacuum) Switch Kit, WP2 (yellow label, *SN 10348 - 18144)

[13656003](#) Hose, Pressure Switch, 19" (may need to be cut to size) - 3 per pkg.

[12048001](#) Terminal Block Kit (8 position; screw terminals)

Auger System Components

[12041300](#) Collar, Auger Set Collar (Includes screw) - 3 piece

[61050003](#) Gasket, Auger End Plate (Neoprene) - 5 per pkg.

[12153900](#) Plate, Auger End (w/ Nylatron Bushing) WP2

[12152202](#) Auger Shaft w/Collar and Screw

Freestanding Only Parts

[12252900](#) Trim Kit, Brass (for Side Panel, WP2 - Freestanding) - 2 per pkg.

Insert Only Parts

[12351411](#) Cover, Rear Hopper (Insert) - Black

[12351412](#) Cover, Rear Hopper (Insert) - Brown

[12351413](#) Cover, Rear Hopper (Insert) - Slate

[12351414](#) Lid with Hinge, Hopper (WP2 - Insert) - Black

[12351415](#) Lid with Hinge, Hopper (WP2 - Insert) - Brown

[12351416](#) Lid with Hinge, Hopper (WP2 - Insert) - Slate

[12301406](#) Lid, Hopper Front (Insert; old-style)

[12352901](#) Trim Kit, Brass (For Side Panel - Insert) - 2 per pkg.

Miscellaneous Parts

[12151300](#) Damper (rod welded to plate; *SN <32210)

[61057204](#) Gasket, Ash Pan

[12125400](#) Handle, Damper (Spring-Type, 1-3/8"L x 5/16" Dia.)

[73020304](#) Paint, Enamel, Metallic Gloss - Black

[73020305](#) Paint, Enamel, Metallic Gloss - Brown

[73020306](#) Paint, Enamel, Metallic Gloss - Slate

[12151301](#) Plate, Damper Gasket - 6 per pkg.

[12150916](#) Scraper Rod Kit, Tube (WP2 - *SN 1001 & up)

[25220204](#) Tee, Air Bleed, WP2 (6532AA; *SN 7401 - 18144; allows air to pass through pressure tap to prevent blockage from fly ash)

[12055500](#) Tool, Ash Pan/Grate Scraper

[12021101](#) Bushing, Nylatron (.500 O.A.L.)

[12051100](#) Bushing, Orlite

[72023013](#) Nut, Hex (for Nylatron Bushing)

Firebox Parts

[12150800](#) Burnpot Kit (use with grate #12150700; *SN 7217 - 59831) Note: The Burnpot holds the Burn Grate, which is where the fire takes place.

[12140102](#) Clip Kit, Firebrick (WP2 - pkg. of 2 clips w/fasteners) *SN < 18144

[24256500](#) Firebrick Ceraboard Kit, 14 x 21 x 1" (cut to fit) *SN <18144

[12146500](#) Firebrick Set (brick pattern; all 3 panels)

[61057206](#) Gasket, Burnpot "O"-ring (WP2; 1-1/4" x 2.5") - 12 per pkg.

[12150700](#) Grate (use with burnpot #12150800) *SN 7217 - 43377

[12151264](#) UltraGrate Retrofit Kit with Base

[12141920](#) Baffle, Heat Exchange

* SN - Stove serial number range, parts are compatible with:

">" = greater than # indicated, "<" = less than # indicated, "-" = numbers within range.

** Units within this serial number range, SN 7108-12102, will also require a Transduct Adaptor Kit (P/N 25244202) for this later style blower to fit (OR) order the old style blower (P/N 24220302).

Advantage II-T III Whitfield Pellet

Advantage II-T & III

Pellet, Freestanding & Insert, WP2

ADVANTAGE II-T MODEL YEARS: 1990 - 2000 (Serial # 18145 & up)

ADVANTAGE III MODEL YEARS: 1991 - 1996 (Serial # 18145 & up)

(click the link for parts and ordering)

PART

DESCRIPTION

Door Parts

12150505	Bracket Kit, Window Wash, '93 Adv. (through *SN 81338)
12150506	Bracket Kit, Window Wash, '94 Adv. (*SN 81339 & up)
12140510	Bracket, Door Hinge (WP2, *SN 42748 & up)
12045105	Clip, Glass (bent) - 2 per pkg.
12140225	Clip, Glass (bent/bottom) for Single-Piece Glass, Adv. III
12045100	Clip, Glass (flat/side) - 2 per pkg.
12150511	Door Assembly, Complete, Advantage III - Black
12150512	Door Assembly, Complete, Advantage III - Brown
12150514	Door Assembly, Complete, Advantage III - Slate
12150510	Door Assembly, Complete, Advantage II-T - Black (3 pc)
12150520	Door Assembly, Complete, Advantage II-T - Brown (3 pc)
12150540	Door Assembly, Complete, Advantage II-T - Slate (3 pc)
61057100	Gasket Kit, Door Rope (WP2/WP4; 1/2" round; 7 ft.; firm)
61057201	Gasket Kit, Glass (WP2; 10 feet; 5/8", black with adhesive)
12146402	Glass Kit, Replacement (Advantage III; Includes Gasket)
12146400	Glass, Center (13" x 9")
12146401	Glass, Side (4.3" x 9")
12054200	Handle Kit, Oak Door (WP2/WP4) - 2 per pkg.
12150507	Hinge Pin, Door (WP2/WP3; 5/16" x 1-1/2"; *SN 18145 & up) - 2 per pkg.
12051409	Knob, Control Panel Door (round, black) - 6 per pkg.
12140316	Latch Kit, Door (with Oak Handle) - Black
72045000	Shoulder Bolt Kit, Door Latch
72045001	Shoulder Bolt Kit, Door Latch Boss (WP2)

Body Components

12055205	Clip for Brass Glass Trim - 12 per pkg.
12052901	Clip, Brass Clip (for Side Panel Trim; 1 foot - must be cut to length)
12145200	Trim Kit, Brass (for Center Glass)
12145202	Trim Kit, Brass (For Side Glass, left and right side)
12352901	Trim Kit, Brass (For Side Panel, WP2 - Insert) - 2 per pkg.
12252900	Trim Kit, Brass (for Side Panel; WP2 - Freestanding) - 2 per pkg.
12145203	Trim Kit, Brass (For Single-Piece Glass, WP2, Adv. III)
12155001	Trivet - Gold Plated
12155002	Trivet, WP2 (*SN 7401 & up) - Black Painted
12155003	Trivet, WP2 (*SN 7401 & up) - Brown Painted (Obsolete, Limited Quantities Available)

Electrical Parts

12056010	Blower Kit, Exhaust (Motor & Housing)
12156009	Blower, Exhaust (Teardown, Complete)
12146109	Blower, Room Air (52L02)

Advantage II-T III Whitfield Pellet**(click the link for parts and ordering)**

12045901	Control Board Cable Assembly (6-pin connector)
12055902	Control Board Kit
12147705	Disc, High Limit (Bakolite, L250-30F; 60T21) - 3 per pkg.
12057601	Disc, Low Limit (Ceramic, F140-30F; 49T style) - 3 per pkg.
12155908	Fuse, 3.5-amp, Fast Acting (use with ICM control board) - 12 per pkg.
12055908	Fuse, 6-amp, Fast Acting, LF235006 (for SSAC control board) - 12 per pkg.
12155907	Fuse Holder, In-line (w/fuse)
12140213	Igniter Cartridge
12040003	Igniter Cartridge, 6 pack
12056108	Impeller, Exhaust Blower
12046300	Motor, Auger (Drives pellet feed auger)
72050004	Plug, Self-Igniter
12058200	Power Cord w/ Cable Connectors (8 ft.; *SN 1001 - 75863)
12058820	Power Cord with Molded End, Detachable (8 ft.; 52L17; *SN 75864 & up)
16050001	Pressure Switch Kit (FS6460-910;red label;shuts off auger if exhaust becomes blocked),12145903
12048001	Terminal Block Kit (8 position; screw terminals; *SN 7401 - 75863)
16050205	Thermostat, Wall, Honeywell
16020204	Wire, Thermostat, 20' coil - 18 gage
12158800	Wiring Harness, WP2 (*SN 75864 & up)

Auger System Components

12152202	Auger Kit (auger and set collar/screw)
12051100	Bushing, Auger (Oilite) - 12 per pkg.
12041300	Collar, Auger Set Collar (Includes screw) - 3 per pkg.
61050003	Gasket, Auger End Plate (Neoprene) - 5 per pkg.
12153900	Plate, Auger End (w/ Nylontron Bushing)

Ash Pan Door, Ash Trap Baffles & Related Parts

12156500	Ash Pan (*SN 32211 & up)
12150600	Ash Pan (through *SN 32210)
12141920	Baffle Kit, Ash Trap, Adv. '94 (left and right side; *SN 75864 & up)
12157601	Door Assembly, Ash Pan (Adv. '94, *SN 75864 & up) - Black
12157602	Door Assembly, Ash Pan (Adv. '94, *SN 75864 & up) - Brown
12157603	Door Assembly, Ash Pan (Adv. '94, *SN 75864 & up) - Slate
12157510	Door w/ Slam Latch, Ash Pan (WP2, through *SN 59831) - Black
12157520	Door w/ Slam Latch, Ash Pan (WP2, through *SN 59831) - Brown
12157540	Door w/ Slam Latch, Ash Pan (WP2, through *SN 59831) - Slate
61057204	Gasket Kit, Ash Pan (3/8" x 1/8" x 10')
12151412	Knob, Ash Pan Door - 6 per pkg.
12121017	Knob, Ash Pan Slam Latch, WP2 - pkg. of 12
12121007	Latch, Ash Pan Slam, WP2
12040609	Magnet, Ash Pan Trim (2" x 3/4" x 1/4") - 3 per pkg.
12140104	Plug Kit, Ash Slide
12055500	Scraper Tool, Ash Pan/Grate
12107800	Striker, Ash Pan (WP2, through *SN59831)
12150607	Trim, Ash Pan with Magnets (*SN 32211 & up) - Black, 12150606
12150608	Trim, Ash Pan with Magnets (*SN 32211 & up) - Brown
12150609	Trim, Ash Pan with Magnets (*SN 32211 & up) - Slate

Freestanding Only Parts

12251406	Lid Assembly, Hopper (with hinge; Freestanding) - Black, 12251405
12251407	Lid Assembly, Hopper (with hinge; Freestanding) - Brown
12251408	Lid Assembly, Hopper (with hinge; Freestanding) - Slate

Advantage II-T III Whitfield Pellet

(click the link for parts and ordering)

12252523	Panel, EZ Open, Left Side (*SN 42728 & up) - Black, 12254000
12252524	Panel, EZ Open, Left Side (*SN 42728 & up) - Brown
12252525	Panel, EZ Open, Left Side (*SN 42728 & up) - Slate
12252526	Panel, EZ Open, Right Side (*SN 42728 & up) - Black, 12256000
12252527	Panel, EZ Open, Right Side (*SN 42728 & up) - Brown
12252528	Panel, EZ Open, Right Side (*SN 42728 & up) - Slate
12252601	Panel, Rear Inspection - Black
12252602	Panel, Rear Inspection - Brown
12252603	Panel, Rear Inspection - Slate
12251401	Panel, Top, F S, Black
12251402	Panel, Top, F S, Brown
12251403	Panel, Top, F S, Slate
12252900	Trim Kit, Brass (for Side Panel, WP2 - Freestanding) - 3 per pkg.

Insert Only Parts

12351411	Cover, Rear Hopper (Insert) - Black
12351412	Cover, Rear Hopper (Insert) - Brown
12351413	Cover, Rear Hopper (Insert) - Slate
12355410	Hearth Support Kit, (Insert Pedestal; WP2 ; Black)
12355420	Hearth Support Kit, (Insert Pedestal; WP2 ; Brown)
12355440	Hearth Support Kit, (Insert Pedestal; WP2 ; Slate)
12351414	Lid with Hinge, Hopper (WP2, Insert) - Black
12351415	Lid with Hinge, Hopper (WP2, Insert) - Brown
12351416	Lid with Hinge, Hopper (WP2, Insert) - Slate
12352521	Panel, EZ Open, Left Side (Insert; *SN 42728 & up) - Black
12352522	Panel, EZ Open, Left Side (Insert; *SN 42728 & up) - Brown
12352523	Panel, EZ Open, Left Side (Insert; *SN 42728 & up) - Slate
12352525	Panel, EZ Open, Right Side (Insert; *SN 42728 & up) - Black
12352526	Panel, EZ Open, Right Side (Insert; *SN 42728 & up) - Brown
12352527	Panel, EZ Open, Right Side (Insert; *SN 42728 & up) - Slate
12351407	Panel, Top Front - Black
12351408	Panel, Top Front - Brown
12351409	Panel, Top Front - Slate
12352901	Trim Kit, Brass (for Side Panel - Insert) - pkg. of 2
12325000	Trim Kit, Surround Extension, WP2
12348000	Trim, Gold Surround (for large Surround)
12347000	Trim, Gold Surround (for medium Surround)
12346000	Trim, Gold Surround (for small Surround)

Miscellaneous Parts

12140103	Air Deflector Plate Kit, Room Air, WP2 (*SN 42728 - 58924)
12050039	Casting, Aluminum Exhaust Transduct (*SN 66080 & up)
12055205	Clip, Window Trim (12 per pkg.)
12151307	Collar, Damper Rod Set (Includes Screw; 1/4" I.D.; *SN 18145 - 32210) - 4 per pkg.
12151300	Damper (rod welded to plate; through *SN 32210)
12125400	Handle, Damper (Spring-Type, 1-3/8"L x 5/16"Dia.; through *SN 32210)
12154201	Handle, Oak Damper (*SN 32211 & up) - 3 per pkg.
12056003	Hose, Pressure Switch
61050003	Gasket, Auger
61057210	Gasket, Exhaust Blower Mounting (1/8" lytherm) - 5 per pkg.

Advantage II-T III Whitfield Pellet**(click the link for parts and ordering)**

- [61020015](#) Gasket, Exhaust Blower, Tear Down, 1 per pkg.
- [61057203](#) Gasket, Room Air Blower (5 per pkg.)
- [13656003](#) Hose, Pressure Switch, 19" (may need to be cut to size) - 3 per pkg.
- [12056003](#) Hose, Pressure Switch, WP2 (orange; silicone; 1/4" dia. x 4.5") - 3 per pkg.
- [12051400](#) Knob, Control Board Heat Output (*SN 7401 & up) - 2 per pkg.
- [73020304](#) Paint, Enamel, Metallic Gloss - Black
- [73020305](#) Paint, Enamel, Metallic Gloss - Brown
- [73020306](#) Paint, Enamel, Metallic Gloss - Slate
- [12151308](#) Plate Assembly, Damper (use with #12121306; *SN 32211 & up)
- [12151301](#) Plate, Damper Gasket - 6 per pkg.
- [72050004](#) Plug, Self-Igniter
- [12151306](#) Rod Kit, Damper (1/4" rod; includes Allen wrench; *SN 32211 & up)
- [12150916](#) Scraper Rod Kit, Tube (WP2, *SN 1001 & up)
- [12055600](#) Wrench, Damper Hex, WP2 (3/32") - 6 per pkg.

Firebox Parts

- [12150804](#) Burnpot & Grate Kit (2.5")
- [12150802](#) Burnpot & Grate Kit (4-1/2"; *SN 18145 - 59831)
- [12150803](#) Burnpot Kit (without grate; *SN 59832 & up) Note: The Burnpot holds the UltraGrate, which is where the fire takes place.
- [12150800](#) Burnpot w/ Gasket (4-1/2" long tube; use with grate #12150700; *SN 7217 - 59831)
- [12140102](#) Clip Kit, Firebrick (WP2) - 2 clips w/ fasteners
- [12146500](#) Firebrick Set (brick pattern; all 3 panels)
- [61057206](#) Gasket, Burnpot "O"-ring (WP2; 1-1/4" x 2.5") - 12 per pkg.
- [12150700](#) Grate (use with burnpot #12150800; *SN 7217 - 43377)
- [12150002](#) Log Set, Oak Ceramic
- [12151264](#) UltraGrate w/Base, 10 Rod, Retrofit Kit (*SN 1001 & up) - Note: This replaces the 14 bar grate, 12150812
- [12051263](#) UltraGrate, 10 Rod (Replacement grate only for 12151264)
- [17100061](#) Baffle, Heat Exchange

* SN - Stove serial number range, parts are compatible with:

">" = greater than # indicated, "<" = less than # indicated, "-" = numbers within range.

Advantage II-T Classic Whitfield Pellet

Advantage II-T Classic Pellet, Freestanding & Insert, WP2 MODEL YEARS: 2002 + (Serial # 122,301 & up)

(click the link for parts and ordering)

PART #	DESCRIPTION
Door Parts	
12140510	Bracket, Door Hinge
12151505	Bracket Kit, Window Wash
12150500	Door Assembly, Complete, Advantage II-T Classic- Black (3 pc)
61057100	Gasket Kit, Door Rope (WP2/WP4; 1/2" round; 7 ft.; firm)
61057201	Gasket Kit, Glass (WP2; 10 feet; 5/8", black with adhesive)
12146400	Glass, Center (13" x 9") (with gasket)
12146401	Glass, Side (4.3" x 9") (with gasket)
12054200	Handle Kit, Oak Door (WP2/WP4) - 2 per pkg.
12150507	Hinge Pin, Door (WP2/WP3; 5/16" x 1-1/2") - 2 per pkg.
12054500	Latch Kit, Door (with Oak Handle) - Black
12140102	Retainer, Brick (Right and Left)
12145200	Trim, Brass Center Glass
12151505	Window Wash Kit
Body Components	
12055205	Clip for Brass Glass Trim - 12 per pkg.
12145200	Trim Kit, Brass (for Center Glass)
12145202	Trim Kit, Brass (For Side Glass, left and right side)
12155000	Trivet, WP2 - Black Painted
12252003	Advantage II-T Pedestal
Electrical Parts	
12156009	Blower, Exhaust (Teardown, Complete)
52L02	Blower, Room Air
12055912	Control Board Kit
12147705	Disc, High Limit (Bakolite, L250-30F; 60T21) - 3 per pkg.
12057601	Disc, Low Limit (Ceramic F140-30F) - 3 per pkg.
12155908	Fuse, Control Board (3.5 amp, Fast blow, 250 vac, 12 per pkg.)
12055908	Fuse, Igniter (6 amp, Fast blow, 12 per pkg.)
12155907	Fuse, In-Line Holder With Fuse
12056003	Hose, Pressure Switch, WP2 (orange; silicone; 1/4" dia. X 4.5") - 3 per pkg.
12140213	Igniter Cartridge (probe, 400W)
12040003	Igniter Cartridge, 6 pack
12046300	Auger, Motor (Drives pellet feed auger)
12058820	Power Cord with Molded End, Detachable (8 ft.; 52L17)
12145903	Pressure Switch Kit (FS6460-910; red label; shuts off auger if exhaust becomes blocked)
16050205	Thermostat, Wall, Honeywell
12158811	Wiring Harness, WP2

Advantage II-T Classic Whitfield Pellet

(click the link for parts and ordering)

Auger System Components

- [12152202](#) Auger Kit (auger and set collar/screw)
- [12041300](#) Collar, Auger (includes set screw)
- [61050003](#) Gasket, Auger End Plate (Neoprene) - 5 per pkg.
- [20950088](#) Plate, Auger End (w/nylatron bushing)

Ash Pan Door, Ash Trap Baffles & Related Parts

- [12156500](#) Ash Pan
- [12157600](#) Door Assembly, Ash Pan - Black
- [61057204](#) Gasket Kit, Ash Pan (3/8" x 1/8" x 10')
- [12055500](#) Scraper Tool, Ash Pan/Grate
- [12150606](#) Trim, Ash Pan with Magnets - Black

Freestanding Only Parts

- [12251405](#) Lid with Hinge, Hopper (Freestanding) - Black
- [12254000](#) Panel, EZ Open, Left Side - Black
- [12256000](#) Panel, EZ Open, Right Side - Black
- [12255001](#) Panel, Top, F|S, Black
- [12252900](#) Trim Kit, Brass (for Side Panel, WP2 - Freestanding) - 3 per pkg.

Insert Only Parts

- [12351405](#) Lid with Hinge, Hopper (Insert) - Black
- [12354000](#) Panel, EZ Open, Left Side (Insert) - Black
- [12355000](#) Panel, EZ Open, Right Side (Insert) - Black
- [12351401](#) Panel, Top Front - Black
- [12352901](#) Trim Kit, Brass (for Side Panel - Insert) - 2 per pkg.

Miscellaneous Parts

- [12150003](#) Accessory Package
- [12141920](#) Baffle Kit, Ash Trap (Left and Right)
- [12050039](#) Casting, Aluminum Exhaust
- [12050039](#) Casting, Aluminum Exhaust Transduct
- [12151307](#) Collar, Damper Rod
- [61050003](#) Gasket, Auger End Plate - (5 per pkg.)
- [61057210](#) Gasket, Exhaust Blower Mounting (1/8" lytherm) - 5 per pkg.
- [61057203](#) Gasket, Room Air Blower, 5 per pkg. (neoprene rubber gasket)
- [12154201](#) Handle, Damper (3 per pkg.)
- [12151308](#) Plate Kit, Damper (use with 12151306 Damper Rod Kit)
- [12151306](#) Rod Kit, Damper (1/4" rod; includes Allen wrench)
- [12100906](#) Rod, Heat Exchange Scraper
- [12120011](#) Video

Firebox Parts

- [12146500](#) Firebrick Set (brick pattern; all 3 panels)
- [12051263](#) UltraGrate®, 10 Rod

Advantage II-T Classic Whitfield Pellet

Pellet

Advantage II-T Classic

Whitfield

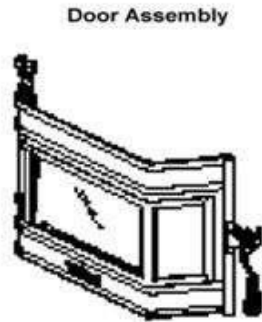
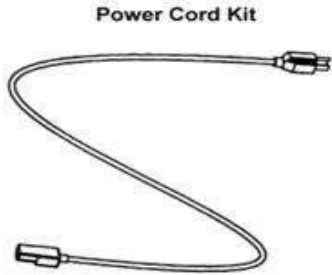
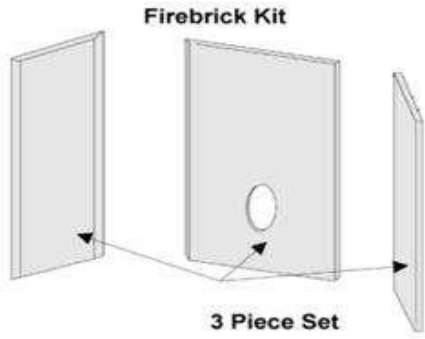

Glass
(Order each pc. separately. Gasket Included)

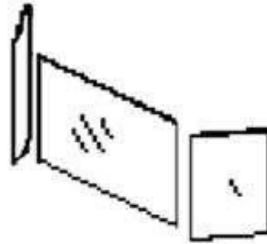

Advantage II-T Classic Whitfield Pellet

Pellet

Advantage II-T Classic

Whitfield

**Pressure Switch Kit
(hose not included)**



Control Board

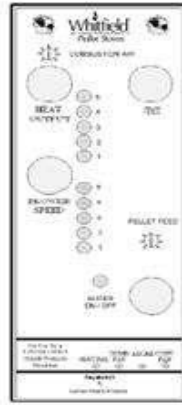

Auger Motor

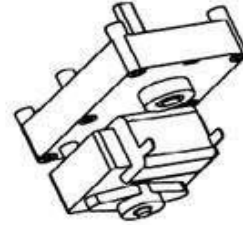

Auger Set Collar

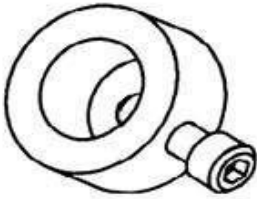

Damper Rod



Room Air Blower

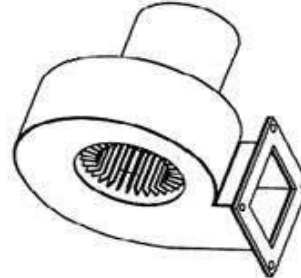

Auger End Plate Gasket

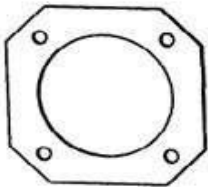

Exhaust Blower



**Advantage Optima 2 FS, Whitfield Pellet
Optima 3 FS, Optima 3 INS**

**Models Advantage Optima 2 FS, Optima 3 FS & Optima 3 INS
Freestanding and Insert Pellet Stoves**

MODEL YEARS: 2002 - present

DESCRIPTION Stove Model

(click the link for parts and ordering)

Door Parts & Body Components

14650414	Ash Pan Cover Optima 2 FS
14750460	Ash Pan Cover Optima 3 FS
14750605	Ash Pan Cover Optima 3 INS
14650460	(*2) Door Assembly, Cast Iron Firebox Optima 2 FS
14750458	(*2) Door Assembly, Cast Iron Firebox Optima 3 FS & INS
26M81	Gasket Kit, Door, 3/4" Rope, (10 Ft.) Optima 2 FS
61051000	Gasket Kit, Door, 1" Rope, (7 Ft.) Optima 3 FS & INS
61057202	Gasket Kit, Glass (5/8" x 1/16" x 10 Ft.) All
H0257	Glass, Front, Includes gasket Optima 2 FS
H0258	Glass, Side (order 2 if set is needed), Includes gasket Optima 2 FS
H0254	Glass, Front, Includes gasket Optima 3 FS & INS
H0255	Glass, Side (order 2 if set is needed) Includes gasket Optima 3 FS & INS
14650446	(*5) Hinge Bracket Optima 2 FS
14750700	(*6) Hinge Bracket Optima 3 FS & INS
13740005	Hopper Lid Hinge Brackets Optima 2 FS & 3 FS
11950068	Hopper Lid Hinge Brackets Optima 3 INS
14750406	(*3) Knob Kit, Door (includes latch, 3 washers, nut and door latch receiver) All
14750405	(*4) Opener, Door Handle All
14650450	(*7) Panel, Left Side Optima 2 FS
14650451	(*8) Panel, Right Side Optima 2 FS
14750449	(*9) Panel, Left Side Optima 3 FS
14750448	(*10) Panel, Right Side Optima 3 FS
14650456	(*11) Panel, Rear Optima 2 FS
14750465	(*12) Panel, Rear Optima 3 FS
14750612	(*13) Panel, Left Side Optima 3 INS
14750613	(*14) Panel, Right Side Optima 3 INS
14750617	(*15) Panel, Top (hopper lid) Optima 3 INS
14650455	(*16) Panel, Top (hopper lid) Optima 2 FS
14750455	(*16) Panel, Top (hopper lid) Optima 3 FS
12051409	Knob, Control Panel Door (6 per package w/studs) Optima 3 INS

Electrical Parts

12046300	(*17) Auger Motor All
12146109	(*28) Blower, Convection, Hard Washer (Includes gasket and four nuts) All
12050011	(*27) Blower, Exhaust All
16053941	(*18) Control Board Optima 2 FS
16052112	(*18) Control Board Optima 3 FS & INS
12147705	(*19) Disc, High Limit, 250 DG (L250-30F,60T21) Set of 3 All

**Advantage Optima 2 FS, Whitfield Pellet
Optima 3 FS, Optima 3 INS**

(click the link for parts and ordering)

[18150150](#) Fuse, Control Board, 5 Amp, 250 volt, Fast blow, 12 pk. All
[12055908](#) Fuse, Igniter, 6 Amp, 125 volt, Fast blow, 12 pk. All
[12140213](#) (*20) Igniter Probe, 400 W , 4.8 A All
[14750404](#) (*22) Photoeye Kit, Replacement All
[12058820](#) (*23) Power Cord, 8 feet All
[16050001](#) (*25) Pressure Switch All
[16050205](#) (*24) Thermostat, Wall All
[12050815](#) (*26) Wiring Harness All

Firebox Parts

[13640028](#) (*29) Clips, Brick Optima 2 FS
[11750011](#) (*30) Clips, Brick Optima 3 FS & INS
[14750469](#) Firebox Baffle Optima 3 FS & INS
[13650046](#) Firebox Baffle Optima 2 FS
[14650011](#) (*31) Firebrick Set, 1 pc. Optima 2 FS
[14750015](#) (*32) Firebrick Set, 3 pc. Optima 3 FS & INS
[14650428](#) (*33) Housing, Igniter Tube Optima 2 FS
[14750421](#) (*34) Housing, Igniter Tube Optima 3 FS & INS
[12158905](#) (*35) UltraGrate™ All

Auger System Components

[11756300](#) (*40) Auger Shaft All
[12051001](#) (*36) Bumper, Auger (Set of 5) All
[12041300](#) (*37) Collar & Screw Set, Auger (Set of 3) All
[20950088](#) (*38) Flange, Auger (end plate) All

Miscellaneous

[14650408](#) Ash Pan Optima 2 FS
[14750409](#) Ash Pan Optima 3 FS
[14750603](#) Ash Pan Optima 3 INS
[12151307](#) Collar, Damper Rod St, 1/4" (w/set screw) Optima 2 FS & 3 FS
[12151309](#) Damper Rod, Complete Optima 2 FS & 3 FS
[14750312](#) Damper Rod, Complete Optima 3 INS
[11750004](#) Damper Rod, Knob (6 per pack) All
[17150009](#) (*39) Rod Kit, Scraper (includes rod, collar and knob) All
[15050058](#) (*41) Filter, Photoeye All
[14650060](#) Gasket, Photoeye Optima 2 FS
[14750060](#) Gasket, Photoeye Optima 3 FS & INS
[61050003](#) (*42) Gasket, Auger Flange, 5pc. All
[61050005](#) (*43) Gasket, Exhaust blower, 5pc. All
[61057203](#) (*44) Gasket, Room air blower, 5pc. All
[61050016](#) (*45) Gasket, Quick Disconnect 5pc. All
[12055500](#) (*46) Tool, Grate Scraper All
[12050093](#) (*47) Quick Disconnect 3" Vent Side All
[16020011](#) Video, Advantage Optima All

**Advantage Optima 2 FS, Whitfield Pellet
Optima 3 FS, Optima 3 INS**

Pellet

Advantage Optima 2 FS,
Optima 3 FS, Optima 3 INS

Whitfield



**Advantage Optima 2 FS, Whitfield Pellet
Optima 3 FS, Optima 3 INS**

Pellet

Advantage Optima 2 FS,
Optima 3 FS, Optima 3 INS

Whitfield

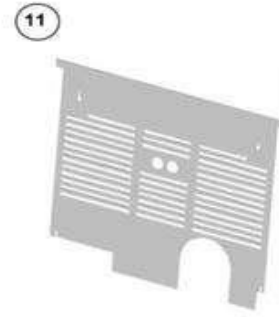
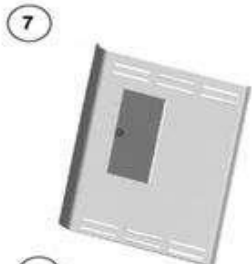
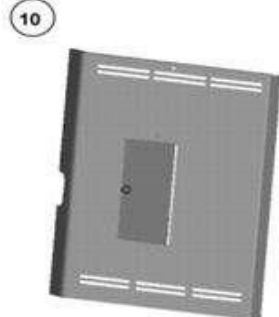
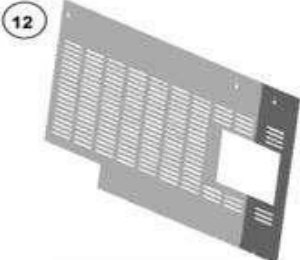

**Advantage Optima 2 FS, Whitfield Pellet
Optima 3 FS, Optima 3 INS**

Pellet

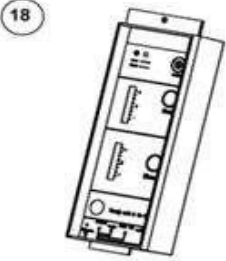
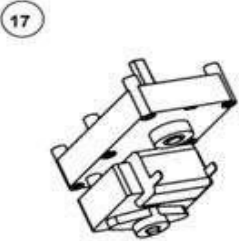

Advantage Optima 2 FS,
Optima 3 FS, Optima 3 INS

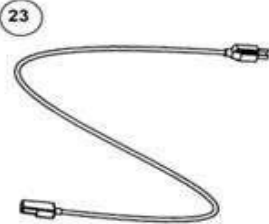
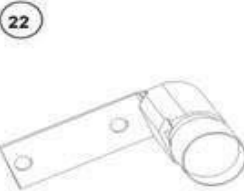
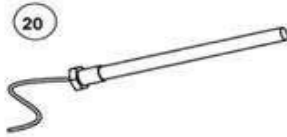

Whitfield

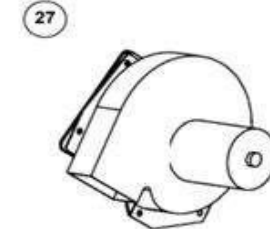
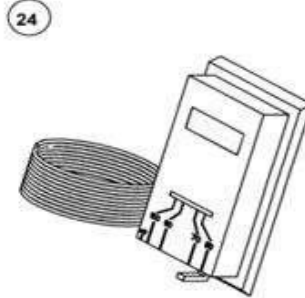

**Advantage Optima 2 FS, Whitfield Pellet
Optima 3 FS, Optima 3 INS**

Pellet

Advantage Optima 2 FS,
Optima 3 FS, Optima 3 INS

Whitfield

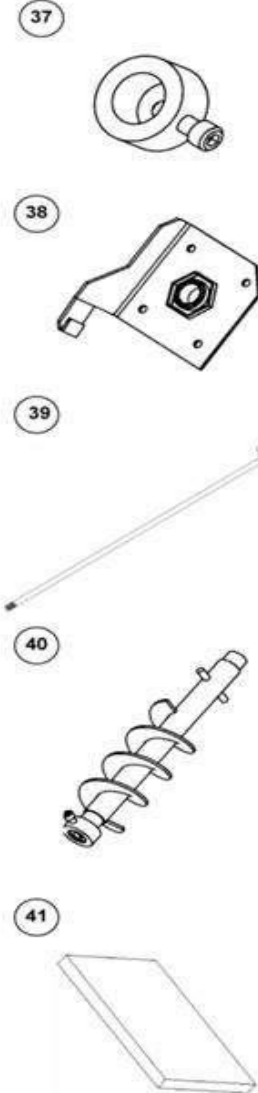
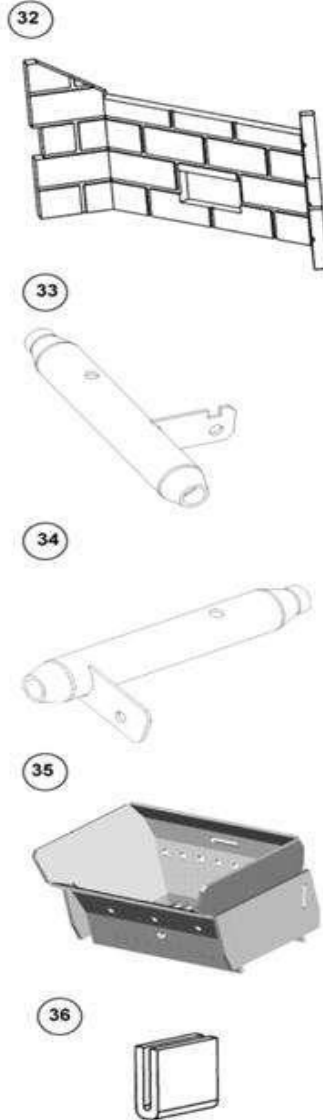
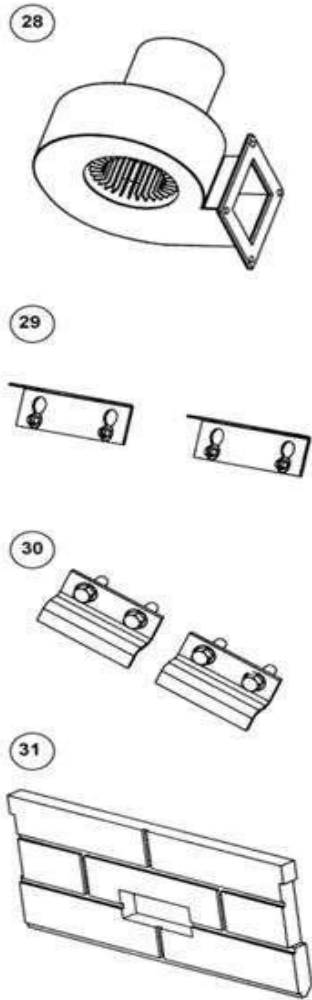

Advantage Plus FS Whitfield Pellet

**Advantage Plus FS
Pellet, Freestanding, WP7**

MODEL YEARS: 1996 - 2000

(click the link for parts and ordering)

PART #	DESCRIPTION
Door Parts	
18140046	Bracket, Hinge
11750100	Door Assembly (Black) Painted
11750300	Door Assembly (Brown) Painted
11750500	Door Assembly (Green) Painted
11750400	Door Assembly (Slate) Painted
61057100	Gasket Kit, Door (7' of 1/2" Firm)
61057208	Gasket Kit, Glass
12146402	Glass Kit, Door (Includes Gasket)
11750003	Handle, Gold Door
11750123	Hinge Pins, Gold
Body Components	
13740005	Bracket, Hopper Lid Support (F/S)
11850147	Panel, Side, LHS, (Black) Powder Coated
11850347	Panel, Side, LHS, (Brown) Powder Coated
11850547	Panel, Side, LHS, (Green) Powder Coated
11850447	Panel, Side, LHS, (Slate) Powder Coated
11850148	Panel, Side, RHS, (Black) Powder Coated
11850348	Panel, Side, RHS, (Brown) Powder Coated
11850548	Panel, Side, RHS, (Green) Powder Coated
11850448	Panel, Side, RHS, (Slate) Powder Coated
11850146	Panel, Top (Black) Powder Coated
11850346	Panel, Top (Brown) Powder Coated
11850546	Panel, Top (Green) Powder Coated
11850446	Panel, Top (Slate) Powder Coated
11855100	Pedestal w/ Ashpan (Black) Powder Coated
11855100PT	Pedestal w/ Ashpan (Blade) Painted
11855300	Pedestal w/ Ashpan (Brown) Powder Coated
11855500	Pedestal w/ Ashpan (Green) Powder Coated
11855400	Pedestal w/ Ashpan (Slate) Powder Coated
11851151	Trim, Bottom (Black) Painted
11853151	Trim, Bottom (Brown) Painted
11855151	Trim, Bottom (Green) Painted
11854151	Trim, Bottom (Slate) Painted
11850158	Trim, Brass (Set)

Advantage Plus FS Whitfield Pellet

(click the link for parts and ordering)

Electrical Parts

- [12046300](#) Auger Motor
- [12056010](#) Blower Kit, Exhaust (Motor & Housing)
- [12156009](#) Blower Kit, Exhaust (Teardown, Complete)
- [12146109](#) Blower, Room Air
- [12055902](#) Control Board
- [12147705](#) Disc, High Limit (L250-30F; 60T21) - 3 per pkg.
- [12057601](#) Disc, Low Limit (Ceramic,F140-30F; 49T style) - 3 per pkg.
- [61020015](#) Gasket, Exhaust Blower, Tear Down, 1 per pkg.
- [61057210](#) Gasket, Exhuast Blower Mounting (1/8" Lythern) - 5 per pkg.
- [61057203](#) Gasket, Room Air Blower - 5 per pkg.
- [13656003](#) Hose, Pressure Switch, 19" (may need to be cut to size) - 3 per pkg.
- [12140213](#) Igniter Probe (cartridge), Heater, WP2,4,7, 400W, 4.8A
- [12058820](#) Power Cord, Molded End
- [16050001](#) Pressure Switch
- [16050205](#) Thermostat, Wall, Honeywell (Thermostat Wire, P/N 16020204, is not included)

Auger System Components

- [11756300](#) Auger Shaft Kit
- [12041300](#) Collar, Damper Rod Set (Includes Screw) - 3 per pkg.
- [12153900](#) End Plate, Auger (w/ Nylatron Bushing)
- [61050003](#) Gasket, Auger End Plate - 5 per pkg.

Miscellaneous Parts

- [61040040](#) Gasket, 3" Quick Disconnect -10 per pkg.
- [12051500](#) Quick Disconnect, 3"
- [11751305](#) Rod, Damper
- [17150009](#) Rod, Scraper
- [12055500](#) Tool, Ash Pan / Grate Scraper
- [12021101](#) Bushing, Nylatron 1/2"
- [72023013](#) Nut, Hex (for Nylatron Bushing)

Firebox Parts

- [11750031](#) Baffle, Heat exchange
- [11750011](#) Clips, Brick
- [11750015](#) Firebrick Set
- [11750013](#) Firebrick-Rear Panel Only (Obsolete - limited quantities available)
- [11750001](#) Log Set, Oak (Obsolete - limited quantities available)
- [16050246](#) UltraGrate Replacement

Advantage Plus INS Whitfield Pellet

**Advantage Plus INS
Pellet, Insert, WP7**

MODEL YEARS: 1996 - 2000

(click the link for parts and ordering)

PART #	DESCRIPTION
18140046	Bracket, Hinge
11750100	Door Assembly (Black) Painted
11750300	Door Assembly (Brown) Painted
11750500	Door Assembly (Green) Painted
11750400	Door Assembly (Slate) Painted
61057100	Gasket Kit, Door (7' of 1/2" Firm)
61057208	Gasket Kit, Glass
12146402	Glass Kit, Door (Includes Gasket)
11750003	Handle, Gold Door
11750123	Hinge Pins, Gold
	Body Components
11951163	Ashpan, Lower, Black, Powder Coated
11953163	Ashpan, Lower, Brown, Powder Coated
11955163	Ashpan, Lower, Green, Powder Coated
11954163	Ashpan, Lower, Slate, Powder Coated
11950052	Ashpan, Upper, Black, Painted Only
11950068	Bracket, Hopper Lid Support (Insert Only)
11951167	Panel, Left Side, Black, Powder Coated
11953167	Panel, Left Side, Black, Powder Coated
11954167	Panel, Left Side, Black, Powder Coated
11955167	Panel, Left Side, Black, Powder Coated
11951168	Panel, Right Side, Black, Powder Coated
11953168	Panel, Right Side, Brown, Powder Coated
11955168	Panel, Right Side, Green, Powder Coated
11954168	Panel, Right Side, Slate, Powder Coated
11951166	Panel, Top, Black, Powder Coated
11953166	Panel, Top, Brown, Powder Coated
11955166	Panel, Top, Green, Powder Coated
11954166	Panel, Top, Slate, Powder Coated
11958121PT	Surround, Large, Black, Painted
11958120	Surround, Large, Black, Powder Coated
11958220	Surround, Large, Brown, Powder Coated
11958520	Surround, Large, Green, Powder Coated
11958420	Surround, Large, Slate, Powder Coated
11957121PT	Surround, Medium, Black, Painted
11957120	Surround, Medium, Black, Powder Coated
11957220	Surround, Medium, Brown, Powder Coated
11957520	Surround, Medium, Green, Powder Coated

Advantage Plus INS Whitfield Pellet**(click the link for parts and ordering)**

- [11957420](#) Surround, Medium, Slate, Powder Coated
- [11956121PT](#) Surround, Small, Black, Painted
- [11956120](#) Surround, Small, Black, Powder Coated
- [11956220](#) Surround, Small, Brown, Powder Coated
- [11956520](#) Surround, Small, Green, Powder Coated
- [11956420](#) Surround, Small, Slate, Powder Coated

Electrical Parts

- [12046300](#) Auger Motor
- [17100061](#) Baffle, Heat Exchange
- [12056010](#) Blower Kit, Exhaust (Motor & Housing)
- [12156009](#) Blower, Exhaust Kit (Teardown, Complete)
- [12147705](#) Disc, High Limit (L250-30F; 60T21) - 3 per pkg.
- [12057601](#) Disc, Low Limit (Ceramic, F140-30F, 49T style) - 3 per pkg.
- [61057210](#) Gasket, Exhaust Blower Mounting (1/8" Lythorn) - 5 per pkg.
- [61020015](#) Gasket, Exhaust Blower, Tear Down, 1 per pkg.
- [61057203](#) Gasket, Room Air Blower - 5 per pkg.
- [12058820](#) Power Cord, Molded End
- [16050001](#) Pressure Switch
- [13656003](#) Hose, Pressure Switch, 19" (may need to be cut to size) - 3 per pkg.
- [16050205](#) Thermostat, Wall, Honeywell (Thermostat Wire, P/N 16020204, is not included)
- [12158800](#) Wiring Harness

Auger System Components

- [11756300](#) Auger Shaft Kit
- [12041300](#) Collar, Damper Rod Set (Includes Screw) - 3 per pkg.
- [61050003](#) Gasket, Auger End Plate - 5 per pkg.
- [12153900](#) Plate, Auger End (w/ Nylatron Bushing)

Miscellaneous Parts

- [61040040](#) Gasket, 3" Quick Disconnect -10 per pkg.
- [12051500](#) Quick Disconnect, 3"
- [11751305](#) Rod, Damper
- [17150009](#) Rod, Scraper
- [12055500](#) Tool, Ash Pan / Grate Scraper
- [16020204](#) Wire, Thermostat, 20' coil - 18 gage
- [12021101](#) Bushing, Nylatron 1/2"
- [72023013](#) Nut, Hex (for Nylatron Bushing)

Firebox Parts

- [11750031](#) Baffle, Heat exchange
- [11750011](#) Clips, Brick
- [11750015](#) Firebrick Set
- [11750013](#) Firebrick-Rear Panel Only (Obsolete - limited quantities available)
- [11750001](#) Log Set, Oak (Obsolete - limited quantities available)
- [16050246](#) UltraGrate, Replacement

BBQ Pellet Grill (WP6) Whitfield Pellet

BBQ Pellet Grill (WP6) MODEL
YEARS: 1996 - 1997 ([click the link](#)
for parts and ordering)

PART #	DESCRIPTION
18190085	Auger Shaft Kit
18150047	Baffle, Flame
18150057	Baffle, Flame Stand, Short
18150051	Baffle, Flame Stand, Tall
18150007	Cap, Left Bottom End Š
18150004	Cap, Left Top End Š
18150006	Cap, Right Bottom End Š
18150008	Cap, Right Top End Š
18156200	Control, ACP #606
18158811	Cooking Grid, Wire Enamel (2 ea)
18150162	Disc, High Limit
18150150	Fuse, 6-amp (Pkg of 12)
18150005	Handle, Clamshell Top (2 each) Š
18150034	Housing, Hopper (Front) Š
18150076	Hub, Wheel, Black Hat Style (5 each) Š
18150050	Igniter w/o sleeve - new grill
18150000	Igniter w/sleeve - old grill
18150157	Knob, Controller
18156300	Motor, Auger
18150123	Motor, Exhaust Blower
18150175	Name Plate Š
18150090	Pin Kit, Hinge (2 sets per kit), includes T Bridge Pin
18158200	Power Cord, 10'
18158813	Rack, Lower Storage (2 each) Š
18150033	Rack, Warming Š
18158810	Rocker Switch w/Light
18150105	Shelf, Front Š
18150045	Shelves, Side (2 each) Š
18150170	Thermometer Š
18152201	Wiring Harness w/Fuse
	Šbsolute - limited quantity available

Cascade Whitfield Pellet

Cascade

Pellet, Freestanding, WP5

MODEL YEARS: 1995 - present

(click the link for parts and ordering)

PART

DESCRIPTION

Door Parts

17151220	Door Assembly, Brown Metallic
14M44	Door Assembly, Gold
17151210	Door Assembly, Painted, Metallic Black > S# 7422
17157100	Gasket Kit, Door and Glass
17150084	Glass, Door (Includes clips, screws and gasket)
17150086	Handle Assembly, Painted, Metallic Black
17151086	Handle Assembly, Painted, Metallic Brown

Body Components

17150046	Ashlip with Gold Tone Trim, Painted, Metallic Black
17150012	Ashlip, Painted, Metallic Brown
17152018	Ashpan Assembly, Black
17151018	Ashpan Assembly, Brown
17150030	Leg Set, Painted, Metallic Black
17151032	Leg Set, Painted, Metallic Brown
17150147	Louver Assembly, Painted, Metallic Black
17100161	Panel, Back, Metallic Black, Painted > S# 7422
17151117	Panel, Back, Brown, Golden Fire, Paint
17152118	Panel, Left Side, Black
17151118	Panel, Left Side, Brown, Golden Fire, Paint
17150163	Panel, Left, Painted, Metallic Black > S# 7422
17151119	Panel, Right Side, Brown, Golden Fire, Paint
17150164	Panel, Right Side, Painted, Metallic Black > S# 7422
17151116	Panel, Top, Brown, Golden Fire, Paint
17150150	Panel, Top, Painted, Metallic Black (Hopper lid) > S# 7422

Electrical Parts

12046300	Auger Motor (Helix)
17140110	Blower Kit, Exhaust & Room Air
17150027	Control Board
12150162	Disc, High Limit, Room Air Blower Jacket (L190-20F, Bakolite) Pkg. of 3
12150080	Disc, Low Limit, Fan (F140-10F, Bakolite), Pkg. of 3
12055908	Fuse, 6 Amp, Fast Acting, Pkg. of 12
61057210	Gasket, Exhaust Blower, 1/8" Lytherm (Pkg. of 5)
61057203	Gasket, Room Air Blower (Pkg. of 5)
12058820	Power Cord (52L17)
17150075	Pressure / Vacuum Switch (Hose, 12056003, not included)
12056003	Hose, Pressure Switch
17150126	Wiring Harness

Cascade Whitfield Pellet

(click the link for parts and ordering)

Auger System Components

- [17150239](#) Auger, Shaft
- [12051001](#) Bumper, Auger (Pkg. of 5)
- [12041300](#) Collar & Screw Set, Auger (Pkg. of 3)
- [17150058](#) Plate, Auger End
- [61050003](#) Gasket, Auger Flange

Miscellaneous Parts

- [12050004](#) Brush, Cleaning
- [12021101](#) Bushing, Nylatron
- [12051100](#) Bushing, Oilite
- [17150029](#) Damper Rod Assembly, Kit, Black (w/ handle)
- [17151029](#) Damper Rod Assembly, Kit, Brown
- [61040040](#) Gasket, 3" Quick Disconnect (Pkg. of 10)
- [12151412](#) Knob, Ashpan (Pkg. of 6)
- [17150028](#) Knob, Control Board (Slide), Set of 3
- [17100034](#) Plate, Ash Clean-Out, Left
- [17100035](#) Plate, Ash Clean-Out, Right
- [14M80](#) Quick Disconnect Kit
- [12055500](#) Tool, Grate Scraper

Firebox Parts

- [17100061](#) Baffle, Heat Exchange
- [17150025](#) Firebrick and Retainer Clips
- [16050246](#) UltraGrate, Replacement

Frontiersman (WF2) / Explorer (WF1) Whitfield Pellet

Frontiersman (WF2) / Explorer (WF1)

MODEL YEAR: 1989 - 1990 (Serial #1001 & Up)

(click the link for parts and ordering)

PART #

DESCRIPTION

Door Parts

- [12045105](#) Clip, Glass (bent) - pkg. of 2
- [12045100](#) Clip, Glass (flat/side) - pkg. of 2
- [12054200](#) Handle Kit, Oak, Door (WP2/WP4) - pkg. of 2

Electrical Parts

- [12056010](#) Blower, Exhaust (Motor & Housing)
- [12156009](#) Blower, Exhaust (Teardown, Complete. Includes low limit disc, 12057601, and gasket, 61057210)
- [22026300](#) Motor, Auger - WF
- [12050504](#) Potentiometer Kit, Feed Control (blue wires; replaces 6-second timer and potentiometer)
- [12050701](#) Switch, Momentary Start
- [12050702](#) Switch, On/Off
- [12040403](#) Timer, 1-second Recycling, SSAC

Miscellaneous Parts

- [73020304](#) Paint, Enamel, Metallic Gloss - Black (54-H-240)
- [73020305](#) Paint, Enamel, Metallic Gloss - Brown (54-H-840)
- [73020306](#) Paint, Enamel, Metallic Gloss - Slate (54-H-440)

Firebox Parts

- [22020302](#) Firebrick, Side Panel, WF (white) Obsolete - limited quantities available
- [24256500](#) Firebrick Set (cut to size)

Legend (WP1) Whitfield Pellet

Legend (WP1)

MODEL YEAR: 1984 - 1987 (Serial #1001 - 6177)

(click the link for parts and ordering)

PART #

DESCRIPTION

Door Parts

- [21054800](#) Clip Kit, Glass, WP1
- [21020003](#) Glass, Door, WP1 (6-1/2" x 9") Includes Gasket

Electrical Parts

- [12046300](#) Motor, Auger (Drives pellet feed auger)
- [12156009](#) Blower, Exhaust, Teardown, Complete (Includes low limit disc, 12057601, and gasket, 61057210)
- [21020301](#) Blower, Room Air, WPI (Dayton 4C443A)
- [12147705](#) Disc, High Limit (L250-30F; 60T21, Bakolite) - pkg. of 3
- [12057601](#) Disc, Low Limit, Ceramic (F140-30F; 49T style) - pkg. of 3
- [12056010](#) Blower, Exhaust (Motor & Housing)
- [12056108](#) Impeller, Exhaust Blower
- [12050504](#) Potentiometer Kit, Feed Control (blue/yellow wires; replaces 6-second timer and potentiometer)
- [12058200](#) Power Cord w/Cable Connectors (8 ft.)
- [12050701](#) Switch, Momentary Start
- [12050702](#) Switch, On/Off
- [21040407](#) Timer Kit, RK, WP1 (replaces OMRON and Dayton timers)
- [12040403](#) Timer, 1-second Recycling, SSAC
- [24220405](#) Timer, 30 minute, ACP (note: If both timers need replacing use kit 21040407)
- [12040404](#) Timer, 30-minute, SSAC

Auger System Components

- [12051100](#) Auger Bushing, Oilite - pkg. of 12
- [61050003](#) Auger End Plate Gasket, Neoprene - pkg. of 5
- [12153900](#) Auger End Plate w/Oilite Bushing, WP2
- [12152202](#) Auger Kit (auger and set collar/screw)
- [12046300](#) Auger Motor (Drives pellet feed auger)
- [12041300](#) Auger Set Collar/Screw - Pkg. of 3

Firebox Parts

- [21050800](#) Burnpot, WP1 (to be used with #21000705) Note: The Burnpot holds the Burn Grate, which is where the fire takes place.
- [21020101](#) Firebrick, Back Panel, WP1 (white)
- [21020102](#) Firebrick, Side Panel, WP1 (white)
- [21050705](#) Grate, Drop-In, Stainless Steel, WP1
- [21050700](#) Grate, Flat, WP1 (1984-86 models without separate burnpot & grate)
- [24256500](#) Firebrick Set (cut to size)

Prodigy I II Whitfield Pellet

Prodigy I & II WP3

Pellet, Freestanding, WP3

MODEL YEARS: 1990 - 1994 (Serial # 1001 & up)

(click the link for parts and ordering)

PART

DESCRIPTION

Door Parts

72045001	Shoulder Bolt Kit, Door Latch Boss
61057101	Gasket Kit, Door, WP3/WW1 (3/8", medium, black rope)
13546400	Glass, Center, (8-9/16" x 9-7/8")
13546401	Glass, Side, (3-1/4" x 8-9/16")
12054200	Handle, Door, Oak - 2 per pkg.
12150507	Hinge Pin, Door (WP2/WP3; 5/16" x 1-1/2") - 2 per pkg.
72045000	Shoulder Bolt Kit, Door Latch

Body Components

13553600	Ash Pan Kit
12055205	Clip for Brass Glass Trim - 12 per pkg.
13525200	Trim, Brass (for Center Glass)
13525202	Trim, Brass (for Side Glass)

Electrical Parts

13556214	Blade, Exhaust Blower Motor Cooling Fan (Outside; 5/16" hub for C-Frame motor)
13546210	Blower Motor, Exhaust (C-Frame, Booster, Neg. Pressure Extracts Exhaust to Vent) w/ Cooling Fan Blade (*SN 2282 & up)
13046109	Blower, Hall Effect Room Air and Exhaust (use with SSAC control board; *SN 2282 & up. Functions as Neg. Press Comb. Air (push) into firebox and Room Air Blower.
12146109	Blower, Room Air (*SN 1001 - 2281)
13045900	Control Board, WW1/WP3 (ICM brand or equivalent; *SN 1001 - 2281) Obsolete - Limited quantities available.
13057801	Disc, High Limit (250 Degrees F.; 36T style) - 4 per pkg.
12057601	Disc, Low Limit (Ceramic, F140-30F; 49T style) - 3 per pkg.
13556212	Impeller, Exhaust Blower Motor (Exhaust; 1/4" blade - orig. equip.)
12051400	Knob, Control Board Heat Output - 2 per pkg.
13050002	Microswitch Kit, (*SN 2283 & up) Set of 3
12046300	Motor, Auger Motor (Drives pellet feed auger)
13025903	Pressure Switch Kit (FS6569-1018; B.P. @ +.10 in. W.C.; blue label)
13656003	Hose, Pressure Switch, 19" (may need to be cut to size) - 3 per pkg.
12058200	Power Cord
12055907	Fuse, 2.5 Amp (Ser. #1001-2282)
12055908	Fuse, 6 Amp (Ser. #2283-Up)
13545903	Relay, Exhaust Blower Motor
13045909	Relay, Latch-out (*SN 1001 - 2281)
13020003	Spring, Microswitch Actuation, WW1/WP3 (conical)
16050205	Thermostat, Wall, Honeywell (Wire, 16020204, not included)
16020204	Wire, Thermostat, 20' coil - 18 gage

Prodigy II Whitfield Pellet

(click the link for parts and ordering)

Auger System Parts

- [13052100](#) Auger Shaft Kit
- [12051100](#) Bushing, Auger (Oilite) - 12 per pkg.
- [61050003](#) Gasket, Auger End Plate (Neoprene) - 5 per pkg.
- [13052000](#) Plate, Auger End, WW1/WP3

Miscellaneous Parts

- [61020002](#) Gasket, Exhaust Connector
- [61020001](#) Gasket, Exhaust Duct Plug (round, lytherm)
- [13522404](#) Grommet, Bottom Plate (3/4" O.D. x 5/16" I.D.)
- [73020303](#) Paint, 12 oz. Spray - Goldenfire Brown (6230)
- [13540001](#) U-Tube Removal Kit, Secondary Air - 1992, Prodigy WP3 S# 1001-3786, Suggestion: WP3-II Models Only - Serial Numbers 2283 through 3517 - It is recommended, but not necessary, that the Optional Booster Motor Upgrade Kit (PN 13546210) also be installed.
- [12041300](#) Set Collar w/Set Screw
- [14000906](#) Scraper Rod, 1/4" diameter, Tube (bent) **
- [14020906](#) Scraper Rod, 3/16" diameter, Tube (bent) **

Firebox Parts

- [13053200](#) Burnpot Note: The Burnpot holds the Burn Grate, which is where the fire takes place.
- [13053100](#) Burnpot/Grate Kit, WW1/WP3 Note: The Burnpot holds the Burn Grate, which is where the fire takes
- [13046500](#) Firebrick Kit (ceramic fiber board and clips)
- [61057207](#) Gasket, Burnpot/Secondary Air Tube "O"-ring (WW1/WP3) - 12 per pkg.
- [13053500](#) Grate (*SN 1001 & up)

* SN - Stove serial number range, parts are compatible with:

">" = greater than # indicated, "<" = less than # indicated, "-" = numbers within range.

** Measure the diameter of the original scraper rod to determine which kit is needed.

Profile 20 FS Whitfield Pellet

**(< Serial # 7494) Profile 20 FS and Profile 20 FS-2 (> Serial #7495)
Pellet, Freestanding, P9**

MODEL YEARS: 2000 - 2002

(click the link for parts and ordering)

PART #	DESCRIPTION
	Door Parts
13640075	Clip Kit, Glass Bottom
13640086	Clip Kit, Glass Right + Left Side
13640085	Clip Kit, Glass Top
14650006	(*1) Door Assembly, Firebox (with 3 Piece Glass)
61057202	Gasket Kit, Glass, 10 ft.
26M81	Gasket, Door, 3/4" Rope, 8 ft.
H0257	Glass, Center Š
H0258	Glass, Side (Order 2 if set is needed. Gasket included) Š
17250095	(*3) Handle Assembly, Door
14650047	(*5) Hinge Bracket
	Body Components
14650003	(*7) Panel, Left Side
14650048	(*11) Panel, Rear
14650004	(*8) Panel, Right Side
14650012	(*16) Panel, Top
14695000	Pedestal, Profile 20
	Electrical Parts
12046300	(*18) Auger Motor
12050011	(*43) Blower, Exhaust
12146109	(*44) Blower, Room Air, Hard Washer *
16053941	(*19) Control Board
12147705	(*20) Disc, High Limit, 250 DG (L250-30F,60T21) - 3 per pkg.
18150150	Fuse, Control Board, 5 Amp, 250 volt, Fast blow, 12 per pkg.
12055908	Fuse, Igniter, 6 Amp, 125 volt, Fast blow, 12pk.
13656003	Hose, Pressure Switch, 19" (may need to be cut to size) - 3 per pkg.
12140213	(*21) Igniter Probe, 400 W , 4.8 A
14750404	(*22) Photoeye Kit, Replacement (w/bracket) - Serial #7495 and up (units with Serial # lower than #7495 order Kit P/N H0351 (relocates Photoeye to top of auger tube at hopper)
H0351	Photoeye relocation kit Serial # <7495 (relocates photoeye to top of auger tube)
12058820	(*24) Power Cord, 8 feet (52L17)
16050001	(*26) Pressure Switch
16050205	(*25) Thermostat, W all, Honeywell (Thermostat Wire, P/N 16020204, is not included)
16020204	Wire, Thermostat, 20' coil - 18 gage
12050815	(*27) Wiring Harness

Profile 20 FS Whitfield Pellet

(click the link for parts and ordering)

Auger System Components

- [11756300](#) (*37) Auger Shaft Kit
- [12051001](#) (*34) Bumper, Auger (5 per pkg.)
- [12041300](#) (*35) Collar & Screw Set, Auger (3 per pkg.)
- [20950088](#) (*36) Plate, Auger End (Flange)

Miscellaneous Parts

- [11950068](#) Bracket, Hopper Lid Support
- [12021101](#) Bushing, Nylatron 1/2"
- [20M97](#) Enhancement Kit (includes pressure switch and auger bumper)
- [61050003](#) (*39) Gasket, Auger Flange, 5 per pkg..
- [61050005](#) (*40) Gasket, Exhaust Blower, Fan Mount, 5 per pkg.
- [61050041](#) Gasket, Exhaust Blower, Tear Down, 5 per pkg.
- [61050016](#) (*42) Gasket, Quick Disconnect 5 per pkg..
- [61057203](#) (*41) Gasket, Room Air Blower, 5 per pkg..
- [12151306](#) Handle, Damper (1/4" Rod and Allen Wrench)
- [11720004](#) Knob, Damper
- [12051409](#) Knob, Door (6 per pkg.)
- [70K99](#) Paint, Metallic Black (12 oz Spray # 6309)
- [H0262](#) Plug, Feed Tube Slot Cover - Prevents excess pellet dust from becoming airborne for units with additional slot on opposite side of photoeye slot in feed tube (facing unit, the plug covers the slot on the right side of feed tube (units prior to 12/2001)
- [14M81](#) Quick Disconnect 4" (QDPC - 4)
- [12050093](#) (*46) Quick Disconnect 3"
- [14750014](#) Scraper Rod Kit, Replacement (Fits - Profile Series, Freestanding & Insert)
- [12055500](#) (*45) Tool, Grate Scraper

Firebox Parts

- [13650046](#) Baffle, Heat Exchange
- [13640028](#) (*29) Clips, Brick
- [14650011](#) (*31) Firebrick Set
- [H0244](#) Log Set, DLS-P20
- [12051263](#) (*33) UltraGrate, Replacement
Includes gasket.

* Includes gasket and four nuts.

See Component Diagrams on pages P37 - P39

Profile 30 FS Whitfield Pellet
(< Serial #11904) Profile 30 FS and Profile 30 FS-2 (> Serial #11905)
Pellet, Freestanding, P10
MODEL YEARS: 2000 - 2002

(click the link for parts and ordering)

PART #

DESCRIPTION

Door Parts

- [14750027](#) Clip Kit, Glass Bottom (Doors w/ 1pc glass)
- [14750264](#) Clip Kit, Glass Top Bottom (Doors w/ 3pc glass)
- [14750111](#) Door Assembly, Firebox, (with 1 Piece Glass)
- [H0297](#) (*2) Door Assembly, Firebox, DK-P30 (with 3 Piece Glass) *SN > 14708999
- [26M81](#) Gasket Kit, Door, ¾" Rope, 8 ft. (units with 1 piece glass)
- [61051000](#) Gasket Kit, Door, 1" Rope, 7 ft. (units with 3 piece glass)
- [61057202](#) Gasket Kit, Glass (10 Ft.)
- [12146402](#) Glass, Front (units with 1 pc. glass) Š
- [H0254](#) Glass, Front (units with 3 pc. glass) Š
- [H0255](#) Glass, Side (order 2 if set is needed) (units with 3 pc. glass) Š
- [17150095](#) (*4) Handle Assembly, Door
- [14750021](#) (*6) Hinge Bracket

Body Components

- [14750070](#) (*9) Panel, Left Side
- [14750150](#) (*12) Panel, Rear
- [14750075](#) (*10) Panel, Right Side
- [14750060](#) (*16) Panel, Top
- [14750186](#) (*17) Pedestal Assembly

Electrical Parts

- [12050011](#) (*43) Blower, Exhaust
- [12146109](#) (*44) Blower, Room Air (Hard Washer) Includes gasket and four nuts.
- [16052112](#) (*19) Control Board
- [12147705](#) (*20) Disc, High Limit, 250 DG (L250-30F,60T21) 3 per pkg.
- [18150150](#) Fuse, Control Board, 5 Amp, 250 volt, Fast blow, 12 per pkg.
- [12055908](#) Fuse, Igniter, 6 Amp, 125 volt, Fast blow, 12 per pkg.
- [61050041](#) Gasket, Exhaust Blower, Tear Down, 5 per pkg.
- [61050005](#) (*40) Gasket, Exhaust Fan, Fan Mount, 5 per pkg.
- [61057203](#) (*41) Gasket, Room Air Fan, 5 per pkg.
- [12140213](#) (*21) Igniter Probe, 400 W, 4.8 A
- [12046300](#) (*18) Motor, Auger
- [14750404](#) (*22) Photoeye Kit, Replacement (w/bracket) - Serial #11905 and up (units with Serial # lower than #11905 order Kit P/N H0330 (relocates Photoeye to top of auger tube at hopper)
- [H0330](#) Photoeye relocation kit Serial # <11905 (relocates photoeye to top of auger tube)
- [12058820](#) (*24) Power Cord, 8 feet (52L17)
- [16050001](#) (*26) Pressure Switch
- [13656003](#) Hose, Pressure Switch, 19" (may need to be cut to size) - 3 per pkg.
- [13050002](#) (*28) Switch, Door (3 per pkg.; 52L20)
- [16050205](#) (*25) Thermostat, Wall (Wire, 16020204, not included)
- [12050815](#) (*27) Wire Harness
- [16020204](#) Wire, Thermostat, 20' coil - 18 gage

Profile 30 FS Whitfield Pellet

(click the link for parts and ordering)

Auger System Components

- [11756300](#) (*37) Auger Shaft Kit
- [12051001](#) (*34) Bumper, Auger, 5 per pkg.
- [12041300](#) (*35) Collar & Screw Set, Auger, 5 per pkg.
- [17250241](#) (*36) End Plate, Auger (Flange)

Miscellaneous Parts

- [13740005](#) Bracket, Hopper Lid Support
- [12050004](#) (*38) Brush, Cleaning
- [12021101](#) Bushing Nylatron 1/2"
- [12151306](#) Damper Rod Kit
- [20M96](#) Enhancement Kit, Profile 30FS - includes Pressure Switch, Control Board, Auger Bumper, Ash Slide and Cleaning Brush
- [21M87](#) Enhancement Kit, Profile 30INS - includes Pressure Switch, Control Board, Auger Bumper
- [61050016](#) (*42) Gasket, Quick Disconnect, 5 per pkg.
- [61050003](#) (*39) Gasket, Auger Flange, 5 per pkg.
- [12051409](#) Knob, Control Board Door (6 per pkg.)
- [11720004](#) Knob, Damper
- [72023013](#) Nut, Hex (for Nylatron Bushing)
- [70K99](#) Paint Kit, Metallic Black (12 oz Spray #6309)
- [17100034](#) Plate, Ash Clean-Out, Left
- [17100035](#) Plate, Ash Clean-Out, Right
- [12050093](#) Quick Disconnect 3"
- [14M81](#) Quick Disconnect 4" (QDPC - 4)
- [12050093](#) (*46) Quick Disconnect, 3"
- [14750014](#) Scraper Rod Kit, Replacement (Fits - Profile Series, Freestanding & Insert)
- [12055500](#) (*45) Tool, Grate Scraper

Firebox Parts

- [17100061](#) Baffle, Heat Exchange
- [11750011](#) (*30) Clips, Brick
- [14750015](#) (*32) Firebrick Set
- [H0245](#) Log Set, DLS-P30
- [12051263](#) (*33) UltraGrate, Replacement

* SN - Stove serial number range, parts are compatible with:

">" = greater than # indicated, "<" = less than # indicated, "-" = numbers within range.

Includes gasket.

See Component Diagrams on pages P37 - P39

Profile 30 INS Whitfield Pellet

(< Serial #11904) Profile 30 INS and Profile 30 INS-2 (> Serial #11905)

Pellet, Insert

MODEL YEARS: 2000 - 2002

(click the link for parts and ordering)

PART #

DESCRIPTION

Door Parts

- [14750027](#) Clip Kit, Glass Bottom(w/ 1pc glass)
- [14750264](#) Clip Kit, Glass Top/Bottom (w/ 3pc glass)
- [14750111](#) Door Assembly, Firebox, (with 1 Piece Glass)
- [H0297](#) (*2) Door Assembly, Firebox, DK-P30 (with 3 Piece Glass) *SN > 14708999
- [61057202](#) Gasket Kit, Glass (10 Ft.)
- [26M81](#) Gasket, Door, ¾" Rope, 10 ft. (units with 1 piece glass)
- [61051000](#) Gasket, Door, 1" Rope, 7 ft. (units with 3 piece glass)
- [12146402](#) Glass, Front (units with 1 pc. glass) Š
- [H0254](#) Glass, Front (units with 3 pc. glass) Š
- [H0255](#) Glass, Side (order 2 if set is needed) (units with 3 pc. glass) Š
- [17150095](#) (*4) Handle Assembly, Door
- [14750021](#) (*6) Hinge Bracket

Body Components

- [14750340](#) (*13) Panel, Left Side
- [14750345](#) (*14) Panel, Right Side
- [14750300](#) (*15) Panel, Top

Electrical Parts

- [12046300](#) (*18) Auger Motor
- [12050011](#) (*43) Blower, Exhaust
- [12146109](#) (*44) Blower, Room Air, Hard Washer (Includes gasket and four nuts)
- [16052112](#) (*19) Control Board
- [12147705](#) (*20) Disc, High Limit, 250 DG (L250-30F,60T21) - 3 per pkg.
- [18150150](#) Fuse, Control Board, 5 Amp, 250 volt, Fast blow - 12 per pkg.
- [12055908](#) Fuse, Igniter, 6 Amp, 125 volt, Fast blow, 12pk.
- [13656003](#) Hose, Pressure Switch, 19" (may need to be cut to size) - 3 per pkg.
- [12140213](#) (*21) Igniter Probe, 400 W, 4.8 A
- [14750404](#) (*22) Photoeye Kit, Replacement (w/bracket) - Serial #11905 and up (units with Serial # lower than Photoeye relocation kit Serial # <11905 (relocates photoeye to top of auger tube)
- [H0330](#) (*24) Power Cord, 8 feet (52L17)
- [12058820](#) (*26) Pressure Switch
- [16050001](#) (*28) Switch, Door (52L20) - 3 per pkg.
- [13050002](#) (*25) Thermostat, Wall (Wire, 16020204, not included)
- [16050205](#) (*27) Wire Harness
- [12050815](#) Wire, Thermostat, 20' coil - 18 gage
- [16020204](#)

Auger System Components

- [12051001](#) (*34) Bumper, Auger (5 per pkg.)
- [12041300](#) (*35) Collar & Screw Set, Auger (3 per pkg.)
- [17250241](#) (*36) Flange, Auger
- [61050003](#) (*39) Gasket, Auger Flange, 5 per pkg.
- [11756300](#) (*37) Shaft, Auger

Profile 30 INS Whitfield Pellet

(click the link for parts and ordering)

Miscellaneous Parts

- [14790031](#) Accessory Package (Power Cord, Grate Scraper, Lower Trim, Thermostat Wire, Wall Thermostat, Bottle Brush, Manual and Warranty)
- [11950068](#) Bracket, Hopper Lid Support
- [12050004](#) (*38) Brush, Cleaning
- [12021101](#) Bushing Nylatron 1/2"
- [61050016](#) (*42) Gasket, Quick Disconnect
- [61050005](#) (*40) Gasket, Exhaust Blower, Fan Mount, 5 per pkg.
- [61050041](#) Gasket, Exhaust Blower, Tear Down, 5 per pkg.
- [61057203](#) Gasket, Room Air Blower, 5 per pkg.
- [12051409](#) Knob, Control Panel Door (w/studs) 6 per pkg.
- [11720004](#) Knob, Damper
- [72023013](#) Nut, Hex (for Nylatron Bushing)
- [70K99](#) Paint, Metallic Black (12 oz Spray # 6309)
- [17100034](#) Plate, Ash Clean-Out, Left
- [17100035](#) Plate, Ash Clean-Out, Right
- [12050093](#) (*46) Quick Disconnect 3" Vent Side
- [14M81](#) Quick Disconnect 4" (QDPC - 4)
- [14750014](#) Scraper Rod Kit, Replacement (Fits - Profile Series, Freestanding & Insert)
- [72051006](#) Stud, Plated (for Surround) 20 per pkg.
- [12055500](#) (*45) Tool, Grate Scraper

Firebox Parts

- [11750011](#) (*30) Clips, Brick
 - [14750015](#) (*32) Firebrick Set
 - [H0245](#) Log Set
 - [12051263](#) (*33) UltraGrate, Replacement
- * SN - Stove serial number range, parts are compatible with:
">" = greater than # indicated, "<" = less than # indicated, "-" = numbers within range.

Includes gasket.

See Component Diagrams on pages P37-P39

Profile Series Whitfield Pellet

Pellet

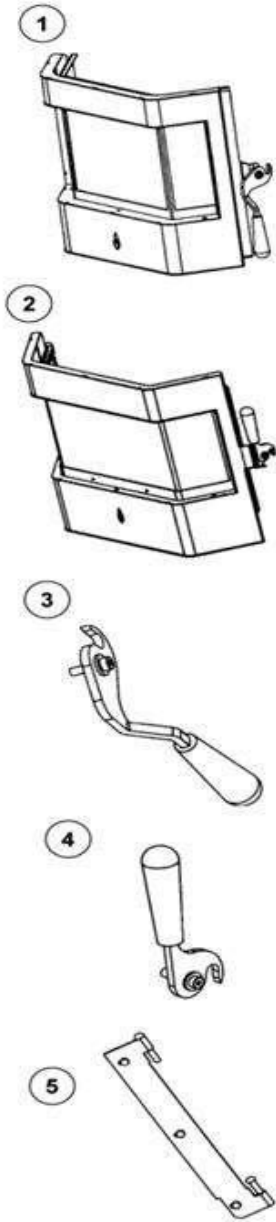

Profile Series

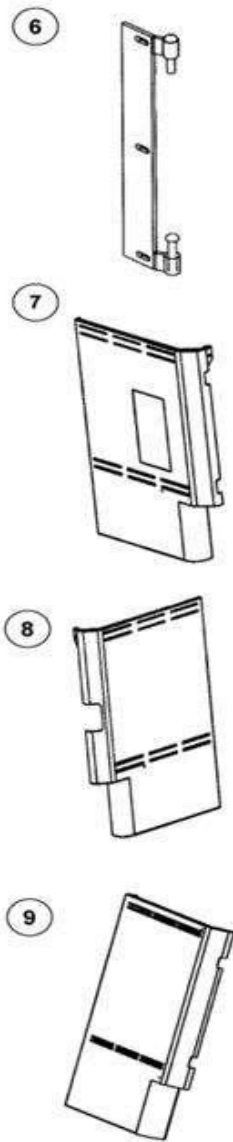

Whitfield

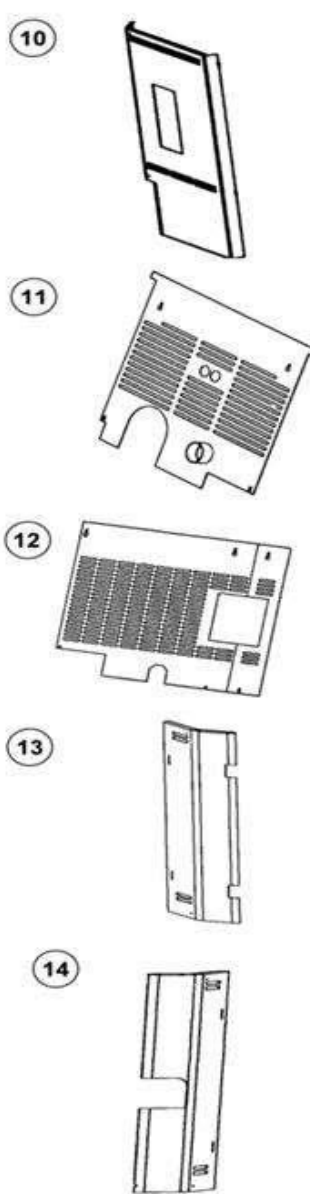

P37

Profile Series Whitfield Pellet

Pellet

Profile Series

Whitfield

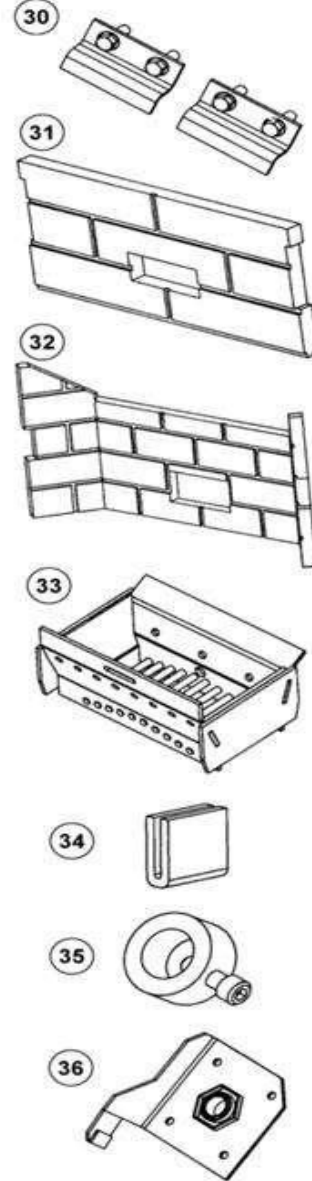
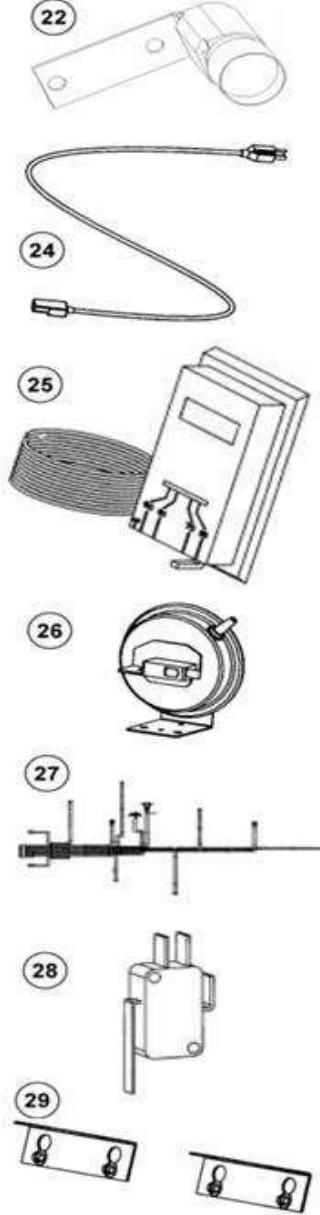
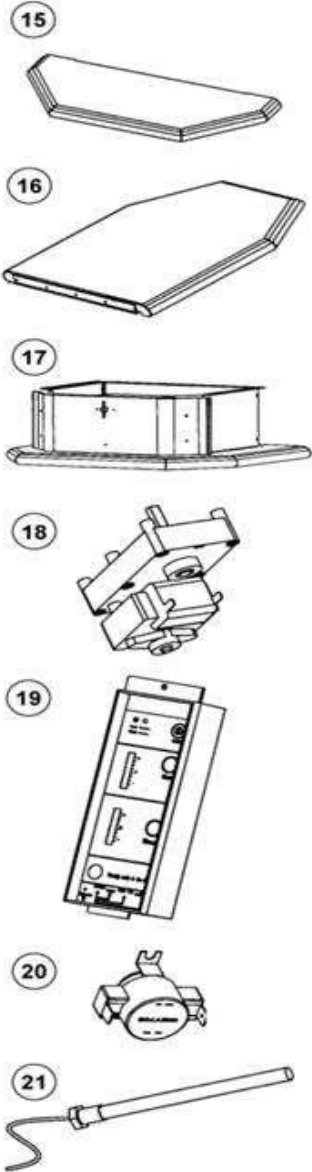

Profile Series Whitfield Pellet

Pellet

Profile Series

Whitfield

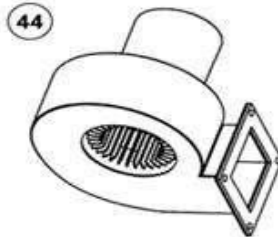
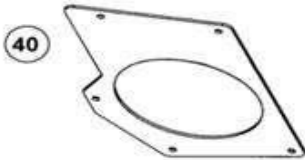
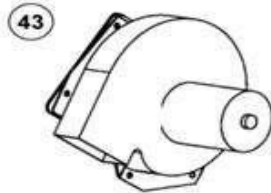
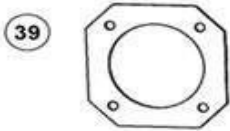
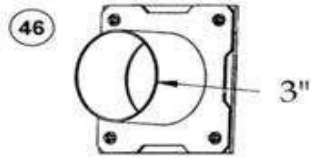
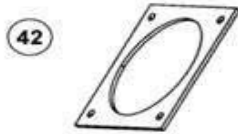
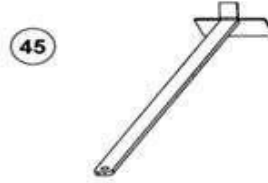
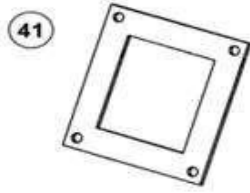
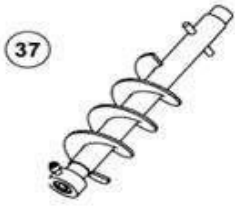

QUEST FS Whitfield Pellet

QUEST FS

Pellet, Freestanding, WP4

MODEL YEARS: 1994 - 2000

(click the link for parts and ordering)

PART #

DESCRIPTION

Door Parts

13640075	Clip Kit, Glass Bottom
13640087	Bracket, Window Wash
13640075	Clip Kit, Glass Bottom
13640086	Clip Kit, Glass Side
13640085	Clip Kit, Glass Top
13650231	Door Assembly, Black (*SN 1001 - 12139) Painted
13750800	Door Assembly, Black (*SN 12140 - 29935) F/S Only
13650232	Door Assembly, Brown (*SN 1001 - 12139) Painted
13750801	Door Assembly, Brown (*SN 12140 - 29935) F/S Only
13750803	Door Assembly, Green (*SN 12140 - 29935) F/S Only
13650234	Door Assembly, Slate (*SN 1001 - 12139) Painted
13750802	Door Assembly, Slate (*SN 12140 - 29935) F/S Only
61057100	Gasket Kit, Door (1/2" diameter, firm, 7')
H0257	Glass, Center (Includes gasket)
H0258	Glass, Side (Includes gasket)
13644201	Handle Assembly, Door - Black
13644202	Handle Assembly, Door - Brown
13644204	Handle Assembly, Door - Slate
13644205	Handle Assembly, Green Door
12054200	Handle, Wood Door (Pkg. of 2)
12050506	Hinge Pin (2 per Pkg.) (52L16)
72045000	Shoulder Bolt (Door latch hardware)
72045001	Shoulder Bolt w/ Roller

Body Components

13650046	Baffle, Heat Exchange
13740005	Bracket, Hopper Lid Support
13751154	Lid, Hopper - Black, Painted
13752154	Lid, Hopper - Brown, Painted
13754154	Lid, Hopper - Slate, Painted
13751054	Lid, Hopper, Black, Powder Coated
13752054	Lid, Hopper, Brown, Powder Coated
13755054	Lid, Hopper, Green, Powder Coated
13754054	Lid, Hopper, Slate, Powder Coated
13641232	Louvers (Gold - option)
13751231	Panel, Left Side - Black, Painted
13752231	Panel, Left Side - Brown, Painted
13754231	Panel, Left Side - Slate, Painted
13751048	Panel, Left Side, Black, Powder Coated
13752048	Panel, Left Side, Brown, Powder Coated

QUEST FS Whitfield Pellet

(click the link for parts and ordering)

13755048	Panel, Left Side, Green, Powder Coated
13754048	Panel, Left Side, Slate, Powder Coated
13751156	Panel, Rear, Black, Painted
13752156	Panel, Rear, Brown, Painted
13754154	Panel, Rear, Slate, Painted
13751147	Panel, Right Side - Black, Painted
13752047	Panel, Right Side - Brown, Painted
13754147	Panel, Right Side - Slate, Painted
13755047	Panel, Right Side, Green, Powder Coated
13754047	Panel, Right Side, Slate, Powder Coated
13755100	Pedestal - Black, Painted
13755200	Pedestal - Brown, Painted
13755400	Pedestal - Slate, Painted
13755111	Pedestal, Black, Powder Coated
13755211	Pedestal, Brown, Powder Coated
13755511	Pedestal, Green, Powder Coated
13755411	Pedestal, Slate, Powder Coated

Electrical Parts

13746010	Blower, Exhaust w/ Housing (FS)
13646109	Blower, Room Air
13645900	Control Board
13057801	Disc, High Limit (250 deg., 36T) 4 per pkg.
12057601	Disc, Low Limit (Ceramic, F140-30F) 3 per pkg.
61057210	Gasket, Exhaust Blower Mounting (5 per pkg.)
61057203	Gasket, Room Air Blower Mounting (5 per pkg.)
12046300	Motor, Auger
12058820	Power Cord (52L17)
13640014	Pressure Switch (Hose, PN 13656003, not included)
13656003	Hose, Pressure Switch, 19" (may need to be cut to size) - 3 per pkg.
13648000	Wire Harness

Auger System Components

13652100	Auger Shaft Kit
12041300	Collar, Auger (Includes Set Screw)
61050003	Gasket, Auger Retention Plate (5 per pkg.)
13650072	Plate, Auger End (w/ Nylatron Bushing)

Miscellaneous Parts

13740003	Cable, Damper (Freestanding)
72043008	Clamp, Cable
13640002	Knob, Auger Control (2 per pkg.)
12051409	Knob, Control Door
12055500	Tool, Grate Scraper

Firebox Parts

13650018	Ash Pan
13650046	Baffle, Heat Exchanger
13640028	Clip, Brick (2 per pkg.)
13646500	Firebrick
13650015	Rod, Heat Exchange Scraper
12051263	UltraGrate, Replacement

* SN - Stove serial number range, parts are compatible with:

">" = greater than # indicated, "<" = less than # indicated, "-" = numbers within range.

QUEST INS Whitfield Pellet

QUEST INS

Pellet, Insert, WP4

MODEL YEARS: 1994 - 2000

(click the link for parts and ordering)

PART #

DESCRIPTION

Door Parts

13640087	Bracket, Window Wash
13640075	Clip Kit, Glass Bottom
13640086	Clip Kit, Glass Side
13640085	Clip Kit, Glass Top
13650231	Door Assembly, Black (*SN 1001 - 12139)
13850804	Door Assembly, Black (*SN 12140-29935)
13650232	Door Assembly, Brown (*SN 1001 - 12139)
13850805	Door Assembly, Brown (*SN 12140-29935)
13850807	Door Assembly, Green (*SN 12140-29935)
13650234	Door Assembly, Slate (*SN 1001 - 12139)
13850806	Door Assembly, Slate (*SN 12140-29935)
61057100	Gasket Kit, Door (6' of 1/2" rope)
H0257	Glass, Center (12050020)
H0258	Glass, Side (12050021)
13644201	Handle Assembly, Door - Black
13644202	Handle Assembly, Door - Brown
13644205	Handle Assembly, Door - Green
13644204	Handle Assembly, Door - Slate
12054200	Handle, Wood Door
12050506	Hinge Pin (2 per pkg.)
13624501	Latch, Door
72045000	Shoulder Bolt (Door latch hardware)
72045001	Shoulder Bolt w/ Roller

Body Components

13740005	Bracket, Hopper Lid Support
13850001	Lid, Hopper - Black
13851078	Lid, Hopper - Black, Powder Coated
13850002	Lid, Hopper - Brown
13852078	Lid, Hopper - Brown, Powder Coated
13855078	Lid, Hopper - Green, Powder Coated
13850003	Lid, Hopper - Slate
13854078	Lid, Hopper - Slate, Powder Coated
13641232	Louvers (Gold - option)
13858100	Surround, Large, Black
13858110	Surround, Large, Black, Powder Coated
13858200	Surround, Large, Brown
13858210	Surround, Large, Brown, Powder Coated
13858510	Surround, Large, Green, Powder Coated
13858400	Surround, Large, Slate

QUEST INS Whitfield Pellet

(click the link for parts and ordering)

[13858410](#) Surround, Large, Slate, Powder Coated
[13856100](#) Surround, Small, Black
[13856110](#) Surround, Small, Black, Powder Coated
[13856200](#) Surround, Small, Brown
[13856210](#) Surround, Small, Brown, Powder Coated
[13856510](#) Surround, Small, Green, Powder Coated
[13856400](#) Surround, Small, Slate

Electrical Parts

[12046300](#) Auger Motor
[13846010](#) Blower, Exhaust (w/ Housing) - Insert
[13646109](#) Blower, Room Air
[13645900](#) Control Board
[13057801](#) Disc, High Limit (250 Deg.), 4 per pkg.
[12057601](#) Disc, Low Limit (Ceramic, F140-30F), 3 per pkg.
[12058820](#) Power Cord
[13640014](#) Pressure Switch (see PN 13656003 for hose, not included)
[13648000](#) Wire Harness

Auger System Components

[13652100](#) Auger Shaft Kit
[12041300](#) Collar, Auger (Includes Set Screw)
[61050003](#) Gasket, Auger Retention Plate - 5 per pkg.
[13650072](#) Plate, Auger End (w/ Nylatron Bushing)

Miscellaneous Parts

[13840003](#) Cable, Damper - Insert
[72043008](#) Clamp, Cable
[61057210](#) Gasket, Exhaust Blower Mounting, 5 per pkg.
[61057203](#) Gasket, Room Air Blower Mounting - 5 per pkg.
[13656003](#) Hose, Pressure Switch, 19" (may need to be cut to size) - 3 per pkg.
[12051409](#) Knob, Control Door
[13640002](#) Knob, Control, Auger - 2 per pkg.
[12055500](#) Tool, Grate Scraper

Firebox Parts

[13650018](#) Ash Pan
[13650046](#) Baffle, Heat Exchanger
[13640028](#) Clip, Brick - 2 per pkg
[13646500](#) Firebrick
[13650015](#) Rod, Heat Exchange Scraper
[12051263](#) UltraGrate

* SN - Stove serial number range, parts are compatible with:

">" = greater than # indicated, "<" = less than # indicated, "-" = numbers within range.

QUEST PLUS FS Whitfield Pellet

QUEST PLUS FS

Pellet, Freestanding, WP4

MODEL YEARS: 1998 - 2000

(click the link for parts and ordering)

PART #

DESCRIPTION

Door Parts

13640075	Clip Kit, Glass Bottom
13640086	Clip Kit, Glass Side
13640085	Clip Kit, Glass Top
17251083	Door Assembly, Black, Painted
17253083	Door Assembly, Brown, Painted
17255083	Door Assembly, Green, Painted
17254083	Door Assembly, Slate, Painted
17250093	Door Hinge Bracket
61057100	Gasket Kit, Door (1/2" diameter, firm, 7')
61057202	Gasket, Glass, 10' (5/8" x 1/16" flat)
H0257	Glass, Center (Includes gasket)
H0258	Glass, Side (Includes gasket)
17250095	Handle Assembly, Door - Black
72045000	Hardware, Door Latch
12050506	Hinge Pins, Gold (2 per pkg.) 52L16

Body Components

17351154	Lid, Hopper, Black
17353154	Lid, Hopper, Brown
17355154	Lid, Hopper, Green, Powder Coated
17354154	Lid, Hopper, Slate
17351148	Panel, Left Side, Black, Powder Coated
17353148	Panel, Left Side, Brown, Powder Coated
17355148	Panel, Left Side, Green, Powder Coated
17354148	Panel, Left Side, Slate, Powder Coated
17350156	Panel, Rear, Black
17351147	Panel, Right Side, Black, Powder Coated
17353147	Panel, Right Side, Brown, Powder Coated
17355147	Panel, Right Side, Green, Powder Coated
17354147	Panel, Right Side, Slate, Powder Coated
17355100PT	Pedestal w/ Ash Pan, Black, Painted
17355100	Pedestal w/ Ash Pan, Black, Powder Coated
12041300	Collar, Auger (w/setscrew)

Electrical Parts

12050011	Blower, Exhaust
12146109	Blower, Room Air
17255912	Control Board
12147705	Disc, High Limit (L250-30F, Bakelite, 60T21) 3 per pkg.
12057601	Disc, Low Limit (Ceramic, F140-30F) 3 per pkg.
12140213	Igniter, Cartridge Replacement
12040003	Igniter Kit, 6 pack
12058820	Power Cord (52L17)
12145903	Pressure Switch
12058811	Wiring Harness

QUEST PLUS FS Whitfield Pellet

(click the link for parts and ordering)

Miscellaneous Parts

- [13640028](#) Clip Set, Firebrick (2 ea.)
- [17250029](#) Firebrick Kit
- [61050016](#) Gasket, Quick Disconnect (5 per pkg.)
- [61050003](#) Gasket, Auger Retention Plate (5 per pkg.)
- [61050005](#) Gasket, Exhaust Blower, 5 per pkg.
- [61057203](#) Gasket, Room Air Blower (5 per pkg.)
- [13656003](#) Hose, Pressure Switch, 19" (may need to be cut to size) - 3 per pkg.
- [12050093](#) Quick Disconnect 3" Vent Side
- [11751305](#) Rod, Damper
- [17150009](#) Rod, Scraper

Firebox Parts

- [13650046](#) Baffle, Heat Exchange
- [17250241](#) Log Set
- [16050246](#) Ultragrate

QUEST PLUS INS Whitfield Pellet

QUEST PLUS INS

Pellet, Insert, WP4

MODEL YEARS: 1998 - 1999

(click the link for parts and ordering)

PART #

DESCRIPTION

Door Parts

18140046	Bracket, Door Latch
13640075	Clip Kit, Glass Bottom
13640086	Clip Kit, Glass Side
13640085	Clip Kit, Glass Top
17251083	Door Assembly, Black, Painted
17253083	Door Assembly, Brown, Painted
17255083	Door Assembly, Green, Painted
17254083	Door Assembly, Slate, Painted
13644201	Door Handle Assembly, Black
17250093	Door Hinge Bracket
61057100	Gasket Kit, Door (1/2" diameter, firm, 7')
61057202	Gasket Kit, Glass (Flat 5/8" x 1/16", 10')
H0257	Glass, Center (Includes gasket)
H0258	Glass, Side (Includes gasket)
72045000	Hardware, Door Latch (Shoulder Bolt)
12050506	Hinge Pins, Gold (2 per pkg.) 52L16

Body Components

17450004	Ash Pan
13851078	Lid, Hopper, Black
13852078	Lid, Hopper, Brown
13855078	Lid, Hopper, Green
13854078	Lid, Hopper, Slate
17451187	Panel, Left Side, Black, Powder Coated
17453187	Panel, Left Side, Brown, Powder Coated
17455187	Panel, Left Side, Green, Powder Coated
17454187	Panel, Left Side, Slate, Powder Coated
17451192	Panel, Lower, Black, Powder Coated
17453192	Panel, Lower, Brown, Powder Coated
17455192	Panel, Lower, Green, Powder Coated
17454192	Panel, Lower, Slate, Powder Coated
17451188	Panel, Right Side, Black, Powder Coated
17453188	Panel, Right Side, Brown, Powder Coated
17455188	Panel, Right Side, Green, Powder Coated
17454188	Panel, Right Side, Slate, Powder Coated
17458100	Surround, Large, Black, Powder Coated
17458300	Surround, Large, Brown, Powder Coated
17458500	Surround, Large, Green, Powder Coated
17458400	Surround, Large, Slate, Powder Coated
17456100	Surround, Small, Black, Powder Coated

QUEST PLUS INS Whitfield Pellet

(click the link for parts and ordering)

[17456300](#) Surround, Small, Brown, Powder Coated

[17456500](#) Surround, Small, Green, Powder Coated

[17456400](#) Surround, Small, Slate, Powder Coated

Electrical Parts

[12050011](#) Blower, Exhaust

[12146109](#) Blower, Room Air

[17255912](#) Control Board

[12140213](#) Igniter, Cartridge Replacement

[12040003](#) Igniter Kit, 6 pack

[12058820](#) Power Cord, Molded End, 8'

[16050001](#) Pressure Switch (Hose, 13656003, not included)

Auger System Components

[17250241](#) Plate, Auger End

[12046300](#) Auger Motor

[11756300](#) Auger Shaft Kit

[12041300](#) Collar, Auger (w/ Set Screw)

[61050003](#) Gasket, Auger Retention Plate (5 per pkg.)

Miscellaneous Parts

[17450132](#) Exhaust Tee

[61050005](#) Gasket, Exhaust Blower

[61057210](#) Gasket, Mounting, Room Air Blower (5 per pkg.) 1/8" Lytherm

[13656003](#) Hose, Pressure Switch (19") 3 per pkg.

[13656003](#) Hose, Pressure Switch, 19" (may need to be cut to size) - 3 per pkg.

Firebox Parts

[13650046](#) Baffle, Heat Exchange

[13640028](#) Clip Set, Firebrick - 2 per pkg

[17250029](#) Firebrick Kit

[16050246](#) UltraGrate

Renaissance Whitfield Pellet

Renaissance

Pellet, Freestanding, WW1

MODEL YEAR: 1990 - 1994 (Serial #1001 & Up)

(click the link for parts and ordering)

PART

DESCRIPTION

Doors Parts

14004300	Deflector, Window Wash
61057101	Gasket Kit, Door , WP3/WW1 (3/8", medium rope)
14055015	Glass Kit, Replacement (9" x 14-3/4") - WW1
14024200	Handle, Door, Oak, WW1

Electrical Parts

13046109	Blower, Hall Effect Room Air and Exhaust (use with SSAC control board; *SN 3608 & up). Functions as Neg. Press Comb. Air (push) into firebox and Room Air Blower
13057801	Disc, High Limit (250 Deg.) - 4 per pkg. Obsolete-Knob, Control Board Heat Output - 2 per pkg.
13050002	Microswitch, WW1/WP3
12046300	Motor, Auger (Drives pellet feed auger)
13025903	Pressure Switch Kit (FS6569-1018; B.P. @ +.10 in. W.C.; blue label)
13656003	Hose, Pressure Switch, 19" (may need to be cut to size) - 3 per pkg.
13045909	Relay, Latch-out (*SN 1001 - 3607)
13020003	Spring, Microswitch Actuation Spring, WW1/WP3 (conical)
16050205	Thermostat, Wall, Honeywell (Wire, 16020204, not included)
16020204	Wire, Thermostat, 20' coil - 18 gage
12055907	Fuse, 2.5 Amp (Ser. #1001-3607)
12055908	Fuse, 6 Amp (Ser. #3608-Up)

Auger System Components

13052100	Auger Shaft Kit
61050003	Gasket, Auger End Plate (Neoprene) - 5 per pkg.
13052000	Plate, Auger End - WW1/WP3

Miscellaneous Parts

14055000	Duct Kit, Exhaust
61020002	Gasket, Exhaust Connector
61020001	Gasket, Exhaust Duct Plug (round, lytherm)
14000906	Scraper Rod, 1/4", Tube (bent) **
14020906	Scraper Rod, 3/16", Tube (bent) **
13540001	"U"-tube Removal Kit, Secondary Air
12045901	Control Cable