

**LENNOX HEARTH PRODUCTS****Service Replacement Parts List****Models Advantage Optima 2 FS, Optima 3 FS & Optima 3 INS**

Freestanding and Insert Pellet Stoves

MODEL YEARS: 2002 - present

ITEM NO	DESCRIPTION	Stove Model
<b>Door Parts &amp; Body Components</b>		
14650414	Ash Pan Cover	Optima 2 FS
14750460	Ash Pan Cover	Optima 3 FS
14750605	Ash Pan Cover	Optima 3 INS
14650460 (*2)	Door Assembly, Cast Iron Firebox	Optima 2 FS
14750458 (*2)	Door Assembly, Cast Iron Firebox	Optima 3 FS & INS
26M81	Gasket Kit, Door, ¾" Rope, (10 Ft.)	Optima 2 FS
61051000	Gasket Kit, Door, 1" Rope, (7 Ft.)	Optima 3 FS & INS
61057202	Gasket Kit, Glass (5/8" x 1/16" x 10 Ft.)	All
H0257	Glass, Front, Includes gasket	Optima 2 FS
H0258	Glass, Side (order 2 if set is needed), Includes gasket	Optima 2 FS
H0254	Glass, Front, Includes gasket	Optima 3 FS & INS
H0255	Glass, Side (order 2 if set is needed) Includes gasket	Optima 3 FS & INS
14650446 (*5)	Hinge Bracket	Optima 2 FS
14750700 (*6)	Hinge Bracket	Optima 3 FS & INS
13740005	Hopper Lid Hinge Brackets	Optima 2 FS & 3 FS
11950068	Hopper Lid Hinge Brackets	Optima 3 INS
14750406 (*3)	Knob Kit, Door (includes latch, 3 washers, nut and door latch receiver)	All
14750405 (*4)	Opener, Door Handle	All
14650450 (*7)	Panel, Left Side	Optima 2 FS
14650451 (*8)	Panel, Right Side	Optima 2 FS
14750449 (*9)	Panel, Left Side	Optima 3 FS
14750448 (*10)	Panel, Right Side	Optima 3 FS
14650456 (*11)	Panel, Rear	Optima 2 FS
14750465 (*12)	Panel, Rear	Optima 3 FS
14750612 (*13)	Panel, Left Side	Optima 3 INS
14750613 (*14)	Panel, Right Side	Optima 3 INS
14750617 (*15)	Panel, Top (hopper lid)	Optima 3 INS
14650455 (*16)	Panel, Top (hopper lid)	Optima 2 FS
14750455 (*16)	Panel, Top (hopper lid)	Optima 3 FS
12051409	Knob, Control Panel Door (6 per package w/studs)	Optima 3 INS
<b>Electrical Parts</b>		
12046300 (*17)	Auger Motor	All
12146109 (*28)	* Blower, Convection, Hard Washer ( Includes gasket and four nuts)	All
12050011 (*27)	Blower, Exhaust	All
16053941 (*18)	Control Board	Optima 2 FS
16052112 (*18)	Control Board	Optima 3 FS & INS
12147705 (*19)	Disc, High Limit, 250 DG (L250-30F,60T21) Set of 3	All

18150150	Fuse, Control Board, 5 Amp, 250 volt, Fast blow, 12 pk.	All
12055908	Fuse, Igniter, 6 Amp, 125 volt, Fast blow, 12 pk.	All
12140213 (*20)	Igniter Probe, 400 W, 4.8 A	All
14750404 (*22)	Photoeye Kit, Replacement	All
12058820 (*23)	Power Cord, 8 feet	All
16050001 (*25)	Pressure Switch	All
16050205 (*24)	Thermostat, Wall	All
12050815 (*26)	Wiring Harness	All
<b>Firebox Parts</b>		
13640028 (*29)	Clips, Brick	Optima 2 FS
11750011 (*30)	Clips, Brick	Optima 3 FS & INS
14750469	Firebox Baffle	Optima 3 FS & INS
13650046	Firebox Baffle	Optima 2 FS
14650011 (*31)	Firebrick Set, 1 pc.	Optima 2 FS
14750015 (*32)	Firebrick Set, 3 pc.	Optima 3 FS & INS
14650428 (*33)	Housing, Igniter Tube	Optima 2 FS
14750421 (*34)	Housing, Igniter Tube	Optima 3 FS & INS
12158905 (*35)	UltraGrate™	All
<b>Auger System Components</b>		
11756300 (*40)	Auger Shaft	All
12051001 (*36)	Bumper, Auger (Set of 5)	All
12041300 (*37)	Collar & Screw Set, Auger (Set of 3)	All
20950088 (*38)	Flange, Auger (end plate)	All
<b>Miscellaneous</b>		
14650408	Ash Pan	Optima 2 FS
14750409	Ash Pan	Optima 3 FS
14750603	Ash Pan	Optima 3 INS
12151307	Collar, Damper Rod St, 1/4" (w/set screw)	Optima 2 FS & 3 FS
12151309	Damper Rod, Complete	Optima 2 FS & 3 FS
14750312	Damper Rod, Complete	Optima 3 INS
11750004	Damper Rod, Knob (6 per pack)	All
17150009 (*39)	Rod Kit, Scraper (includes rod, collar and knob)	All
15050058 (*41)	Filter, Photoeye	All
14650060	Gasket, Photoeye	Optima 2 FS
14750060	Gasket, Photoeye	Optima 3 FS & INS
61050003 (*42)	Gasket, Auger Flange, 5pc.	All
61050005 (*43)	Gasket, Exhaust blower, 5pc.	All
61057203 (*44)	Gasket, Room air blower, 5pc.	All
61050016 (*45)	Gasket, Quick Disconnect 5pc.	All
12055500 (*46)	Tool, Grate Scraper	All
12050093 (*47)	Quick Disconnect 3" Vent Side	All
16020011	Video, Advantage Optima	All

Pellet

Advantage Optima 2 FS,  
Optima 3 FS, Optima 3 INS

Whitfield

2

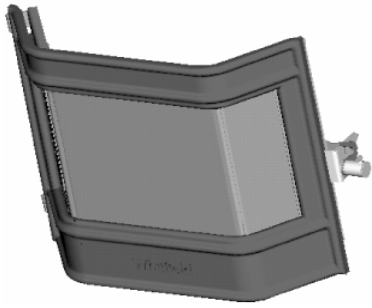

3

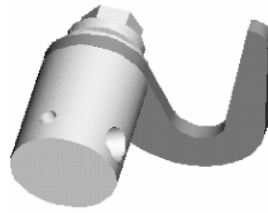

4

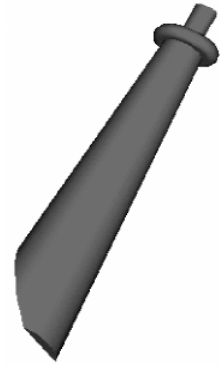

[www.WoodHeatStoves.com](http://www.WoodHeatStoves.com)

Pellet

Advantage Optima 2 FS,  
Optima 3 FS, Optima 3 INS

Whitfield

5

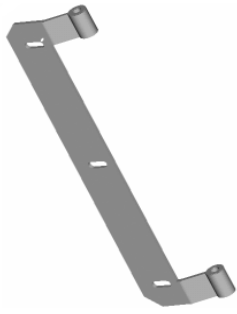

9

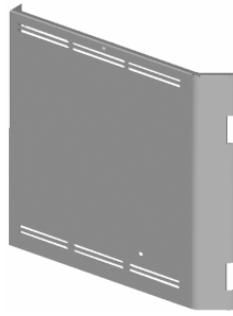

12

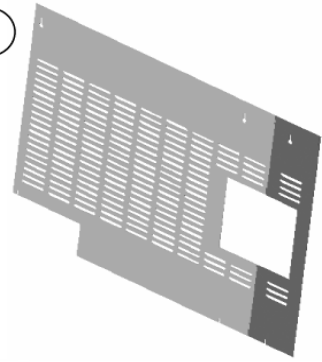

6



10

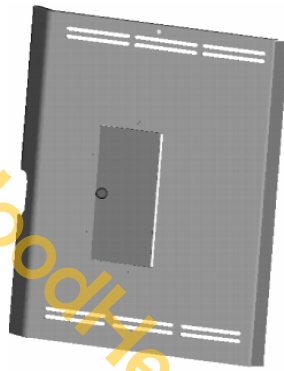

13

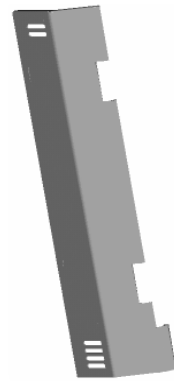

7

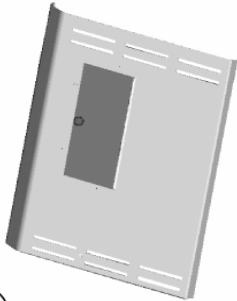

14



8



11



[www.WoodHeatStoves.com](http://www.WoodHeatStoves.com)

15

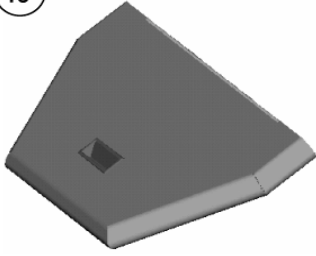

16

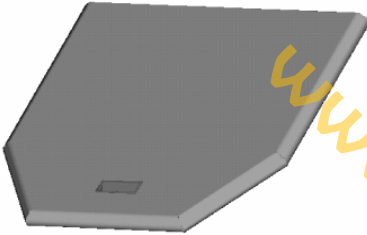

17

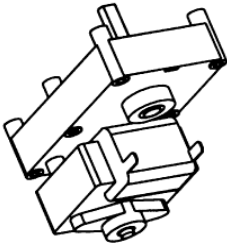

18

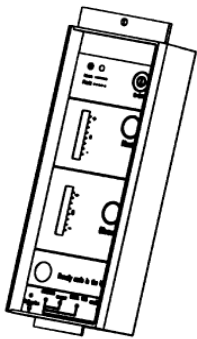

19



20

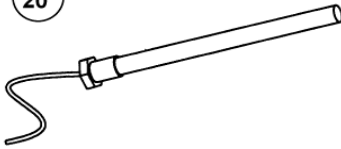

22

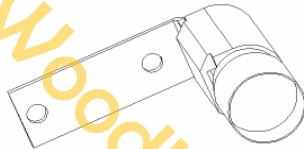

23

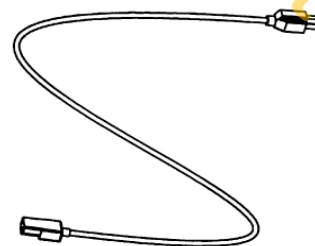

24

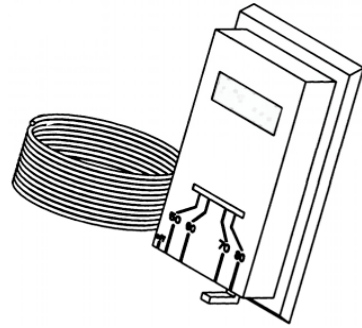

25



26

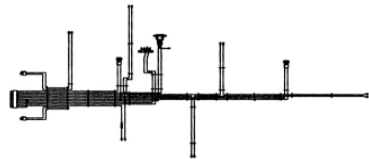

27

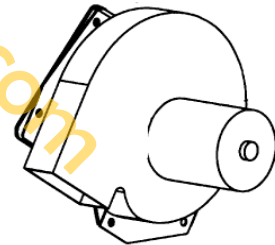

www.WoodHeatStoves.com

28

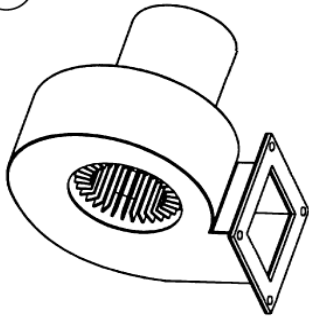

32

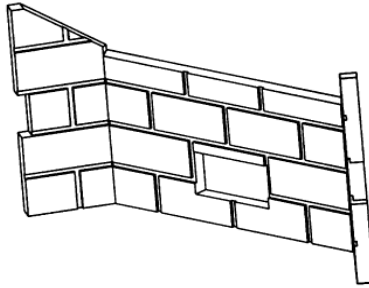

37



29

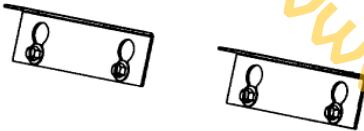

33

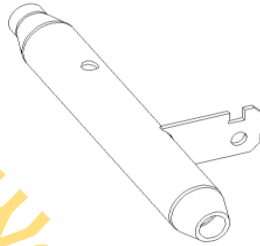

38

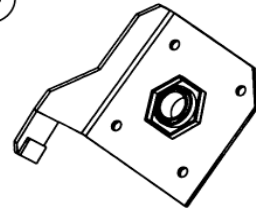

30

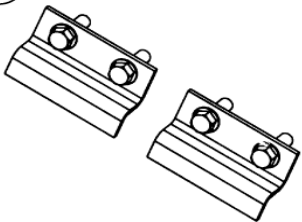

34

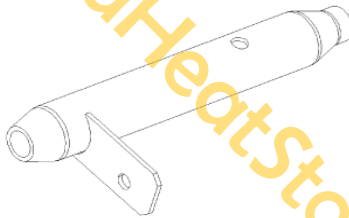

39

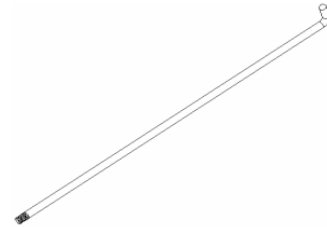

31

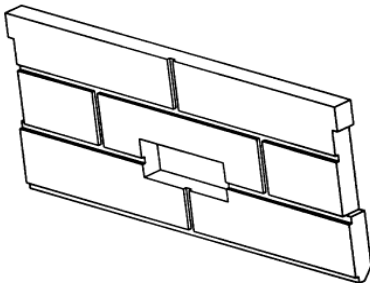

35

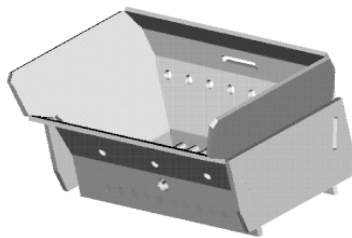

40

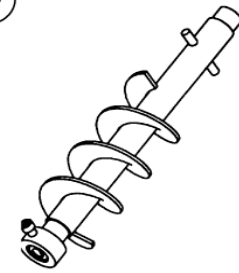

36

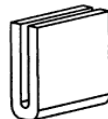

41

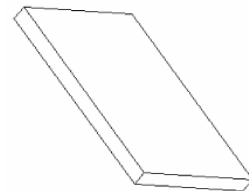

www.WoodHeatStoves.com