

LENNOX HEARTH PRODUCTS

Service Replacement Parts List

BayFire™ XL

Gas, B-Vent, Insert

MODEL YEARS: 1997 - 2001

ITEM NO	DESCRIPTION
Door Parts	
51014	Clip, Glass Side (Order 2 if set is needed)
51013	Clip, Glass Side Top/Bottom (Order 2 if set is needed)
51012	Clip, Glass Top Side (Order 2 if set is needed)
51015	Clip, Glass Top/Bottom (Order 2 if set is needed)
51010 (*4)	Door Assembly, Gold (w/ 3 pc. Glass)
26M81	Gasket Kit, 3/4" Rope Door (adhesive not included. use RTV high-temp. silacone as an adhesive)
27M81	Gasket Kit, Glass and Ash Drawer (10' of 10580)
51017(*6)	Glass, Center 15 5/16 x 15 3/4" (Gasket not included)
51016 (*5)	Glass, Side 15 5/16 x 7 5/8" (Gasket not included, Order 2 if set is needed)
Gas & Electrical Parts (for blower parts, see <i>Room Air Blower Parts</i>)	
45091	Battery Box, Igniter (AA battery not included)
51053 (*8)	Burner Tube, Set (Main Burner and Ember Burner)
18253	Disc, High Limit (Spill Switch, Auto Reset, L250-40F)
11450091	Gas Line, Flex, 3/8" Dia. x 24" - 4 per pkg.
51056	Orifice, Burner, Natural Gas, Front #53
34062	Orifice, Burner, Natural Gas, Rear #30
51058	Orifice, Burner, Propane, Front #61
51059	Orifice, Burner, Propane, Rear #50
75L1201	Orifice, Pilot (#51) - Natural Gas - Fits pilot P/N 42M2101 (new style) - see notes. ***
75L1301	Orifice, Pilot (#35) - Propane - Fits pilot P/N 42M2201 (new style) - see notes. ***
45143H	Orifice, Pilot (#51) - Natural Gas - Fits pilot P/N 45059H (old style) - see notes. **
45144	Orifice, Pilot (#35) - Propane - Fits pilot P/N 45063H (old style) - see notes. **
42M2101	Pilot Assembly, Natural Gas (new style w/detachable pilot hood. Fits all revisions of this model. Replaces P/N 45059H. Pilot includes pilot tube) ***
42M2201	Pilot Assembly, Propane (new style w/detachable pilot hood. Fits all revisions of this model. Replaces P/N 45063H. Pilot includes pilot tube) ***
26M76	Pilot Tube Kit, 0.199.620, 24", includes fittings
45135	RB Regulator, 1.7 to 3.5" WC - Natural Gas (Controls flame height)
45136	RB Regulator, 6.3 to 10" WC - Propane (Controls flame height)
45061	Switch, Igniter Battery
410-270 (*1)	Switch, On/Off (Burner)
49119	Thermocouple, 24" / no pilot bracket fitting (provided on pilot bracket) (units mfg'r'd < 3/99)
32041	Thermocouple, 24" w/ pilot bracket fitting (units mfg'r'd > 3/99)
18050	Thermopile, 24"
89L36	Thermostat, Wall, MV (10NG4, 18120)
52L05 (*14)	Valve, Control, SIT - Natural Gas (25060)
10850057 (*14)	Valve, Control, SIT - Propane (25070)
51062	Wire Harness, Burner
45062	Wire, 12" Ground (For Igniter)
45066	Wire, Igniter (24")

Room Air Blower Parts	
51040 (*12)	Blower Assembly, Room Air
15049 (*3)	Disc, Low Limit (blower, F140°-20F)
527	Knob, Rheostat
51047 (*13)	Power Cord (Includes Wire Harness)
528 (*2)	Rheostat w/ Connectors (Knob Not Included)
Surround Parts	
2046	Brackets, Surround Trim (Corner Key's/L bracket) - Order 2 if set is needed
51032-1	Door, Gas Shut-Off (On Right Surround Panel) i
43033	Magnetic Strip (for gas shut-off door. order 2; self adhesive)
50009K	Surround Kit, 32 x 42", Standard
32130	Trim Set, Gold Tone (for surround, 32 x 42")
Miscellaneous Parts	
49140	Conversion Kit, Natural Gas to Propane
49130	Conversion Kit, Propane to Natural Gas
51027	Door, Left Side Hinged ①
51028	Door, Right Side Hinged ①
51130	High Altitude Kit
70K99	Paint, Black Metallic (12 oz. Spray #6309) ♦ ☒
49020	Paint, Powder Coat Touch Up (Black, 3 oz. Bottle) ♦ ☒
18238	Plug, Draft Port
00022H	Plug, Surround
H0249	Remote Control, Standard, on/off, radio frequency (26N04, 40025000, 25050)
H0251	Remote Control, Deluxe w/thermostat, radio frequency (98K99, 3001)
51026 (*15)	Top (Body Trim) 34 x 10" (Requires (2) #8 x 1/2" Tek Screws) ①
51024	Trim Panel, Top (Gold Inset)
Firebox & Log Parts	
88L53	Embers, Glowing, 1 oz. Bag (order a minimum of 10 for maintenance needs)
51105 (*10)	Log Set, 5 pc. Fiber (3-99 to present)
51101 (*9)	Log Set, 5 pc. Fiber (prior to 3-99)
51102	Panel Set, 2 pc. Brick (Blond)

① Units shipped from the factory after 3-31-99 & prior to 4-15-98 have a painted finish. Units shipped from 4-15-98 to 3-31-99 have a powdercoat finish. When ordering replacement parts with powdercoat finish add the letter "B" to the part number (ie. 51032B is a surround panel with a powdercoat finish).

♦ Note: Units with a powdercoat finish can be identified by the work order number printed on the body; work order number 1288 and below are powdercoat, work order number 1289 and above are painted.

☒ CAUTION: Units with powdercoat finish, use only the powdercoat touch-up paint designed for this finish. DO NOT use stove paint as a touch-up because it will react with the powdercoat finish.

☒ Includes thermocouple, thermopile, pilot orifice, pilot tube and igniter electrode. The igniter wire, P/N 45066, is not included.

* The numbers in parenthesis correspond to the component diagrams on the following page(s).

** Fits pilot assemblies w/o a detachable pilot hood (the pilot tube fitting requires removal to install. Body of pilot hood does not have a visible clip.)

*** Fits pilot assemblies w/detachable pilot hood (there is a visible clip on the body of the pilot hood which must not be removed when installing pilot orifice).

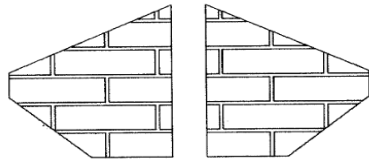

(7) 2 PC. BRICK PANEL SET

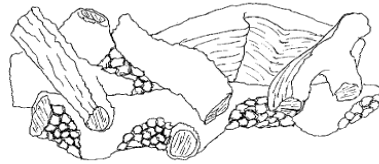

(9) LOG SET (FITS UNITS MANUFACTURED BEFORE 3/99)

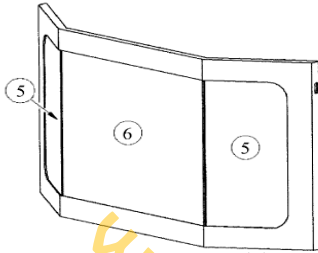

(4) DOOR ASSEMBLY



(10) LOG SET (FITS UNITS MANUFACTURED AFTER 3/99)

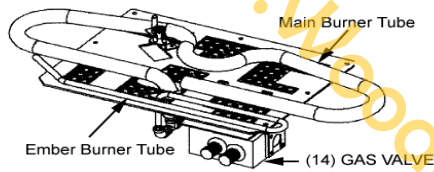

(8) BURNER TUBE SET

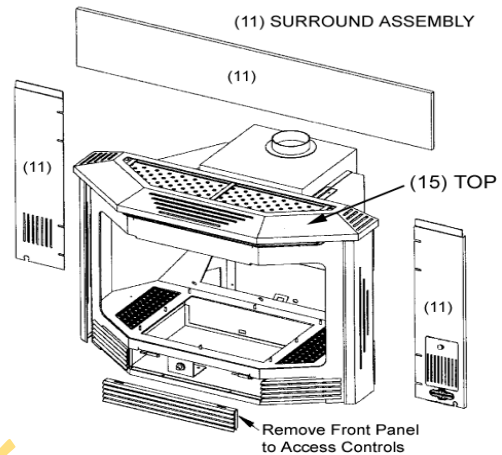

(11) SURROUND ASSEMBLY

(15) TOP

Remove Front Panel to Access Controls

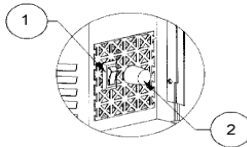

(13) BLOWER WIRE HARNESS

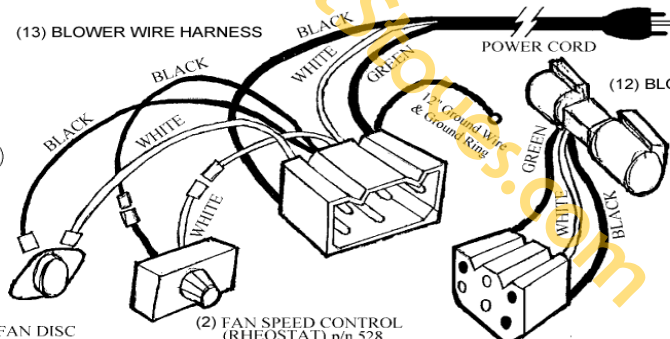

(12) BLOWER ASSEMBLY

(3) FAN DISC F140-20F

(2) FAN SPEED CONTROL (RHEOSTAT) p/n 528

BURNER ON/OFF SWITCH, P/N 410-270

IGNITER SWITCH, P/N 45061

RB REGULATOR NG - P/N 45135 LP- P/N 45136

PILOT / ON / OFF KNOB, P/N 39020

BATTERY BOX, P/N 45091