

LENNOX HEARTH PRODUCTS

Service Replacement Parts List

BavFire™ L Gas, B-Vent, Insert MODEL YEARS: 1998 - 2001

ITEM NO	DESCRIPTION
Door Parts	
49054	Clip, Glass Top/Bottom (Order 2 if set is needed)
49055	Clip, Side (Order 2 if set is needed)
49056	Clip, Upper Left, Lower Right (Order 2 if set is needed)
49057	Clip, Upper Right, Lower Left (Order 2 if set is needed)
49050 (*4)	Door Assembly, Gold
26M81	Gasket Kit, 3/4" Door Rope (adhesive not included. use RTV high-temp. silacone as an adhesive)
27M81	Gasket Kit, Glass & Ash Drawer (10' of 10580)
49052	Glass, Center 14 1/8 x 14 13/16" (gasket not included)
49053	Glass, Side 14 1/8 x 6 5/16" (Order 2 if set is needed) ✓
Gas & Electrical Parts - For blower parts see "Room Air Blower"	
45091	Battery Box, Igniter (AA battery not included)
49090-2 (*8b)	Burner Tube, Ember (Front)
49090-1 (*8a)	Burner Tube, Main (Rear)
18253	Disc, High Limit (Spill, Auto Reset, L250-40F)
11450091	Gas Line, Flex, 3/8" Dia. x 24" (Pkg. of 4)
45062	Ground Wire 12" (For Igniter)
43022	Knob, Gas Shut-off Door
51132	Orifice Burner, (Propane) Propane, Front #66
49114	Orifice Burner, Natural Gas, Front #55
25093	Orifice, Burner (Propane) Propane, Rear #52
49113	Orifice, Burner Natural, Rear #33
75L1201	Orifice, Pilot (#51) - Natural Gas - Fits pilot P/N 42M2101 (new style) - see notes. ***
75L1301	Orifice, Pilot (#35) - Propane - Fits pilot P/N 42M2201 (new style) - see notes. ***
45143H	Orifice, Pilot (#51) - Natural Gas - Fits pilot P/N 45059H (old style) - see notes. **
45144	Orifice, Pilot (#35) - Propane - Fits pilot P/N 45063H (old style) - see notes. **
42M2101	Pilot Assembly, Natural Gas (new style w/detachable pilot hood. Fits all revisions of this model. Replaces P/N 45059H. Pilot includes pilot tube) ***
42M2201	Pilot Assembly, Propane (new style w/detachable pilot hood. Fits all revisions of this model. Replaces P/N 45063H. Pilot includes pilot tube) ***
26M76	Pilot Tube Kit, 24" (includes fittings)
00022H	Plug, Hole
45135	RB Regulator, 1.7 to 3.5" WC - Natural Gas (Controls flame height)
45136	RB Regulator, 6.3 to 10" WC - Propane (Controls flame height)
H0249	Remote Control, Standard, on/off, radio frequency (26N04, 40025000, 25050)
H0251	Remote Control, Deluxe w/thermostat, radio frequency (98K99, 3001)
45061	Switch, Battery (on valve)
410-270 (*1)	Switch, On/Off (Burner)
49119	Thermocouple, 24" / no pilot bracket fitting (provided on pilot bracket) (units mfg'r'd < 3/99)
32041	Thermocouple, 24" w/ pilot bracket fitting (units mfg'r'd > 3/99)
18050	Thermopile, 24"

89L36	Thermostat, Wall, MV (10NG4, 18120)
52L05 (*14)	Valve, Control, SIT - Natural Gas (25060)
10850057 (*14)	Valve, Control, SIT - Propane (25070)
51062	Wire Harness, Burner
45066	Wire, Igniter (24")
Room Air Blower	
49040 (*12)	Blower Kit, Room Air
15049 (*3)	Disc, Low Limit Disc (blower, F140°-20F)
527	Knob, Rheostat
51047 (*13)	Power Cord, Includes Wire Harness
528 (*2)	Rheostat w/ Connectors (knob not included)
Surround Parts	
2046	Bracket, Surround Trim (corner key / L bracket) - Order 2 if set is needed
49140	Conversion Kit, Natural Gas to Propane
49130	Conversion Kit, Propane to Natural Gas
49072S	Door, Gas Shut Off (on right surround panel) ①
51130	High Altitude Kit
43033	Magnetic Strip (for gas shut off door. Self adhesive) - Order 2 if set is needed
49070 (*11)	Surround Assembly 32 x 42" ①
32130	Trim, Gold Tone 32 x 42"
Miscellaneous Parts	
49023	Hinge, Side Door
49060-1	Louver Assembly, Front
70K99	Paint, Black Metallic (12 oz. spray #6309), 76-141MB
49020	Paint, Powder Coat Touch Up - 3 oz. Bottle (Read "CAUTION") ♦ ☒
49011-1	Top (Body Trim) 31 x 9 1/2" (requires two #8 x 1/2" Tek screws, not included) ①
Firebox & Log Parts	
88L53	Embers, Glowing, 1 oz. Bag (order a minimum of 10 for maintenance needs)
49035 (*10)	Log Set, 5 pc. Fiber (3-99 to present)
49033 (*9)	Log Set, 5 pc. Fiber (prior to 3-99)
49032H (*7)	Panel Set, 3 pc. Brick (Blond)

① Units shipped from the factory after 3/31/99 have painted body & surround components. Units shipped prior to 3/31/99 have a powdercoat finish. When ordering replacement parts with a powdercoat finish, add the letter "B" to the part number (i.e. 49070 is a surround with a painted finish, 49070B is a surround with a powdercoat finish).

♦ Units with a powdercoat touch-up can be identified by the work order number on body; work order numbers 886 and below are powdercoat, work order numbers 887 and above are painted.

☒ CAUTION: Only use powdercoat touch-up paint designed for powdercoat finishes. DO NOT use stove paint as touch-up on powdercoat finishes because it will cause a chemical reaction.

☒ Includes thermocouple, thermopile, pilot orifice, pilot tube and igniter electrode. The igniter wire, P/N 45066, is not included.

* The numbers in parenthesis correspond to the component diagrams on the following page(s).

** Fits pilot assemblies w/o a detachable pilot hood (the pilot tube fitting requires removal to install. Body of pilot hood does not have a visible clip).

*** Fits pilot assemblies w/detachable pilot hood (there is a visible clip on the body of the pilot hood which must not be removed when installing pilot orifice).

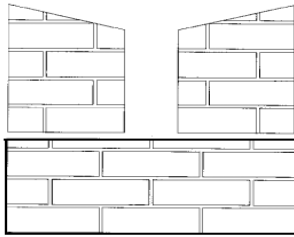

(7) BRICK PANEL SET



(9) LOG SET (FITS UNITS MANUFACTURED BEFORE 3/99)

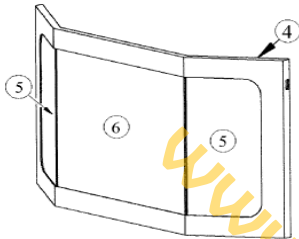

(4) DOOR ASSEMBLY



(10) LOG SET (FITS UNITS MANUFACTURED AFTER 3/99)

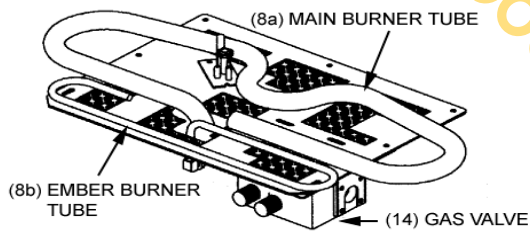

www.WoodHeatStoves.com

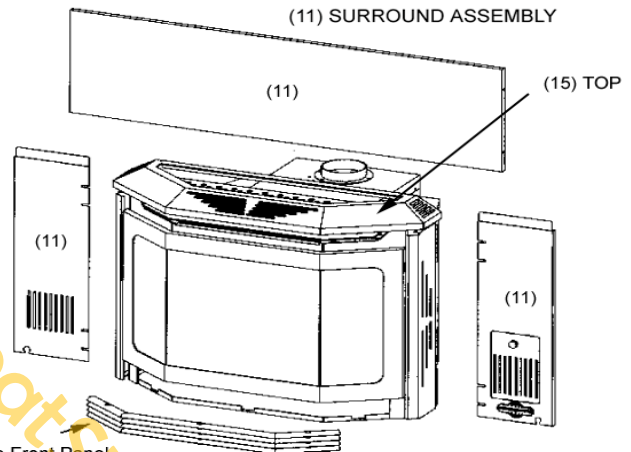

Remove Front Panel to Access Controls

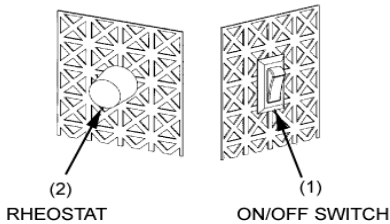

RHEOSTAT

ON/OFF SWITCH

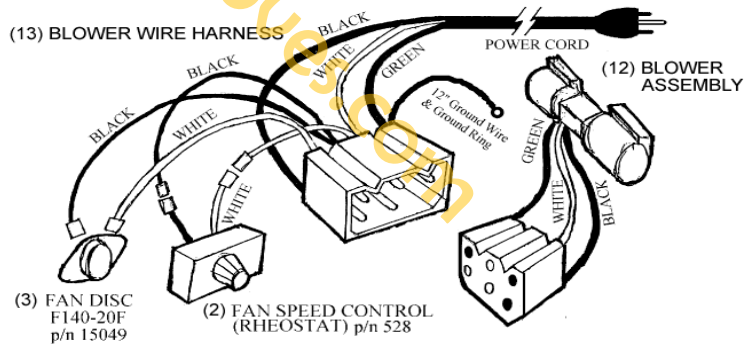

(13) BLOWER WIRE HARNESS

POWER CORD

(12) BLOWER ASSEMBLY

(3) FAN DISC F140-20F p/n 15049

(2) FAN SPEED CONTROL (RHEOSTAT) p/n 528

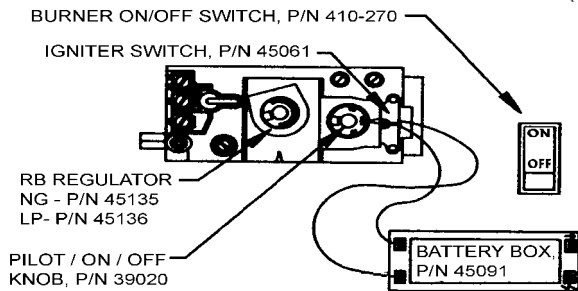

BURNER ON/OFF SWITCH, P/N 410-270

IGNITER SWITCH, P/N 45061

RB REGULATOR NG - P/N 45135 LP- P/N 45136

PILOT / ON / OFF KNOB, P/N 39020

BATTERY BOX, P/N 45091