

LENNOX HEARTH PRODUCTS**Service Replacement Parts List****Spectra CI1000HT Series (FS) / CI2000HT Series (FS)
H0354, H0355, H0356, H0357, H0358, H0359, H0360, H0361****MODEL YEARS: 2002 to 2008****Wood, Freestanding w/ Legs, 6" Flue, EPA phase 2, Residential Only**

ITEM NO	PART NO	DESCRIPTION
	Door & Glass Parts	
**	41M0101	Clip Set, Glass (Includes 4 Ea. Gaskets, Screws & Clips) - CI100* & CI200*
3	40M0701	Door, Ashpan, Charcoal (Handle Receiver Not Included) - CI1000
4	40M4301	Door, Ashpan, Charcoal (Handle Receiver Not Included) - CI2000
3	40M0601	Door, Ashpan, Cobalt Blue Enamel (Handle Receiver Not Included) - CI1002
4	40M7401	Door, Ashpan, Cobalt Blue Enamel (Handle Receiver Not Included) - CI2002
3	40M0501	Door, Ashpan, Hunter Green (Handle Receiver Not Included) - CI1004
4	40M7301	Door, Ashpan, Hunter Green (Handle Receiver Not Included) - CI2004
3	40M0401	Door, Ashpan, Ivory (Handle Receiver Not Included) - CI1006
4	40M4801	Door, Ashpan, Ivory. (Handle Receiver Not Included) - CI2006
1	40M1701	Door, Firebox, Charcoal (Handle Receiver Not Included) - CI1000
1	40M8201	Door, Firebox, Charcoal (Handle Receiver Not Included) - CI2000
1	40M1601	Door, Firebox, Cobalt Blue (Handle Receiver Not Included) - CI1002
**	N/A	Door, Firebox, Cobalt Blue (Handle Receiver Not Included) - CI2002, 41M8101
1	40M1501	Door, Firebox, Hunter Green (Handle Receiver Not Included) - CI1004
1	40M8001	Door, Firebox, Hunter Green (Handle Receiver Not Included) - CI2004
1	40M1401	Door, Firebox, Ivory (Handle Receiver Not Included) - CI1006
1	40M7901	Door, Firebox, Ivory (Handle Receiver Not Included) - CI2006
2	40M1201	Door, Side Loading, Charcoal (Handle Receiver Not Included) - CI1000
2	40M7801	Door, Side Loading, Charcoal (Handle Receiver Not Included) - CI2000
2	40M1101	Door, Side Loading, Cobalt Blue (Handle Receiver Not Included) - CI1002
2	40M7701	Door, Side Loading, Cobalt Blue (Handle Receiver Not Included) - CI2002
2	40M0901	Door, Side Loading, Hunter Green (Handle Receiver Not Included) - CI1004
2	40M7601	Door, Side Loading, Hunter Green (Handle Receiver Not Included) - CI2004
2	40M0801	Door, Side Loading, Ivory (Handle Receiver Not Included) - CI1006
2	40M7501	Door, Side Loading, Ivory (Handle Receiver Not Included) - CI2006
**	40M5401	Glass, Replacement, 10.39" X 14.02" (Includes Gasket) - CI100*
**	41M0801	Glass, Replacement, 18.82" X 12.52" (Includes Gasket) - CI200*
24	40M5301	Hinge Pin Set, Ashpan Door (Includes Acorn Nuts & Washers) - CI100* & CI200*
25	40M4101	Hinge Pin Set, Firebox Door (Includes Acorn Nuts & Washers) - CI100*
26	40M5601	Hinge Pin Set, Firebox Door (Includes Acorn Nuts & Washers) - CI200*
27	40M5801	Hinge Pin Set, Side Door (Includes Acorn Nuts & Washers) CI100* & CI200*
42	40M5201	Receiver Assembly, Ashpan Door Handle (Includes Latch) - CI100*
42	40M0301	Receiver Assembly, Ashpan Door Handle (Includes Latch) - CI200*
42	40M1001	Receiver Assembly, Firebox Door Handle (Includes Latch) - CI100* & CI200*
42	40M3801	Receiver Assembly, Side Door Handle (Includes Latch) - CI200*
42	40M6101	Receiver Assembly, Side Door Handle (Includes Latch) - CI100*

ITEM NO	PART NO	DESCRIPTION
Cast Body Parts		
35	40M8601	Ashlip, Charcoal, Painted (Includes Screws) - CI2000
35	40M2101	Ashlip, Charcoal, Painted (Includes Gasket & Screws) - CI1000
35	40M8501	Ashlip, Cobalt Blue Enamel (Includes Gasket & Screws) - CI2002
35	40M2001	Ashlip, Cobalt Blue Enamel (Includes Gasket & Screws) - CI1002
35	40M8401	Ashlip, Hunter Green Enamel (Includes Gasket & Screws) - CI2004
35	40M1901	Ashlip, Hunter Green Enamel (Includes Gasket & Screws) - CI1004
35	40M8301	Ashlip, Ivory Enamel (Includes Gasket & Screws) - CI2006
35	40M1801	Ashlip, Ivory Enamel (Includes Gasket & Screws) - CI1006
40	40M9001	Collar Kit, Charcoal Replacement Flue (Includes Gasket & Hardware) - CI2000
39	40M2701	Collar Kit, Charcoal Replacement Flue (Includes Gasket & Hardware) - CI1000
40	40M8901	Collar Kit, Cobalt Blue Enamel Replacement Flue (Includes Gasket & Hardware) - CI2002
39	40M2601	Collar Kit, Cobalt Blue Enamel Replacement Flue (Includes Gasket & Hardware) - CI1002
40	40M8801	Collar Kit, Hunter Green Enamel Replacement Flue (Includes Gasket & Hardware) - CI2004
39	40M2501	Collar Kit, Hunter Green Enamel Replacement Flue (Includes Gasket & Hardware) - CI1004
40	40M8701	Collar Kit, Ivory Enamel Replacement Flue (Includes Gasket & Hardware) - CI2006
39	40M2401	Collar Kit, Ivory Enamel Replacement Flue (Includes Gasket & Hardware) - CI1006
28	41M0701	Leg, Front Left, Blue (Includes Gasket & Hardware) - CI1002 & CI2002
28	41M0901	Leg, Front Left, Charcoal (Includes Gasket & Hardware) - CI1000 & CI2000
28	41M0001	Leg, Front Left, Green (Includes Gasket & Hardware) - CI1004 & CI2004
28	40M9901	Leg, Front Left, Ivory (Includes Gasket & Hardware) - CI1006 & CI2006
28	40M9401	Leg, Front Right, Blue (Includes Gasket & Hardware) - CI1002 & CI2002
28	40M9501	Leg, Front Right, Charcoal (Includes Gasket & Hardware) - CI1000 & CI2000
28	40M9201	Leg, Front Right, Green (Includes Gasket & Hardware) - CI1004 & CI2004
28	40M9101	Leg, Front Right, Ivory (Includes Gasket & Hardware) - CI1006 & CI2006
28	41M3101	Leg, Right & Left Rear, Charcoal (Includes Gasket & Hardware) - CI1000 & CI2000
28	41M2901	Leg, Right & Left Rear, Green (Includes Gasket & Hardware) - CI1004 & CI2004
28	41M2801	Leg, Right & Left Rear, Ivory (Includes Gasket & Hardware) - CI1006 & CI2006
28	41M3001	Leg, Right & Left Rear, Blue (Includes Gasket & Hardware) - CI1002 & CI2002
Misc. Parts		
47	40M3501	Draft Module, Air Intake (Slide Assembly) Includes Gasket & Hardware - CI100*
48	41M0201	Draft Module, Air Intake (Slide Assembly) Includes Gasket & Hardware - CI200*
**	40M6701	Paint, Touch-Up (Tube, Cobalt Blue Enamel) One Tube. <i>Note: Order 40M6701 for a case Of 14 Tubes - CI1002 & CI2002</i>
**	40M6601	Paint, Touch-Up (Tube, Hunter Green Enamel) One Tube <i>Note: Order 40M6601 for a case of 14 Tubes - CI1004 & CI2004</i>
**	40M6501	Paint, Touch-Up (Tube, Ivory Enamel) One Tube <i>Note: Order 40M6501 for a case of 14 Tubes - CI1006 & CI2006</i>
**	H7176	Paint, Touch-Up Spray (Spray, Charcoal, One Spray Can) <i>Note: Order 40M6801 for a case of 12 cans - CI1000 & CI2000</i>
41	40M6201	Poker, Fire CI100* & CI200*
Miscellaneous Parts		
**	40M3601	Back, Steel Stove (Includes Hardware) - CI100*
**	41M0301	Back, Steel Stove (Includes Hardware) - CI200*
45	41M1001	Tool, Ashpan Removal / Air Control - CI100* & CI200*
46	40M5501	Tool, Removable Door Opener - CI100* & CI200*
Gasket Kits		
**	40M4501	Gasket Kit, 6 Mm X 156cm (14979) For Air Intake Slide & Glass & 4 ea. 6mm Glass Clip Gaskets (31856) - CI100* & CI200*
48	40M0201	Gasket Kit, Ashpan Door Rope (8mm Dia. X 97 cm) - CI100*
**	40M4201	Gasket Kit, Rope (10mm Dia. X 146cm) Ashpan Door - CI200*HT, Side & Front Firebox Door - CI100*HT
**	40M4401	Gasket Kit, Rope (12mm Dia. X 177 cm) Front & Side Door - CI200*
19	40M4901	Gasket Set, Air Column, 70mm X 45mm (Also Includes Start Up Air Channel for Model CI200*HT) - CI100* & CI200*
**	41M3601	Gasket, Flue Outlet - CI100*

ITEM NO	PART NO	DESCRIPTION
Firebox Parts		
31	40M5701	Air Column Set, Left & Right (Includes Gaskets & Screws) - CI100*
32	40M6901	Air Column Set, Left & Right (Includes Gaskets & Screws) - CI200*
34	40M9801	Air Deflector (Air Wash), Upper (Includes Hardware) - CI200*
33	40M2301	Air Deflector (Air Wash), Upper (Includes Hardware) - CI100*
36	40M3901	Ashpan Assembly - CI100*
36	41M0501	Ashpan Assembly - CI200*
37	40M5101	Baffle, Firebox (Baffle Box, Ceramic) - CI200*
38	41M0401	Channel Assembly, Start-Up Air (Includes Gasket And Hardware) - CI200*
5	41M5501	Firebrick, Bottom Central -CI200*
6	41M4901	Firebrick, Bottom Side (requires 2) - CI200*
12	41M3901	Firebrick, Left - CI100*
7	41M5001	Firebrick, Left Side Lower - CI200*
8	41M5101	Firebrick, Left Side Upper - CI200*
9	41M5401	Firebrick, Lower Rear - CI200*
13	41M3801	Firebrick, Lower Rear - CI100*
14	41M4001	Firebrick, Right - CI100*
10	41M5201	Firebrick, Right Side Lower - CI200*
15	41M3701	Firebrick, Upper Front - CI100*
16	41M4101	Firebrick, Upper Rear -CI100*
11	41M5301	Firebrick, Upper Rear - CI200*
17	40M7201	Frame, Fuel Grate -CI100*
18	40M9301	Frame, Fuel Grate - CI200*
20	40M4001	Grate Support Bar, Fuel - CI100*
21	40M1301	Grate, Ash Removal - CI100*
22	40M2901	Grate, Fuel - CI100*
23	40M9601	Grate, Fuel - CI200*
29	40M2801	Log Guard (W/ 2 Andirons) - CI100*
30	40M9701	Log Guard (W/ 3 Andirons) -CI200*
49	41M5601	Retainer Set, Firebrick (Includes Hardware) -CI200*
**	41M4201	Retainer, Firebrick Steel - CI100*
43	40M6001	Secondary Air Tube Kit (Includes Screws) - CI100*
44	40M0101	Secondary Air Tube Kit (Includes Screws & Washers) - CI200*
**	41M0601	Tube, Front Air Feed - CI200*



** = No picture

Model Designations Summary:

CI100*HT = Mid Sized Unit

CI200*HT = Lg. Sized Unit

* The 4th number indicated by an asterisk indicates the body finish. If an asterisk is in place of the digit in column D, then kit is compatible with all finishes:

0 = Charcoal, Painted, 2 = Cobalt Blue, Enamel, 4 = Hunter Green, Enamel, 6 = Ivory, Enamel

Item number preceding the part number corresponds to the following component diagrams

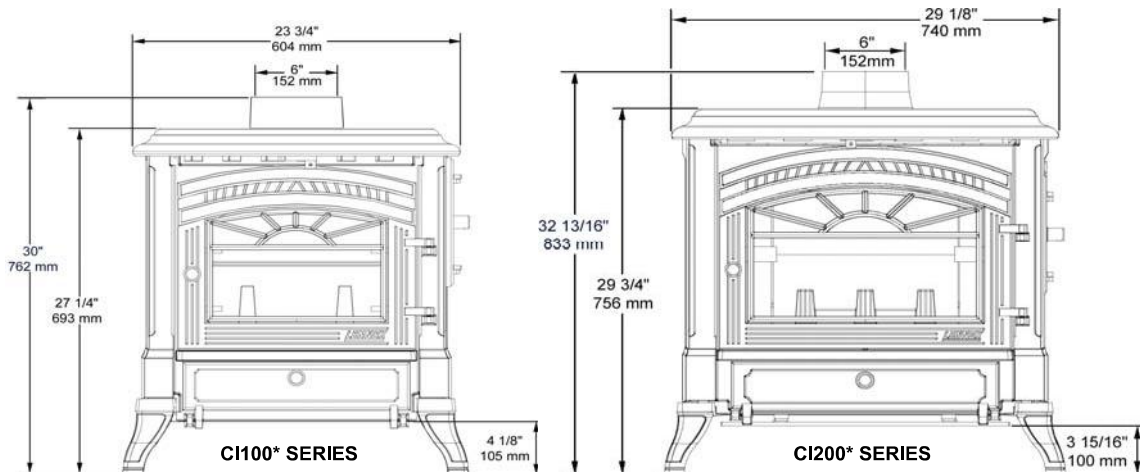

(+1) Front Firebox Door
(CI1000HT & CI2000HT Series)

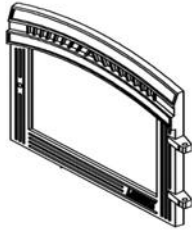

(+2) Side Loading Door
(CI1000HT Series)

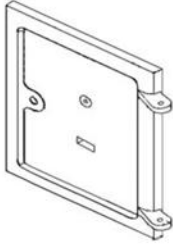

(+2) Side Loading Door
(CI2000HT Series)

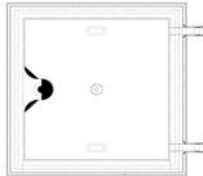

(+3) Ashpan Door
(CI1000HT Series)

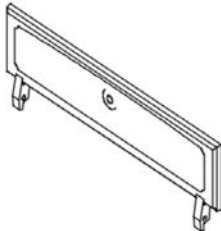

(+4) Ashpan Door
(CI2000HT Series)



(+5) Bottom Center Firebrick
(CI2000HT Series)

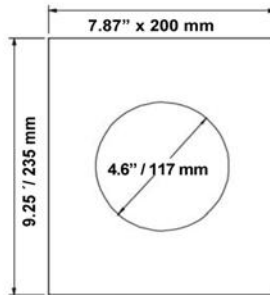

(+7) Left Lower Firebrick
(CI2000HT Series)
7.87" / 200 mm

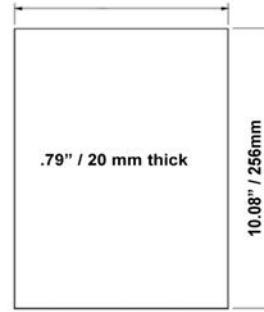

(+8) Upper Left Firebrick
(CI2000HT Series)
10.43" / 265 mm

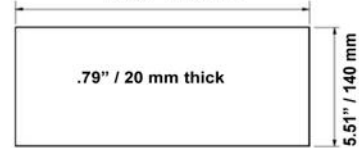

(+6) Bottom Side Firebrick
(CI2000HT Series)

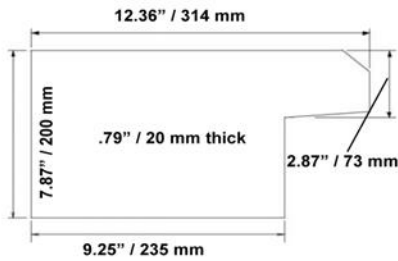

(+9) Lower Rear Firebrick
(CI2000HT Series)

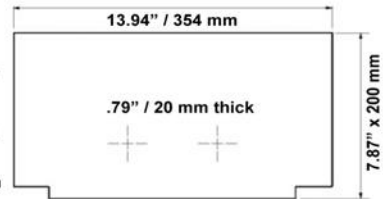

(•10) Right Lower Firebrick
(CI2000HT Series)

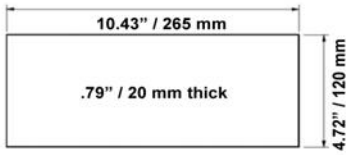

(•11) Upper Rear Firebrick
(CI2000HT Series)

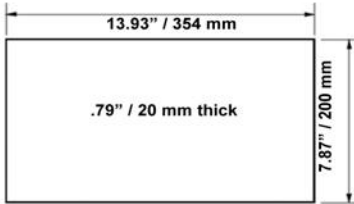

(•12) Left Firebrick
(CI1000HT Series)

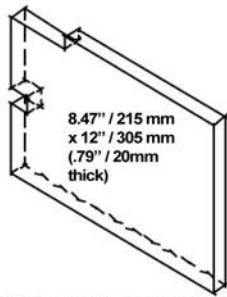

(•13) Lower Rear Firebrick
(CI1000HT Series)

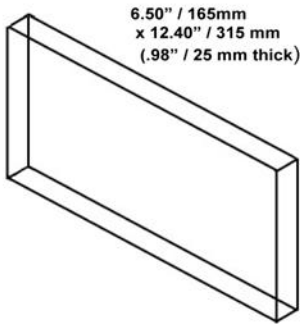

(•14) Right Firebrick
(CI1000HT Series)

8.47\"/>



(•15) Baffle Firebrick
(above tubes on ceiling)
(CI1000HT Series)

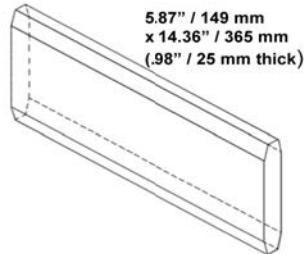

(•16) Upper Rear Firebrick
(CI1000HT Series)

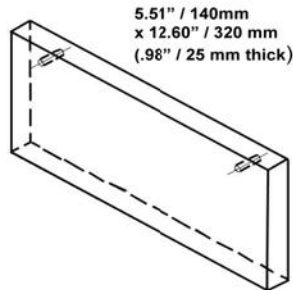

(•17) Fuel Grate Frame
(CI1000HT Series)

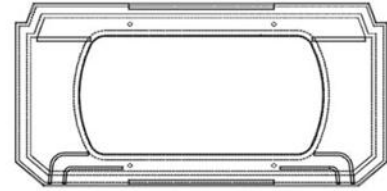

(•18) Fuel Grate Frame
(CI2000HT Series)

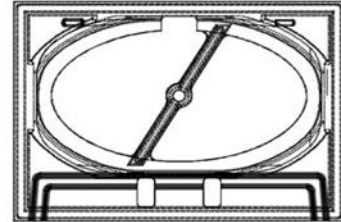

(•19) Air Column Gasket
(CI1000HT & CI2000HT Series)

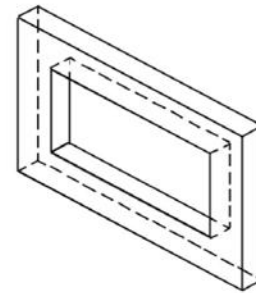

(•19) Start-up Air Column Gasket
(CI2000HT Series)

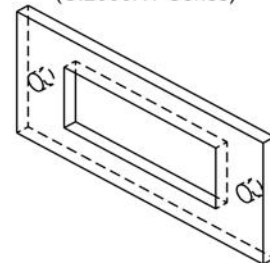

(•20) Fuel Grate Support Bar
(CI1000HT Series)



(•21) Ash Removal Grate
(CI1000HT Series)

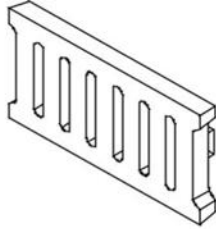

(•22) Fuel Grate
(CI1000HT Series)

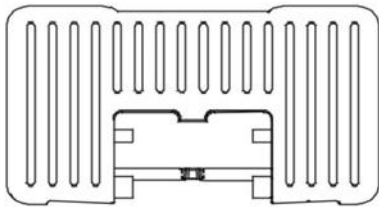

(•23) Fuel Grate
(CI2000HT Series)

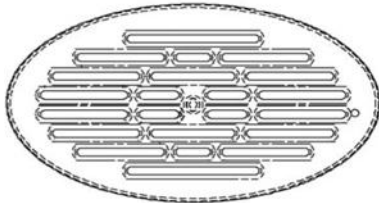

(•24) Ashpan Door Hinge Pin
(CI1000HT & CI2000HT Series)



(•25) Front Firebox Door Hinge Pin
(CI1000HT Series)



(•26) Front Firebox Door Hinge Pin
(CI2000HT Series)



(•27) Side Door Hinge Pin
(CI1000HT & CI2000HT Series)



(•28) Stove Leg
(CI1000HT & CI2000HT Series)

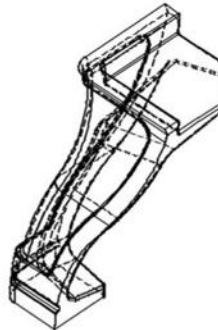

(•29) Log Guard
(CI1000HT Series)

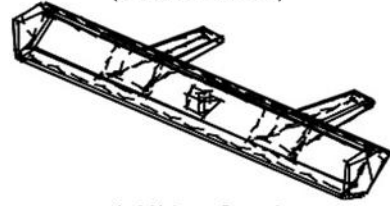

(•30) Log Guard
(CI2000HT Series)

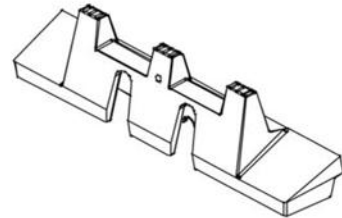

(•31) Left Air Column Assembly
(CI1000HT Series)

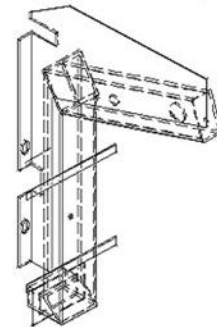

(•31) Right Air Column Assembly
(CI1000HT Series)

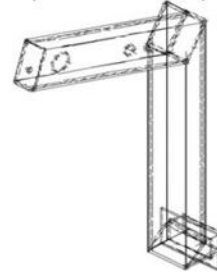

(•32) Left Air Column Assembly
(CI2000HT Series)

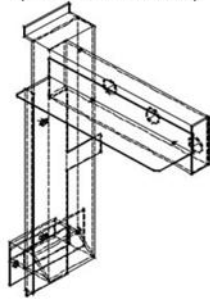

(•32) Right Air Column Assembly
(CI2000HT Series)

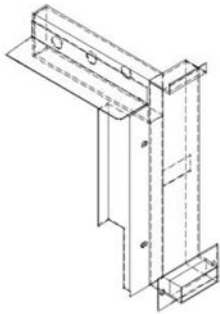

(•33) Upper Air Deflector
(CI1000HT Series)

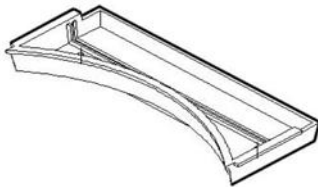

(•34) Upper Air Deflector
(CI2000HT Series)

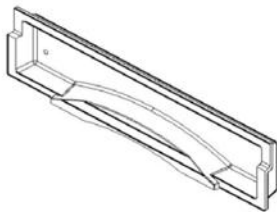

(•35) Ashlip
(CI1000HT & CI2000HT Series)



(•36) Ashpan
(CI1000HT & CI2000HT Series)

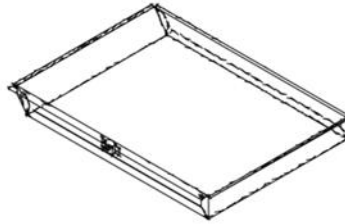

(•37) Baffle Assembly, Ceramic Fiber
Brick (above secondary air tubes)
(CI2000HT Series)

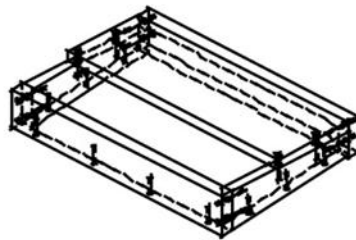

(•38) Start-up Air Channel Assembly
(CI2000HT Series)



(•39) Flue Outlet Collar
(CI1000HT Series)

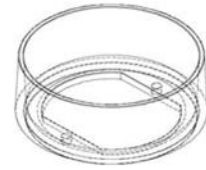

(•40) Flue Outlet Collar
(CI2000HT Series)

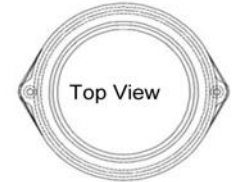
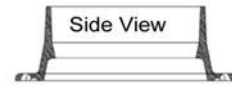

(•41) Fire Poker
(CI1000HT & CI2000HT Series)



(•42) Ashpan, Side Door and Firebox
Door Handle Receivers
(CI1000HT & CI2000HT Series)

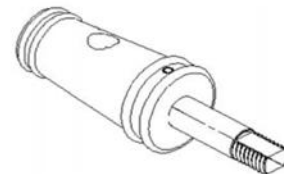

(+43) Secondary Air Tube Assembly
(CI1000HT Series)

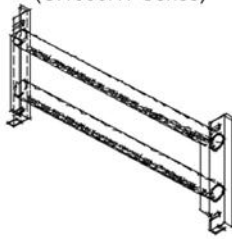

(+45) Air Control/Ash Pan Removal Tool
(CI1000HT & CI2000HT Series)

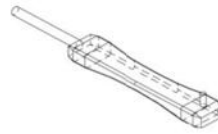

(+48) Draft Module (Air Intake Slide)
(CI2000HT Series)

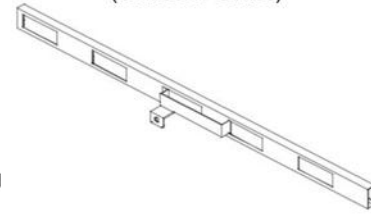

(+46) Removable Door Opener Tool
(CI1000HT & CI2000HT Series)



(+44) Secondary Air Tube Assembly
(CI2000HT Series)

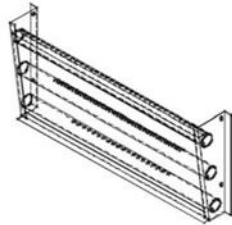

(+47) Draft Module (Air Intake Slide)
(CI1000HT Series)

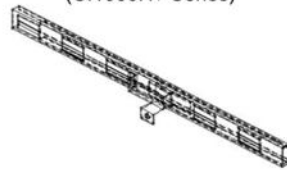

(+49) Rear Firebrick Retainers
(CI2000HT Series)
Side Retainers Not Shown

