











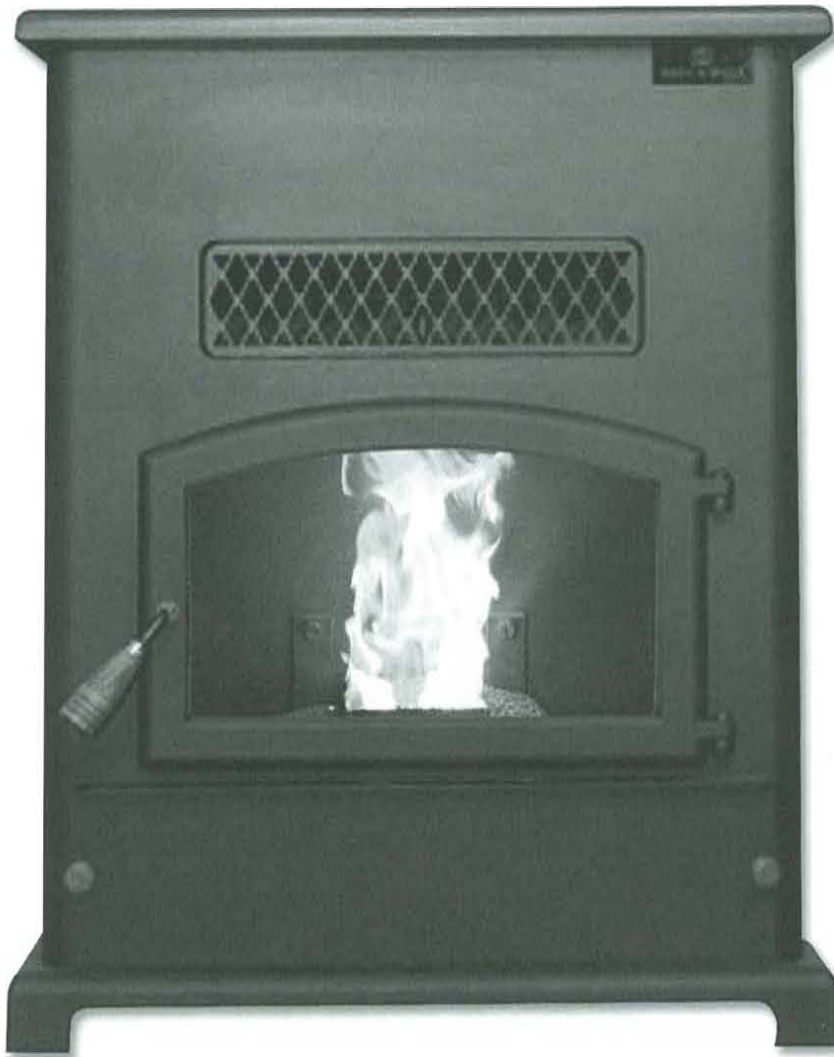

Table of Contents

	Big E P10004-5		Mojave P2700 FS16-17
	Blazer P24 FS6-7		Solstice P7000 FS18-19
	Classic Cast P4000 FS8-9		Sonora P23 FS20-21
	Heartland Multi-Fuel P6000 FS10-11		Tahoe P2000 FS22-23
	Mahogany Wood Stove W310012-13		Window Unit SP800024-25
	Maverick P22 FS14-15		Universal Parts26-27

BIG E
BLAZER
CLASSIC CAST
HEARTLAND
MAHOAGANY
MAVERICK
MOJAVE
SOLSTICE
SONORA
TAHOE
WINDOW
UNIVERSAL

Big E P1000



Up to 47,000 BTUs: Providing comforting heat from 400 sq. ft. to up to 2200 sq. ft. Remote and wall Thermostat compatible. 5 heat settings.

The Automatic Fuel Feed lets you burn up to 140 hours on each load with the huge 140 lb. hopper fuel capacity.

Heavy steel construction provides long-term reliability and durability.

One touch digital technology control board with multiple safety checks and diagnostics; extending the life and efficiency of your stove.

The "Hot Rod" Automatic Fire Starter igniter assures the stove lights quickly and safely. No messy starter gels needed.

Stainless steel burn pot. Removable for easy cleaning.

Large and easily accessible ash drawer (available on select models).

Special air wash system helps keep glass clean.

Limited 5 year warranty. 1 year electrical.

Options

Hopper extension: an additional 210 lbs.

Remote Control Thermostat: Radio Controlled with range up to 100 ft.

Specifications

Weight: 220 lbs.

Burn Time: Up to 140 hours

Max BTU: 47,000

Sq. Ft. Range: 400-2200

EPA: Exempt-Washington state approved

Dimensions

Width: 25.75 inch

Depth: 23.875 inch

Height: 32.625 inch

Hopper Capacity: Up to 140 lbs.

Standard

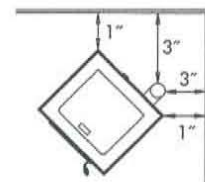
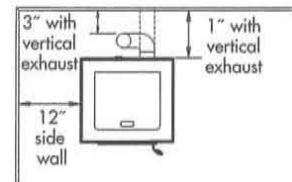

Approved Installation: Alcove, Mobile Homes & Conventional

Big E P1000

Parts No.	Description
C-E-201	Air Switch
C-M-340-T	(891121) Air Switch Tube (Per Foot)
C-S-1060	Ash Cleanout Door
A-S-3018	Auger Biscuit, Octagon – Includes A-BUSHTOP & C-F-088
A-BUSHTOP	Auger Bushing – Top & Bottom, Brass (No Threads)
C-S-1078	Auger Cover Plate
C-E-017	Auger Motor
A-AUGPIN	(83529) Auger Pin
A-AUG-22	Auger Shaft
C-S-3030	Auger Stop Bracket
A-S-BURNPOT	Burnpot Assembly – Includes A-S-INSERT
A-S-INSERT	Burnpot Insert – Stainless Steel
A-TOOL-96	Cleaning Tool
A-E-027	Combustion Blower
A-E-033A	Convection Blower, with Gasket

Parts No.	Description
C-E-046-N	Fuse – 125V 5 AMP
C-G-105	Gasket, Combustion Blower – Housing to Motor
C-G-101	Gasket, Combustion Blower – Housing to Stove
C-G-100	Gasket, Convection Blower
C-G-050	(88066) Gasket, Door – 5/8" Firm Black
C-G-033	Gasket, Glass – 3/16" x 3/8" (10 ft. Package)
C-F-370	Grommet, Rubber – Damper
C-E-IGN	Igniter Element
C-E-060	Power Cord
C-E-071	Receptacle for Power Cord
AG-RCN	Remote Thermostat – Accumen
C-F-088	Retaining Ring – 5/8" – For A-BUSHTOP
C-E-090-21	Thermodisc, High Limit
C-E-090-22C	Thermodisc, Proof of Fire/Low Limit
C-E-UH1000	Wiring Harness, Universal for Digital Control Panel

Parts No.	Description
A-ASHPANBIGE	Ash Pan – Big E
C-S-4084	Cam Latch – P22, P1000PB, P4000
C-S-4080	Cam Latch – P23, P1000PWA, P24
C-S-999	Combustion Blower Transition – Aluminum
A-E-401	Control Panel, Digital
C-L-401	Control Panel Faceplate for A-E-401
A-DOORMULTIUSE	Door - P1000, PCA/PCNA Version, P4000 (PCA/PCNA)
A-DOORP22-BN	Door - P22, P1000PW - Brushed Nickel (PW)
A-DOORP22-P	Door – P22, P1000PW – Painted (PW)
A-D-018-C	Door - P23, P1000PWA, Painted (PWA)
C-F-091	Door Hinge Pin
C-D-038	(891979) Glass, Half Oval – P23, P1000PWA
C-D-1100	Glass, P1000PB
C-M-066	(891148) Handle – Pocket Pull For Hopper Lid
A-H-KIT23	Handle Replacement Kit - P23, P24, P1000PWA/PWC
A-H-KITCAST	Handle Replacement Kit – P1000PCA/PCNA, P4000
C-F-291	Hinge Block (PWA/PCA & PCNA)
A-HINGEBASIC	Hinge, Door - P22, P1000PB, P1000PW (PB/PW)
A-PIK-EXT	Hopper Extension - P1000
C-S-11115	Hopper Lid - P1000 - Original Style
C-E-901	Hopper Switch - Big E
C-S-11095	Panel, Left Side - P1000
C-S-11105	Panel, Rear - P1000
C-S-11100	Panel, Right Side - P1000

Blazer P24 FS



Up to 50,000 BTUs: Providing comforting heat from 400 sq. ft. to up to 2200 sq. ft. Remote and wall Thermostat compatible. 5 heat settings.

The Automatic Fuel Feed lets you burn up to 60 hours on each load with the 60 lb. hopper fuel capacity.

Heavy steel construction provides long-term reliability and durability.

One touch digital technology control board with multiple safety checks and diagnostics; extending the life and efficiency of your stove.

The "Hot Rod" Automatic Fire Starter igniter assures the stove lights quickly and safely. No messy starter gels needed.

Stainless steel burn pot. Removable for easy cleaning.

Special air wash system helps keep glass clean.

Limited 5 year warranty. 1 year electrical.

Freestanding Only

Large and easily accessible ash drawer.

Easy access rear, and swing-open side panels for quick maintenance and service.

Top or rear exhaust capable.

Options

Remote Control Thermostat: Radio Controlled with range up to 100 ft.

Door: Gold plated, gold trim, or brushed nickel.

Cowl: Gold plated, or brushed nickel.

Specifications

Weight: 280 lbs.

Burn Time: Up to 60 hours

Max BTU: 50,000

Sq. Ft. Range: 400-2200

EPA: Exempt-Washington state approved

Dimensions

Width: 26 inch

Depth: 31 inch w/ash lip

Height: 33.5 inch

Hopper Capacity: Up to 60 lbs.

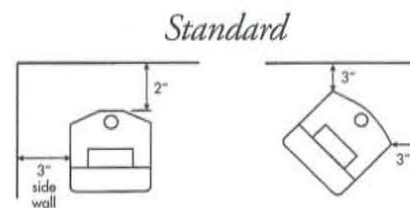
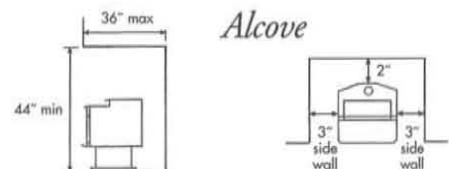

Approved Installation: Alcove, Mobile Homes & Conventional

Parts No.	Description
C-E-201	Air Switch
C-M-340-T	(891121) Air Switch Tube (Per Foot)
C-S-1060	Ash Cleanout Door
A-S-3018	Auger Biscuit, Octagon – Includes A-BUSHTOP & C-F-088
A-BUSHTOP	Auger Bushing – Top & Bottom, Brass (No Threads)
C-S-1078	Auger Cover Plate
C-E-017	Auger Motor
A-AUGPIN	(83529) Auger Pin
A-AUG-22	Auger Shaft
C-S-3030	Auger Stop Bracket
A-S-BURNPOT	Burnpot Assembly – Includes A-S-INSERT
A-S-INSERT	Burnpot Insert – Stainless Steel
A-TOOL-96	Cleaning Tool
A-E-027	Combustion Blower
A-E-033A	Convection Blower, with Gasket

Parts No.	Description
A-ASHPANP24FS	Ash Pan – P24F
A-M-BRICK24	Brick Panels – P24F
A-M-BRICK24I	Brick Panels – P24I
A-M-LOG	Ceramic Log
C-S-4080	Cam Latch – P23, P1000PWA, P24
A-E-401	Control Panel, Digital
C-L-401	Control Panel Faceplate for A-E-401
A-D-010-BN	Door - P24, Brushed Nickel
A-D-010-G	Door - P24, Gold
A-D-010-PT	Door - P24, Painted w/Trim
C-D-050N	Door Handle, Spring – Chrome
C-D-050	(892002) Door Handle, Spring – Gold
C-F-091	Door Hinge Pin
C-D-030	Glass, Oval
C-D-032	Glass, Side
A-H-KIT23	Handle Replacement Kit - P23, P24, P1000PWA/PV
C-F-291	Hinge Block
C-S-5040	Hopper Lid - P24F
C-S-323	Hopper Lid - P24I
A-S-103-BN	Window Trim, Side - P24I - Brushed Nickel
A-S-103-G	Window Trim, Side - P24I - Gold
A-S-103	Window Trim, Side - P24I - Painted

Parts No.	Description
C-E-046-N	Fuse – 125V 5 AMP
C-G-105	Gasket, Combustion Blower – Housing to Motor
C-G-101	Gasket, Combustion Blower – Housing to Stove
C-G-100	Gasket, Convection Blower
C-G-050	(88066) Gasket, Door – 5/8" Firm Black
C-G-033	Gasket, Glass – 3/16" x 3/8" (10 ft. Package)
C-F-370	Grommet, Rubber – Damper
C-E-IGN	Igniter Element
C-E-060	Power Cord
C-E-071	Receptacle for Power Cord
AG-RCN	Remote Thermostat – Accumen
C-F-088	Retaining Ring – 5/8" – For A-BUSHTOP
C-E-090-21	Thermodisc, High Limit
C-E-090-22C	Thermodisc, Proof of Fire/Low Limit
C-E-UH1000	Wiring Harness, Universal for Digital Control Panel

Classic Cast P4000 FS



Up to 42,000 BTUs; Providing comforting heat from 400 sq. ft. to up to 2000 sq. ft. Remote and wall Thermostat compatible. 4 heat settings.

The Automatic Fuel Feed lets you burn up to 50 hours on each load with the 50 lb. hopper fuel capacity.

Classic Cast Iron Construction provides long-term reliability and durability.

Radiant and forced air heat.

One touch digital technology control board with multiple safety checks and diagnostics; extending the life and efficiency of your stove.

The "Hot Rod" Automatic Fire Starter igniter assures the stove lights quickly and safely. No messy starter gels needed.

Stainless steel burn pot. Removable for easy cleaning.

Easily accessible ash pan.

Special air wash system helps keep glass clean.

Limited 5 year warranty. 1 year electrical.

Options

Remote Control Thermostat: Radio Controlled with range up to 100 ft.

Door: Gold plated or brushed nickel

Sunburst glass accent trim.

Realistic ceramic log set.

Specifications

Weight: 290 lbs.

Burn Time: Up to 50 hours

Max BTU: 42,000

Sq. Ft. Range: 400-2000

EPA: Exempt-Washington state approved

Dimensions

Width: 25.25 inch

Depth: 24.25 inch

Height: 29.5 inch

Hopper Capacity: Up to 50 lbs.

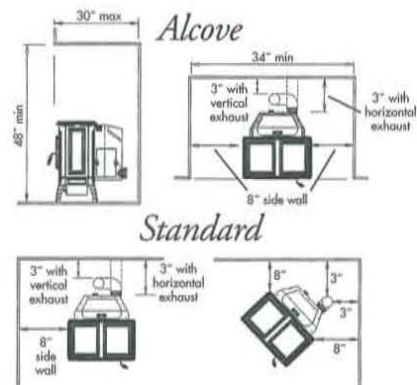

Approved Installation: Alcove, Mobile Homes & Conventional

Classic Cast P4000 FS

Parts No.	Description
C-E-201	Air Switch
C-M-340-T	(891121) Air Switch Tube (Per Foot)
C-S-1060	Ash Cleanout Door
A-S-3018	Auger Biscuit, Octagon — Includes A-BUSHTOP & C-F-088
A-BUSHTOP	Auger Bushing — Top & Bottom, Brass (No Threads)
C-S-1078	Auger Cover Plate
C-E-017	Auger Motor
A-AUGPIN	(83529) Auger Pin
A-AUG-22	Auger Shaft
C-S-3030	Auger Stop Bracket
A-S-BURNPOT	Burnpot Assembly — Includes A-S-INSERT
A-S-INSERT	Burnpot Insert — Stainless Steel
A-TOOL-96	Cleaning Tool
A-E-027	Combustion Blower
A-E-033A	Convection Blower, with Gasket

Parts No.	Description
C-E-046-N	Fuse — 125V 5 AMP
C-G-105	Gasket, Combustion Blower — Housing to Motor
C-G-101	Gasket, Combustion Blower — Housing to Stove
C-G-100	Gasket, Convection Blower
C-G-050	(88066) Gasket, Door — 5/8" Firm Black
C-G-033	Gasket, Glass — 3/16" x 3/8" (10 ft. Package)
C-F-370	Grommet, Rubber — Damper
C-E-IGN	Igniter Element
C-E-060	Power Cord
C-E-071	Receptacle for Power Cord
AG-RCN	Remote Thermostat — Accumen
C-F-088	Retaining Ring — 5/8" — For A-BUSHTOP
C-E-090-21	Thermodisc, High Limit
C-E-090-22C	Thermodisc, Proof of Fire/Low Limit
C-E-UH1000	Wiring Harness, Universal for Digital Control Panel

Parts No.	Description
A-ASHPANCAST	Ash Pan — P4000
C-S-4170	Baffle, Top Plate
A-M-BRICK22	Brick Panels — P22, P4000
A-M-LOG	Ceramic Log
C-S-4084	Cam Latch — P22, P1000PB, P4000
C-S-999	Combustion Blower Transition — Aluminum
A-E-101	Control Panel, Digital
C-L-101	Control Panel Faceplate for A-E-101
A-DOORMULTIUSE	Door - P1000, PCA/PCNA Version, P4000
C-F-091	Door Hinge Pin
A-H-KITCAST	Handle Replacement Kit — P1000PCA/PCNA, P4000
C-S-12100	Panel, Front, Cast - P4000
C-S-12035	Panel, Rear - P4000
C-S-12105	Panel, Side, Cast End - P4000 (Left or Right)

Heartland Multi-Fuel P6000



Up to 45,000 BTUs: Providing comforting heat from 400 sq. ft. to up to 2200 sq. ft. Remote and wall Thermostat compatible. 5 heat settings.

The Automatic Fuel Feed lets you burn up to 40 hours on each load of up to 85 lbs. of dried corn, or up to 45 hours with up to 75 lbs. of wood pellet fuel capacity.

Burns corn and wood pellets.

Heavy steel construction provides long-term reliability and durability.

One touch digital technology control board with multiple safety checks and diagnostics; extending the life and efficiency of your stove.

Control Panel is mounted at the top of the unit for easy access. It is also designed so that it can be mounted either back center, or back left.

Stainless steel burn pot. Removable for easy cleaning.

Large and easily accessible ash drawer.

Special air wash system helps keep glass clean.

Decorative brick-look panels included.

Limited 5 year warranty. 1 year electrical.

Options

Remote Control Thermostat: Radio Controlled with range up to 100 ft.

Gold plated or brushed nickel doors and cowls.

Specifications

Weight: 265 lbs.

Burn Time: Up to 45 hours

Max BTU: 45,000

Sq. Ft. Range: 400-2200

EPA: Exempt

Dimensions

Width: 27.25 inch

Depth: 32 inch (w/ash lip)

Height: 37.75 inch

Hopper Capacity: Up to 85 lbs.

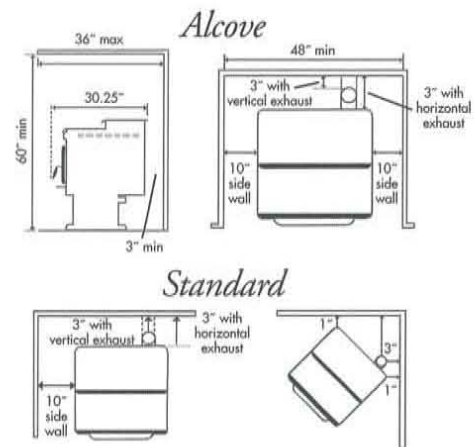

Approved Installation: Alcove, Mobile Homes & Conventional

Heartland Multi-Fuel P6000

Parts No.	Description
C-E-201	Air Switch
C-M-340-T	(891121) Air Switch Hose
C-E-010	Auger Motor
A-S-MULTIPOT	Burn Pot
A-E-4200	Control Panel
A-E-028	Combustion Blower
A-E-033A	Convection Blower
C-G-050	(88066) Door Gasket
C-D-031	Door Glass
A-4-VA	Exhaust Adaptor 4"
C-E-900	Hopper Lid Switch
A-S-TOOL	Maintenance Tool
C-E-015	Stir Motor
A-S-MULTISTIR	Stir Rod
C-E-090-21	Thermodisc— High Temp.
C-E-090-22C	Thermodisc— POF
C-G-033	Window Gasket (10 ft. piece)
C-E-UH1000	Wiring Harness, Main
C-E-UH1001	Wiring Harness Ext. 6" White
C-E-UH1002	Wiring Harness Ext. 26" White
C-E-UH1003	Wiring Harness Ext. 26" Purple

Mahogany W3100



Specifications

Weight: 430 lbs.

Burn Time: Up to 7-9 hours

Max BTU: 37,000

Max Sq. Ft. Range: 1800

Max Log Size: 18 inch

Flue Outlet: 6 inches

Dimensions

Width: 25 inch

Depth: 22.5 inch

Height: 39 inch with
log storage pedestal
33 inch with
standard pedestal

EPA: Certified

Up to 37,000 BTUs for comforting heat from 400 sq. ft. to up to 1800 sq. ft.

Holds logs of up to: 18 inch

2.1 cubic foot firebox.

Cleverly designed to be used as an insert or a freestander. You can take your stove with you if you move and it can be installed according to your changing needs.

The Unique Four-way Radiant and convection Air Heat Systems assures even and consistent heat distribution.

The 1/4" rugged steel construction is nearly indestructible, and the components are exceedingly reliable and durable.

Large glass and heavy duty cast iron door.

Front top can be used as a steamer or a cooking area.

Meets or exceeds all safety regulations. Built with a special dual-level steel bottom.

Limited 5 year warranty. 1 year electrical.

Options

The Crossflow blower is durable and quiet.

Freestanding Models Only:

Painted cast iron legs

Pedestal for ample log storage with sliding/tuck-away door.

Pedestal w/large and easily accessible ash pan.

Pedestal.

Outside air kits.

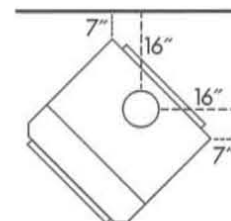
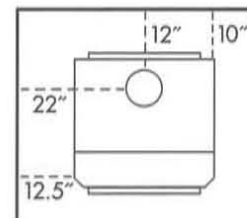

Approved Installation: Alcove, Mobile Homes (U.S. only) & Conventional

Mahogany W3100

Parts No.	Description
A-E-3100BLOWKIT	Blower Kit—All Units—Optional
A-BRICK-W31	Brick Panel Set
C-S-852	Damper Knob
C-G-050	(88066) Door Gasket
C-D-038	(891979) Door Glass
CW-D-031	Door Handle Shaft
CW-M-250	Door Handle Wood
C-S-110	Glass Clip
C-G-033	Glass Gasket (10 ft. package)
A-W3100-OAK	Outside Air Kit, Pedestal—Through Wall—Optional
CW-D-021	Latch Cam
A-W3100LEG-AIR	Outside Air Kit, Leg—Through Floor—Optional
A-W3100LEG-WALL	Outside Air Kit, Leg—Through Wall—Optional
CW-S-009	Secondary Air Tube—Front (First two tubes)
CW-S-009-R	Secondary Air Tube—Rear
CW-F-031	Woodruff Key

Maverick P22 FS



Specifications

Weight: 190 lbs.

Burn Time: Up to 45 hours

Max BTU: 40,000

Sq. Ft. Range: 400-1500

EPA: Exempt-Washington state approved

Dimensions

Width: 21.5 inch

Depth: 24.5 inch w/ash lip

Height: 28.5 inch

Hopper Capacity: Up to 45 lbs.

Up to 40,000 BTUs: Providing comforting heat from 400 sq. ft. to up to 1500 sq. ft. Remote and wall Thermostat compatible. 4 heat settings.

The Automatic Fuel Feed lets you burn up to 45 hours on each load with the 45 lb. hopper fuel capacity.

Heavy steel construction provides long-term reliability and durability.

One touch digital technology control board with multiple safety checks and diagnostics; extending the life and efficiency of your stove.

The "Hot Rod" Automatic Fire Starter igniter assures the stove lights quickly and safely. No messy starter gels needed.

Stainless steel burn pot. Removable for easy cleaning.

Special air wash system helps keep glass clean.

Limited 5 year warranty. 1 year electrical.

Options

Remote Control Thermostat: Radio Controlled with range up to 100 ft.

Door: Gold plated or brushed nickel

Cowl: Anodized gold or nickel.

Realistic ceramic fiber logs and brick panels.

Drop-in ash pan.

Freestanding Only

Legs: Gold plated, brushed nickel

Pedestal.

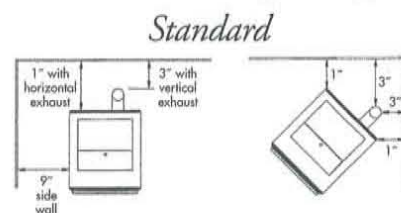
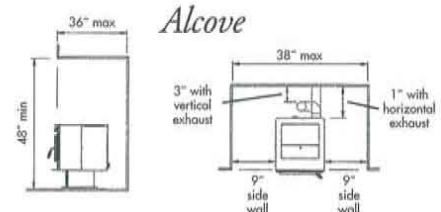

Approved Installation: Alcove, Mobile Homes & Conventional

Maverick P22 FS

Parts No.	Description
C-E-201	Air Switch
C-M-340-T	(891121) Air Switch Tube (Per Foot)
C-S-1060	Ash Cleanout Door
A-S-3018	Auger Biscuit, Octagon – Includes A-BUSHTOP & C-F-088
A-BUSHTOP	Auger Bushing – Top & Bottom, Brass (No Threads)
C-S-1078	Auger Cover Plate
C-E-017	Auger Motor
A-AUGPIN	(83529) Auger Pin
A-AUG-22	Auger Shaft
C-S-3030	Auger Stop Bracket
A-S-BURNPOT	Burnpot Assembly – Includes A-S-INSERT
A-S-INSERT	Burnpot Insert – Stainless Steel
A-TOOL-96	Cleaning Tool
A-E-027	Combustion Blower
A-E-033A	Convection Blower, with Gasket

Parts No.	Description
C-E-046-N	Fuse – 125V 5 AMP
C-G-105	Gasket, Combustion Blower – Housing to Motor
C-G-101	Gasket, Combustion Blower – Housing to Stove
C-G-100	Gasket, Convection Blower
C-G-050	(88066) Gasket, Door – 5/8" Firm Black
C-G-033	Gasket, Glass – 3/16" x 3/8" (10 ft. Package)
C-F-370	Grommet, Rubber – Damper
C-E-IGN	Igniter Element
C-E-060	Power Cord
C-E-071	Receptacle for Power Cord
AG-RCN	Remote Thermostat – Accumen
C-F-088	Retaining Ring – 5/8" – For A-BUSHTOP
C-E-090-21	Thermodisc, High Limit
C-E-090-22C	Thermodisc, Proof of Fire/Low Limit
C-E-UH1000	Wiring Harness, Universal for Digital Control Panel

Parts No.	Description
C-S-4170	Baffle, Top Plate
A-M-BRICK22	Brick Panels – P22, P4000
A-M-LOG	Ceramic Log
C-S-4084	Cam Latch – P22, P1000PB, P4000
C-S-999	Combustion Blower Transition – Aluminum
A-E-101	Control Panel, Digital
C-L-101	Control Panel Faceplate for A-E-101
A-DOORP22-BN	Door - P22, P1000PW - Brushed Nickel
A-DOORP22-P	Door – P22, P1000PW – Painted
A-DOORP22-G	Door - P22, P1000PW -Gold
C-D-050N	Door Handle, Spring – Chrome
C-D-050	(812002) Door Handle, Spring – Gold
A-H-KIT22	Handle Replacement Kit - P22
C-R-070-9	Heat Exchange Tube Cleaning Rod - P22
A-HINGEBASIC	Hinge, Door - P22, P1000PB, P1000PW
A-P22-EXT	Hopper Extension - P22
A-CL-22	Leg Kit - Painted - P22
A-PANEL-22	Panel, Complete Set - P22F
C-S-4020	Panel, Left Side - P22
C-S-277	Panel, Rear - P22
C-S-4045	Panel, Right Side - P22
A-P22-TRIMBN-LG	Trim Kit, Brushed Nickel - P22I Large Flashing
A-P22-TRIMBN-M	Trim Kit, Brushed Nickel - P22I Medium Flashing
A-P22-TRIM-LG	Trim Kit, Gold - P22I Large Flashing
A-P22-TRIM-M	Trim Kit, Gold - P22I Medium Flashing

Mojave P2700 FS



Up to 45,000 BTUs: Providing comforting heat from 400 sq. ft. to up to 2200 sq. ft. Remote and wall Thermostat compatible. 5 heat settings.

The Automatic Feed lets you burn up to 50 hours on each load with the 50 lb. hopper fuel capacity.

Heavy steel construction provides long-term reliability and durability.

One touch digital technology control board with multiple safety checks and diagnostics; extending the life and efficiency of your stove.

The "Hot Rod" Automatic Fire Starter igniter assures the stove lights quickly and safely. No messy starter gels needed.

Stainless steel burn pot. Removable for easy cleaning.

Large and easily accessible ash drawer.

Special air wash system helps keep glass clean.

Easy access rear, and swing-open side panels for quick maintenance and service.

Environmentally friendly: meeting or exceeding all federal and state emissions standards.

Limited 5 year warranty. 1 year electrical.

Options

Remote Control Thermostat: Radio Controlled with range up to 100 ft.

Gold plated, gold trim or brushed nickel doors with matching accents.

Realistic ceramic fiber logs and brick panels.

Specifications

Weight: 200 lbs.

Burn Time: Up to 50 hours

Max BTU: 45,000

Sq. Ft. Range: 400-2200

EPA: Exempt-Washington state approved

Dimensions

Width: 24 inch

Depth: 22.25 inch

Height: 31 inch

Hopper Capacity: Up to 50 lbs.

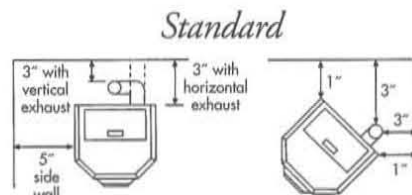
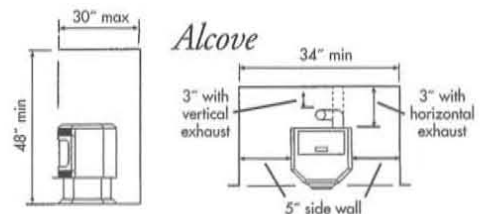

Approved Installation: Alcove, Mobile Homes & Conventional

Mojave P2700 FS

Parts No.	Description
C-E-201	Air Switch
C-M-340-T	(891121) Air Switch Tube (Per Foot)
C-S-1060	Ash Cleanout Door
A-S-3018	Auger Biscuit, Octagon – Includes A-BUSHTOP & C-F-088
A-BUSHTOP	Auger Bushing – Top & Bottom, Brass (No Threads)
C-S-1078	Auger Cover Plate
C-E-017	Auger Motor
A-AUGPIN	(83529) Auger Pin
A-AUG-22	Auger Shaft
C-S-3030	Auger Stop Bracket
A-S-BURNPOT	Burnpot Assembly – Includes A-S-INSERT
A-S-INSERT	Burnpot Insert – Stainless Steel
A-TOOL-96	Cleaning Tool
A-E-027	Combustion Blower
A-E-033A	Convection Blower, with Gasket

Parts No.	Description
C-E-046-N	Fuse – 125V 5 AMP
C-G-105	Gasket, Combustion Blower – Housing to Motor
C-G-101	Gasket, Combustion Blower – Housing to Stove
C-G-100	Gasket, Convection Blower
C-G-050	(88066) Gasket, Door – 5/8" Firm Black
C-G-033	Gasket, Glass – 3/16" x 3/8" (10 ft. Package)
C-F-370	Grommet, Rubber – Damper
C-E-IGN	Igniter Element
C-E-060	Power Cord
C-E-071	Receptacle for Power Cord
AG-RCN	Remote Thermostat – Accumen
C-F-088	Retaining Ring – 5/8" – For A-BUSHTOP
C-E-090-21	Thermodisc, High Limit
C-E-090-22C	Thermodisc, Proof of Fire/Low Limit
C-E-UH1000	Wiring Harness, Universal for Digital Control Panel

Parts No.	Description
A-S-ASHPANP2700	Ash Pan – P2700
A-M-BRICK27	Brick Panels – P2700
A-M-LOG	Ceramic Log
A-S-INSERTP2K	Burnpot Insert – Replacement for A-S-BURNPOT28F5 and A-S-BURNPOTP2K
C-S-810	Cam Latch – P2000, P2700
C-S-999	Combustion Blower Transition – Aluminum
A-E-401	Control Panel, Digital
C-L-401	Control Panel Faceplate for A-E-401
C-S-852	Damper Oak, Oak (Each)
C-S-851	Door Handle, Oak
A-D-1025BN	Door - P2700, Brushed Nickel
A-D-1025G	Door - P2700, Gold - Complete
A-D-1025P	Door - P2700, Painted - Complete
A-H-2000-KIT	Door Handle, Complete Replacement Kit
C-D-2700-A	Glass, Center
C-D-802-B	Glass, Side
C-S-1000	Glass, Connectors (Specify Model When Ordering)
C-M-066	(891148) Handle – Pocket Pull For Hopper Lid
C-R-070-16	Heat Exchange Tube Cleaning Rod - P2700
C-F-8154	Hinge - Female Left
C-F-8160	Hinge - Female Right
C-F-8150	Hinge - Male Left
C-F-8162	Hinge - Male Right
A-HINGEWELDMENT	Hinge Bracket, Door - P2000, P2700
C-S-1023-L	Panel, Left Side - P2700
C-S-1022	Panel, Rear - P2700
C-S-1023-R	Panel, Right Side - P2700

Solstice P7000



Up to 45,000 BTUs: Providing comforting heat from 400 sq. ft. to up to 2200 sq. ft. Remote and wall Thermostat compatible. 5 heat settings.

The Automatic Fuel Feed lets you burn up to 80 hours on each load with the huge 80 lb. hopper fuel capacity.

Heavy steel construction provides long-term reliability and durability.

Tri-source (front and sides) heat distribution system for maximum breadth of coverage.

One touch digital technology control board with multiple safety checks and diagnostics; extending the life and efficiency of your stove.

The control board is easily accessible.

The "Hot Rod" Automatic Fire Starter igniter assures the stove lights quickly and safely. No messy starter gels needed.

Stainless steel burn pot. Removable for easy cleaning.

Large and easily accessible ash drawer.

Special air wash system helps keep glass clean.

Limited 5 year warranty. 1 year electrical.

Options

Remote Control Thermostat: Radio Controlled with range up to 100 ft.

Specifications

Weight: 277 lbs.

Burn Time: Up to 80 hours

Max BTU: 45,000

Sq. Ft. Range: 400-2200

EPA: Exempt

Dimensions

Width: 22.25 inch

Depth: 26 inch

Height: 43.125 inch

Hopper Capacity: Up to 80 lbs.

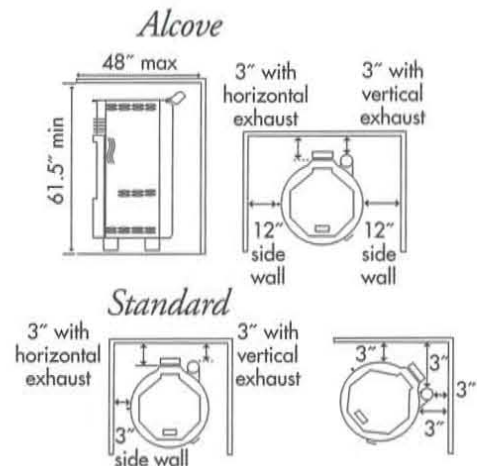

Approved Installation: Alcove, Mobile Homes & Conventional

Solstice P7000

Parts No.	Description
C-E-201	Air Switch
C-M-340-T	(891121) Air Switch Tube (Per Foot)
C-S-1060	Ash Cleanout Door
A-S-3018	Auger Biscuit, Octagon – Includes A-BUSHTOP & C-F-088
A-BUSHTOP	Auger Bushing – Top & Bottom, Brass (No Threads)
C-S-1078	Auger Cover Plate
C-E-017	Auger Motor
A-AUGPIN	(83529) Auger Pin
A-AUG-22	Auger Shaft
C-S-3030	Auger Stop Bracket
A-S-BURNPOT	Burnpot Assembly – Includes A-S-INSERT
A-S-INSERT	Burnpot Insert – Stainless Steel
A-TOOL-96	Cleaning Tool
A-E-027	Combustion Blower

Parts No.	Description
C-E-046-N	Fuse – 125V 5 AMP
C-G-105	Gasket, Combustion Blower – Housing to Motor
C-G-101	Gasket, Combustion Blower – Housing to Stove
C-G-100	Gasket, Convection Blower
C-G-050	(88066) Gasket, Door – 5/8" Firm Black
C-G-033	Gasket, Glass – 3/16" x 3/8" (10 ft. Package)
C-F-370	Grommet, Rubber – Damper
C-E-IGN	Igniter Element
C-E-060	Power Cord
C-E-071	Receptacle for Power Cord
AG-RCN	Remote Thermostat – Accumen
C-F-088	Retaining Ring – 5/8" – For A-BUSHTOP
C-E-090-21	Thermodisc, High Limit
C-E-090-22C	Thermodisc, Proof of Fire/Low Limit
C-E-UH1000	Wiring Harness, Universal for Digital Control Panel

Parts No.	Description
C-S-999	Combustion Blower Transition – Aluminum
A-E-401HORIZ	Control Panel, Digital
C-L-401HORIZ	Control Panel Faceplate for A-E-401HORIZ
A-E-035	Convection Blower
C-M-013	(891987) Damper Knob, Plastic
C-M-066	(891148) Handle – Pocket Pull For Hopper Lid
C-E-900	Hopper Switch - Solstice

Sonora P23 FS



Up to 42,000 BTUs: Providing comforting heat from 400 sq. ft. to up to 2000 sq. ft. Remote and wall Thermostat compatible. 5 heat settings.

The Automatic Fuel Feed lets you burn up to 55 hours on each load with the 55 lb. hopper fuel capacity.

Heavy steel construction provides long-term reliability and durability.

One touch digital technology control board with multiple safety checks and diagnostics; extending the life and efficiency of your stove.

The "Hot Rod" Automatic Fire Starter igniter assures the stove lights quickly and safely. No messy starter gels needed.

Stainless steel burn pot. Removable for easy cleaning.

Large and easily accessible ash drawer with pedestal; or discreet ash pan with leg model.

Special air wash system helps keep glass clean.

Easy access rear, and swing-open side panels for quick maintenance and service.

Environmentally friendly: meeting or exceeding all federal and state emissions standards.

Limited 5 year warranty. 1 year electrical.

Options

Remote Control Thermostat: Radio Controlled with range up to 100 ft.

Door: Gold plated, gold trim, or brushed nickel.

Legs: gold plated or brushed nickel

Realistic ceramic fiber logs and brick panels.

Specifications

Weight: 185 lbs.

Burn Time: Up to 55 hours

Max BTU: 42,000

Sq. Ft. Range: 400-2000

EPA: Exempt-Washington state approved

Dimensions

Width: 22.5 inch

Depth: 27 inch w/ash lip

Height: 29.25 inch FSA
28.5 inch FSL

Hopper Capacity: Up to 55 lbs.

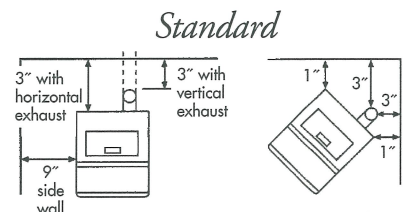
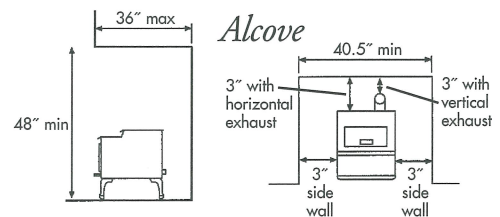

Approved Installation: Alcove, Mobile Homes & Conventional

Sonora P23 FS

Parts No.	Description
C-E-201	Air Switch
C-M-340-T	(891121) Air Switch Tube (Per Foot)
C-S-1060	Ash Cleanout Door
A-S-3018	Auger Biscuit, Octagon – Includes A-BUSHTOP & C-F-088
A-BUSHTOP	Auger Bushing – Top & Bottom, Brass (No Threads)
C-S-1078	Auger Cover Plate
C-E-017	Auger Motor
A-AUGPIN	(83529) Auger Pin
A-AUG-22	Auger Shaft
C-S-3030	Auger Stop Bracket
A-S-BURNPOT	Burnpot Assembly – Includes A-S-INSERT
A-S-INSERT	Burnpot Insert – Stainless Steel
A-TOOL-96	Cleaning Tool
A-E-027	Combustion Blower
A-E-033A	Convection Blower, with Gasket

Parts No.	Description
A-CL-ASH	Ash Pan – P23F on Legs
A-ASHPANP23PED	Ash Pan – P23F on Pedestal
A-M-BRICK23	Brick Panels – P23
A-M-LOG	Ceramic Log
C-S-4080	Cam Latch – P23, P1000PWA, P24
C-S-999	Combustion Blower Transition – Aluminum
A-E-401	Control Panel, Digital
C-L-401	Control Panel Faceplate for A-E-401
A-D-018-BN	Door - P23, Brushed Nickel
A-D-018-G	Door - P23, Gold
A-D-018-C	Door - P23, P1000PWA, Painted
A-D-018-PT	Door - P23, Painted w/Trim
C-D-050N	Door Handle, Spring – Chrome
C-D-050	(892002) Door Handle, Spring – Gold
C-F-091	Door Hinge Pin
C-D-038	(891979) Glass, Half Oval – P23, P1000PWA
C-M-066	(891148) Handle – Pocket Pull For Hopper Lid

Parts No.	Description
C-E-046-N	Fuse – 125V 5 AMP
C-G-105	Gasket, Combustion Blower – Housing to Motor
C-G-101	Gasket, Combustion Blower – Housing to Stove
C-G-100	Gasket, Convection Blower
C-G-050	(88066) Gasket, Door – 5/8" Firm Black
C-G-033	Gasket, Glass – 3/16" x 3/8" (10 ft. Package)
C-F-370	Grommet, Rubber – Damper
C-E-IGN	Igniter Element
C-E-060	Power Cord
C-E-071	Receptacle for Power Cord
AG-RCN	Remote Thermostat – Accumen
C-F-088	Retaining Ring – 5/8" – For A-BUSHTOP
C-E-090-21	Thermodisc, High Limit
C-E-090-22C	Thermodisc, Proof of Fire/Low Limit
C-E-UH1000	Wiring Harness, Universal for Digital Control Panel

Parts No.	Description
A-H-KIT23	Handle Replacement Kit - P23, P24, P1000PWA/PWC
C-R-070-14	Heat Exchange Tube Cleaning Rod - P23F
C-R-070-8	Heat Exchange Tube Cleaning Rod - P23I
C-F-8154	Hinge - Female Left
C-F-8160	Hinge - Female Right
C-F-8150	Hinge - Male Left
C-F-8162	Hinge - Male Right
C-F-291	Hinge Block
A-CLG-NEW	Leg Kit with Ashpan- Gold - P23F
C-S-288-L	Panel, Left Side - P23F
C-S-278	Panel, Rear - P23F
C-S-288-R	Panel, Right Side - P23F
A-P23-PNEW	Pedestal with Ashpan - P23
C-S-031-OPCBN	Trim, P23 Door - Brushed Nickel
C-S-031-OPC	Trim, P23 Door - Gold
C-S-031-OPCN	Trim, P23 Door - Polished Nickel

Please consult with Appendix for details on Boards, Burnpots, Augers, Auger Motors, due to changes by Serial Number.

Tahoe P2000 FS



Up to 45,000 BTUs: Providing comforting heat from 400 sq. ft. to up to 2200 sq. ft. Remote and wall thermostat compatible. 5 heat settings.

The Automatic Fuel Feed lets you burn up to 70 hours on each load with the 70 lb. hopper fuel capacity.

Heavy steel construction provides long-term reliability and durability.

One touch digital technology control board with multiple safety checks and diagnostics; extending the life and efficiency of your stove.

The "Hot Rod" Automatic Fire Starter igniter assures the stove lights quickly and safely. No messy starter gels needed.

Stainless steel burn pot. Removable for easy cleaning.

Large and easily accessible ash drawer.

Special air wash system helps keep glass clean.

Easy access rear, and swing-open side panels for quick maintenance and service.

Environmentally friendly: meeting or exceeding all federal and state emissions standards.

Limited 5 year warranty. 1 year electrical.

Options

Remote Control Thermostat: Radio Controlled with range up to 100 ft.

Gold plated, gold trim or brushed nickel doors with matching accents.

Realistic ceramic fiber logs and brick panels.

Specifications

Weight: 250 lbs.

Burn Time: Up to 70 hours

Max BTU: 45,000

Sq. Ft. Range: 400-2200

EPA: Exempt-Washington state approved

Dimensions

Width: 29.125 inch

Depth: 24.75 inch w/ash lip

Height: 30.5 inch

Hopper Capacity: Up to 70 lbs.

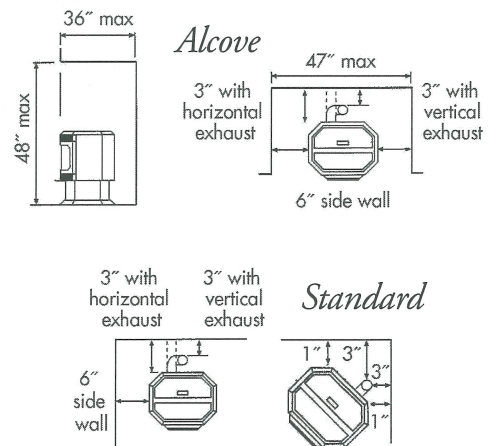

Approved Installation: Alcove, Mobile Homes & Conventional

Tahoe P2000 FS

Parts No.	Description
C-E-201	Air Switch
C-M-340-T	(891121) Air Switch Tube (Per Foot)
C-S-1060	Ash Cleanout Door
A-S-3018	Auger Biscuit, Octagon – Includes A-BUSHTOP & C-F-088
A-BUSHTOP	Auger Bushing – Top & Bottom, Brass (No Threads)
C-S-1078	Auger Cover Plate
C-E-017	Auger Motor
A-AUGPIN	(83529) Auger Pin
A-AUG-22	Auger Shaft
C-S-3030	Auger Stop Bracket
A-S-BURNPOT	Burnpot Assembly – Includes A-S-INSERT
A-S-INSERT	Burnpot Insert – Stainless Steel
A-TOOL-96	Cleaning Tool
A-E-027	Combustion Blower
A-E-033A	Convection Blower, with Gasket

Parts No.	Description
C-E-046-N	Fuse – 125V 5 AMP
C-G-105	Gasket, Combustion Blower – Housing to Motor
C-G-101	Gasket, Combustion Blower – Housing to Stove
C-G-100	Gasket, Convection Blower
C-G-050	(88066) Gasket, Door – 5/8" Firm Black
C-G-033	Gasket, Glass – 3/16" x 3/8" (10 ft. Package)
C-F-370	Grommet, Rubber – Damper
C-E-IGN	Igniter Element
C-E-060	Power Cord
C-E-071	Receptacle for Power Cord
AG-RCN	Remote Thermostat – Accumen
C-F-088	Retaining Ring – 5/8" – For A-BUSHTOP
C-E-090-21	Thermodisc, High Limit
C-E-090-22C	Thermodisc, Proof of Fire/Low Limit
C-E-UH1000	Wiring Harness, Universal for Digital Control Panel

Parts No.	Description
A-P2K-ASHPAN	Ash Pan – P2000F
A-P2KI-ASHDROP	Ash Pan, Drop In – P2000I
C-S-4170	Baffle, Top Plate
A-M-BRICK2000	Brick Panels – P2000
A-M-2000	Ceramic Log
A-S-INSERTP2K	Burnpot Insert – Replacement for A-S-BURNPOT28FS and A-S-BURNPOTP2K
C-S-810	Cam Latch – P2000, P2700
C-S-999	Combustion Blower Transition – Aluminum (FS Only)
A-E-401	Control Panel, Digital
C-L-401	Control Panel Faceplate for A-E-401
C-S-852	Damper Oak, Oak (Each)
C-S-851	Door Handle, Oak
A-D-807BN	Door - P2000, Brushed Nickel
A-D-807G	Door - P2000, Gold
A-D-807PT	Door - P2000, Painted w/Trim
A-H-2000-KIT	Door Handle, Complete Replacement Kit

Parts No.	Description
C-D-802-A	Glass, Center
C-D-802-B	Glass, Side
C-S-1000	Glass, Connectors (Specify Model When Ordering)
C-M-066	(891148) Handle – Pocket Pull For Hopper Lid
C-S-836	Heat Exchange Tube Cleaning Rod - P2000F
C-R-070-17	Heat Exchange Tube Cleaning Rod - P2000I
C-F-8154	Hinge - Female Left
C-F-8160	Hinge - Female Right
C-F-8150	Hinge - Male Left
C-F-8162	Hinge - Male Right
A-HINGEWELDMENT	Hinge Bracket, Door - P2000, P2700
C-S-834-L	Panel, Left Side - P2000F
C-S-835	Panel, Rear - P2000F
C-S-834-R	Panel, Right Side - P2000F
A-MED-A	Trim Kit, Gold - P2000I Medium Flashing
C-S-862	Trim, P2000 Door

Please consult with Appendix for details on Boards, Burnpots, Augers, Auger Motors, due to changes by Serial Number.

Window Pellet Unit SP8000

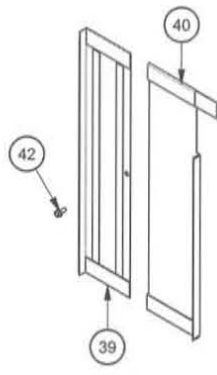
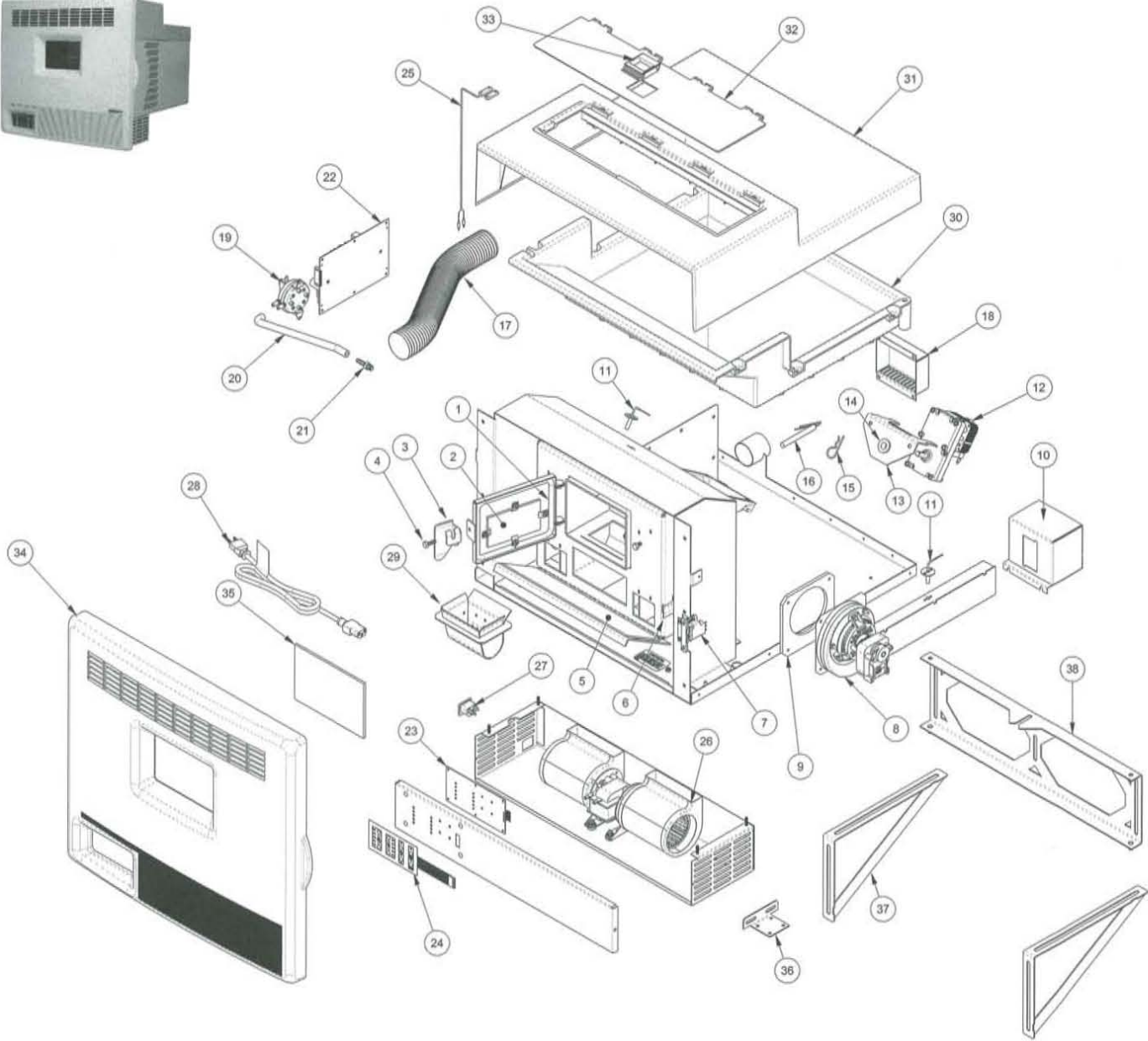

LEFT SIDE

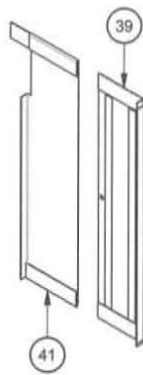

RIGHT SIDE

FILLER PANELS



FOAM INSULATOR
 PANEL
 CUT-TO-SIZE

Window Pellet Unit SP8000

Key	Parts No.	Description	Qty.
1	88033	3/8" Rope Gasket	3 FT
2	891544	Glass, Combustion Chamber	1
3	891951	Latch, Door	1
4	83339	1/4-20 Bolt	1
N/S	83261	1/4-20 Lock Nut	1
5	88144	Gasket, Cleanout	1
6	891952	Draw Latch	2
7	891542	Latch, Push-to-Close/Microswitch	1
8	80573	Blower, Exhaust - 70CFM	1
9	88129	Gasket, Exhaust Blower	1
10	891702	Suppressor, Spark	1
11	80531	Resistance Temp. Detector (RTD)	2
12	80529	Motor, Auger	1
13	891747	Assy., Auger Bushing (Includes item 14)	1
14	891132	Agitator Bushing	1
N/S	83534	Bushing Retainer Ring	1
15	83529	Hairpin	1
16	80543	Ignitor Cartridge	1
17	86615	2" ID x 18" Flex MTL Hose	1
18	891589	Cover, Intake	1
19	80549	Switch, Pressure	1
20	891121	Hose, Silicone	1 FT
21	89586	Nipple, Auger	1
22	80545	Controller Board Assy.	1

Key	Parts No.	Description	Qty.
23	80555	PWA, Display Board	1
24	80550	Keypad, Assembly	1
N/S	80544	Wiring Harness, Main	1
N/S	80559	Wiring Harness, Switches	1
N/S	80551	Wiring Harness, Display Interface	1
25	80546	Proximity Switch	1
26	80542	Room Blower 125CFM	1
27	80462	Receptacle, 3 Prong	1
28	80557	Power Supply Cord	1
29	891588	Burn Pot	1
30	891534	Hopper	1
31	891532	Top, Cabinet	1
32	891533	Lid, Fuel	1
33	891541	Slide Latch	1
34	891535	Front	1
35	891545	Glass, Front Viewing	1
36	891742	Support Bracket (Window Sill)	2
37	891956	Weldment, Knee/Support Brace	2
38	891955	Retention Bracket	1
39	891959	Filler Panel, Slide	2
40	891958	Filler Panel, Left	1
41	891957	Filler Panel, Right	1
42	83343	#10 x 1/2" Self-Drilling Screw	2
43	891960	Foam, Corrugated 7/8"	1

Up to 24,000 BTUs: Providing comforting heat up to 750 sq. ft.

The Automatic Fuel Feed lets you burn up to 33 hours on each load with the 33 lb. hopper fuel capacity.

Stove comes with everything included for a quick, easy and safe installation.

New patented design

Electronic controls.

Quiet 125CFM blower.

Standard 3-prong 110 volt power supply.

The Automatic Fire Starter igniter assures the stove lights quickly and safely. No messy starter gels needed.

Remote Control

One touch digital technology control board with multiple safety checks and diagnostics; extending the life and efficiency of your stove.

Environmentally friendly: meeting or exceeding all federal and state emissions standards.

Easily installs into an existing window or through the wall.

Specifications

Weight: 127 lbs.

Burn Time: Up to 30 hours

Max BTU: 24,000

Sq. Ft. Range: 750

Hopper Capacity: Up to 30 lbs.

Dimensions

Width: 22.5 inch (at rear)

Width Opening: 22.875 inch

Depth: 24.875 inch

Height: 21.375 inch

EPA: Certified Washington state approved

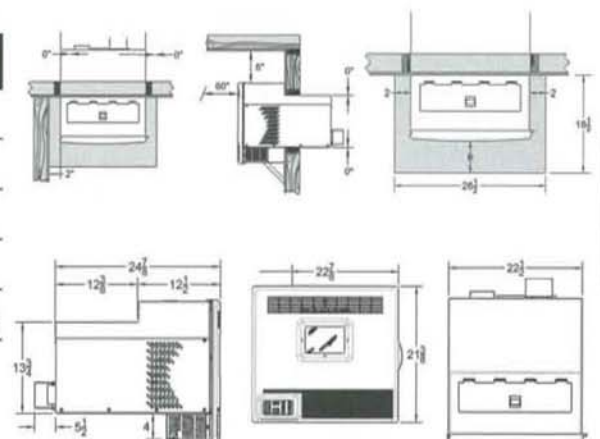

Universal Parts



Part: 89066 Firebrick -

Brand

Model

Englander AC-SB

All wood stoves, 18TR, 18TRD, 50SHW10

Vogelzang 25-08

Norseman 2500



Part: 80230 Distribution Blower -

Brand

Model

Vogelzang 25-41

Norseman 2500



Part: 40257 Shaker Grate -

Brand

Model

Vogelzang 25-40

Norseman 2500



Part: 40256 Grate Frame -

Brand

Model

Vogelzang 25-39

Norseman 2500



Part: 80145 Honeywell Limit Control -

Adjustable temperature settings



Part: 80488 1 RPM motor, revolves clockwise -

Brand	Model
Danson KS5010-1010	FGB, IGB, Bayview freestanding, Bayview insert
Napoleon W435-0009	NPS45
Quadrafire 812-0170	800, 1000



Part: 80456 4 RPM motor, revolves counterclockwise -

Brand	Model
Danson KS5010-1010	FGB, IGB, Bayview freestanding, Bayview insert
Napoleon W435-0009	NPS45
Quadrafire 812-0170	800, 1000



Part: DGK2 Door Gasket Kit -

3/8 in. rope gasket, 6.7 feet long
 Silicone



Part: DGK3 Door Gasket Kit -

1/2 in. rope gasket, 6.8 feet long
 Silicone

Breckwell Hearth Products Serial Number Chart

Year	P20	P22	P23FS	P23I	P24FS	P24I	P26
1989			P		500001	10001	
1990					600001	20001	
1991	1001				70001	30001	
1992	2001				85000- ORV 600,000	40000- ORV 200,000	
1993					85000- ORV 700,000	45000- ORV 300,000	90001
1994					94-86289	94-45351	94-90538
1995	491				94-87807/ IGNITOR	94-87807/ IGNITOR	91711
1996			3000	1000	50798/5800	FSA-50751/FSL-90000	
1997							
1998							
1999							
2000			5467	1522	52509		
2001			5988	1663	52758		
2002		3401	7062	2195	53838		
2003		4382	7721	2507	54115		
2004		5479	8739	2736	54523		
2005		6676	9464	3121	54921		
2006		8308	10349	3636	55461		
2007		10196	12849	4686	56450		

Year	P28	P32I	P1000	P2000FS	P2000I	P2700	P4000
1989							
1990							
1991							
1992		50001					
1993		55000					
1994		94-57164					
1995		94-57839					
1996	?	58000					
1997							
1998							
1999							
2000				10784	20561	7382	
2001				11133	21061	7755	
2002				11756	22152	8384	
2003				12030	22480	8640	
2004			100	12427	22982	8952	
2005			2180	12885	23632	9332	100
2006			6624	13326	24393	10222	1001
2007			16930	13959	25706	11802	2483

Breckwell Hearth Products Analog / Digital Circuit Board charts

Part #	Board				Settings	Upgrade Board	Notes:
	Type	RPM	Model	When Used			
A-E-CB91	Analog	4	P24	1990-1991	1,2,3,4, Max	A-E-301	1
A-E-CB91	Analog	4	P24I	1990-1991	1,2,3,4, Max	A-E-301	1
A-E-CB91	Analog	4	P20	1990	High, Medium, Low	A-E-301	1
A-E-022	Analog	1	P22	Old P22	High, Medium, Low	A-E-101	1
A-E-022	Analog	1	P23	Prior to 1999	Low, B,C, High	A-E-101	1
A-E-057	Analog	1	P22	Old P22	Low, B,C, High	A-E-101	1
A-E-057	Analog	1	P23	Prior to 1999	Low,B,C,D,E,Max	A-E-101	1
C-E-950	Analog	4	P20	1991	Low,B,C,D,E,Max	A-E-950KIT	2
C-E-950	Analog	4	P23	1999 models to S/N 6331	Low,B,C,D,E,Max	A-E-950KIT	2
C-E-950	Analog	4	P23I	1999 Models to S/N 1915	Low,B,C,D,E,Max	A-E-950KIT	2
C-E-950	Analog	4	P24	1992 models to S/N 90,000	Low,B,C,D,E,Max	A-E-950KIT	2
C-E-950	Analog	4	P24I	1992 models to S/N 53318	Low,B,C,D,E,Max	A-E-950KIT	2
C-E-950	Analog	4	P26	All units	Low,B,C,D,E,Max	A-E-950KIT	2
C-E-950	Analog	4	P28	All units	Low,B,C,D,E,Max	A-E-950KIT	2
C-E-950	Analog	4	P28I	All units	Low,B,C,D,E,Max	A-E-950KIT	2
C-E-950	Analog	4	P32I	All units	Low,B,C,D,E,Max	A-E-950KIT	2
C-E-950	Analog	4	P2000	All Analog Units	Low,B,C,D,E,Max	A-E-950KIT	2
C-E-950	Analog	4	P2000I	All Analog Units	Low,B,C,D,E,Max	A-E-950KIT	2
C-E-950	Analog	4	P2700	up to 7899	Low,B,C,D,E,Max	A-E-950KIT	2

Part #	Board				Settings	Upgrade Board	Notes:
	Type	RPM	Model	When Used			
A-E-301	Digital	4	P23	6332 - 7165	1,2,3,4,5		3
A-E-301	Digital	4	P23I	1916 - 2242	1,2,3,4,5		3
A-E-301	Digital	4	P24	53319 - 53663	1,2,3,4,5		3
A-E-301	Digital	4	P24I	53220 - 53794	1,2,3,4,5		3
A-E-301	Digital	4	P2000	-11779	1,2,3,4,5		3
A-E-301	Digital	4	P2000I	-22207	1,2,3,4,5		3
A-E-301	Digital	4	P2700	7900 - 8444	1,2,3,4,5		3
A-E-401	Digital	1	P23	7166 -	1,2,3,4,5		4
A-E-401	Digital	1	P23I	2243 -	1,2,3,4,5		4
A-E-401	Digital	1	P24	53664 -	1,2,3,4,5		4
A-E-401	Digital	1	P24I	53795 -	1,2,3,4,5		4
A-E-401	Digital	1	P2000	11780 -	1,2,3,4,5		4
A-E-401	Digital	1	P2000I	22208 -	1,2,3,4,5		4
A-E-401	Digital	1	P2700	8445 -	1,2,3,4,5		4
A-E-401	Digital	1	P1000	ALL UNITS	1,2,3,4,5		4
A-E-101	Digital	1	P22	224-	1,2,3,4		4
A-E-101	Digital	1	P4000	ALL UNITS	1,2,3,4		4

(1) = Need to also order the C-E-UH1000 wiring Harness. The hole for the board in the side panel will have to be enlarged to accommodate new board

(2) = The kit consists of a C-E-301 Board and a C-E-UH1000 wire harness

(3) = 4-RPM Boards use the C-E-010 Auger Motor

(4) = 1-RPM Boards use the C-E-017 Auger Motor

Note: If there is a knob for selecting the heat setting the Board is Analog

Breckwell Hearth Products Burn Pot and Auger Info

Stove Model	Year / SN	Burn Pot	Auger	RPM	Auger Motor	Auger Notes
P20			A-AUG-28	4	C-E-010	1
P22	PRE 1994	A-S-BURNPOTNI	A-AUG-22	1	C-E-017	
P22	1994~	A-S-BURNPOT	A-AUG-22	1	C-E-017	
P23	~ 1999	A-S-BURNPOT	A-AUG-22	1	C-E-017	
P23	2000 - 2001	A-S-BURNPOT	A-AUG	4	C-E-010	
P23FS	s/n: 7166 ~	A-S-BURNPOT	A-AUG-22	1	C-E-017	
P23I	s/n: 2243 ~	A-S-BURNPOT	A-AUG-22	1	C-E-017	
P24	PRE 1994	A-S-BURNPOTNI	A-AUG-28	4	C-E-010	1
P24	1994 - 1998	A-S-BURNPOT	A-AUG-28	4	C-E-010	1
P24	1999 - 2001	A-S-BURNPOT	A-AUGSHFT	4	C-E-010	
P24	s/n: 53656 - 53663	A-S-BURNPOT	A-AUG	4	C-E-010	
P24FS	s/n: 53664 ~	A-S-BURNPOT	A-AUG-22	1	C-E-017	
P24I	s/n: 53795 ~					
P26		A-S-BURNPOTNI	A-AUG-28	4	C-E-010	1
P28FS		A-S-BURNPOT28FS	A-AUG-28	4	C-E-010	
P28I		A-S-BURNPOTP2K	A-AUG-28	4	C-E-010	
P32	PRE 1994	A-S-BURNPOTNI	A-AUG-28	4	C-E-010	1
P32	1994 ~	A-S-BURNPOT	A-AUG-28	4	C-E-010	1
P2000FS	~ WH98-12029	A-S-BURNPOTP2K	A-AUG-28	4	C-E-010	
P2000FS	WH98-12030 ~	A-S-BURNPOT				
P2000FS	1999-2001		A-AUGSHFT	4	C-E-010	
P2000FS	s/n: 11780		A-AUG-22	1	C-E-017	
P2000I	~ WH98-22364	A-S-BURNPOTP2K				
P2000I	WH98-22365 ~	A-S-BURNPOT				
P2000I		A-S-BURNPOT				
P2000I	1998		A-AUG-28	4	C-E-010	
P2000I	1999-2001		A-AUGSHFT	4	C-E-010	
P2000I	s/n: 22208 ~		A-AUG-22	1	C-E-017	
P2700	s/n:~ 8200	A-S-BURNPOTP2K				
P2700	s/n: 8201 ~	A-S-BURNPOT				
P2700	1999		A-AUGSHFT	4	C-E-010	1
P2700	2000 - 2001		A-AUG	4	C-E-010	
P2700	s/n: 8445 ~		A-AUG-22	1	C-E-017	
P1000		A-S-BURNPOT	A-AUG-22	1	C-E-017	

1) Requires A-AUGCP-22 coupler if old shaft has solid end