



KING KING CANADA

03/2015

POWER FORCE

2000W GASOLINE DIGITAL INVERTER GENERATOR



Read this manual. Do not attempt to operate this generator until you have read and understood the safety, operation, and maintenance instructions

MODEL: KCG-2001i

INSTRUCTION MANUAL

COPYRIGHT © 2015 ALL RIGHTS RESERVED BY KING CANADA TOOLS INC.

WARRANTY & SERVICE INFORMATION



**1-YEAR
LIMITED WARRANTY
FOR THIS 2000W INVERTER GENERATOR**

**KING CANADA TOOLS
OFFERS A 1-YEAR LIMITED WARRANTY
FOR NON-COMMERCIAL USE.**



BEFORE CALLING THE ABOVE TOLL-FREE NUMBER, PLEASE READ THIS MANUAL, SPECIFICALLY THE SAFETY PRECAUTIONS, THE INSPECTION BEFORE OPERATION AND THE TROUBLESHOOTING GUIDE.

• DO NOT RETURN THE DEFECTIVE PRODUCT TO THE RETAILER.

WARRANTY INFORMATION

PROOF OF PURCHASE

Please keep your dated proof of purchase for warranty and servicing purposes.

REPLACEMENT PARTS

Replacement parts for this generator are available at our authorized KING CANADA generator service centers across Canada. For servicing, call the above toll free number to get servicing instructions and be sure to have your proof of purchase if you are claiming warranty work.

LIMITED TOOL WARRANTY

KING CANADA makes every effort to ensure that this product meets high quality and durability standards. KING CANADA warrants to the original retail consumer a 1-year limited warranty as of the date the product was purchased at retail and that each product is free from defects in materials.

THIS WARRANTY IS NOT TRANSFERABLE AND DOES NOT COVER

- Damage or liability caused by shipping, improper handling, improper installation, improper maintenance, improper modification, or the use of accessories and/or attachments not specifically recommended.
- Repairs necessary because of operator abuse or negligence, or the failure to install, operate, maintain, and store the product according to the instructions in the owner's manual.
- Damage caused by cold, heat, rain, excessive humidity, corrosive environments and materials, or other contaminants.
- Expendable items that become worn during normal use such as fuel filters, air cleaners, spark plugs, and engine oil.
- Cosmetic defects that do not interfere with product functionality.
- Freight costs from customer to an authorized warranty service location.
- Repair and transportation costs of products or parts determined not to be defective.
- ANY INCIDENTAL, INDIRECT OR CONSEQUENTIAL LOSS, DAMAGE, OR EXPENSE THAT MAY RESULT FROM ANY DEFECT, FAILURE OR MALFUNCTION OF THE PRODUCT.

• RETAIN THE ORIGINAL CASH REGISTER SALES RECEIPT AS PROOF OF PURCHASE FOR WARRANTY WORK.

KING CANADA shall in no event be liable for death, injuries to persons or property or for incidental, special or consequential damages arising from the use of our products. Shipping and handling charges may apply. If a defect is found, KING CANADA will either repair or replace the product.



BASIC & SPECIFIC SAFETY PRECAUTIONS

BE CAREFUL!

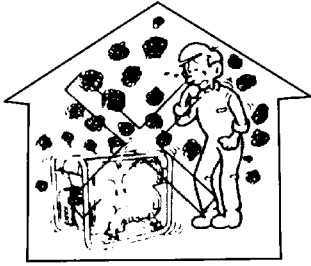

**DO NOT USE
IN YOUR HOUSE**



**DO NOT USE IN
WET CONDITIONS**

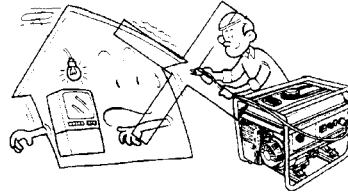

**DO NOT CONNECT TO
HOUSEHOLD CIRCUIT**

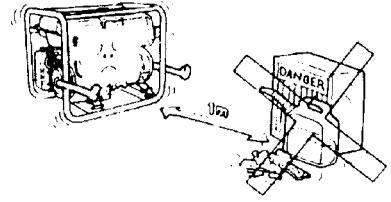

**KEEP FLAMMABLE
MATERIALS AWAY**

WHEN REFUELING;

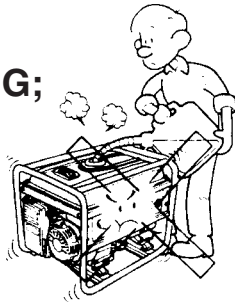

STOP ENGINE!

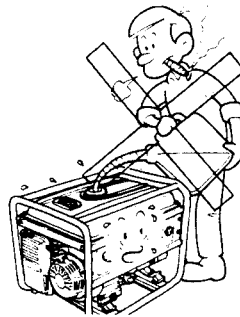

NO SMOKING!

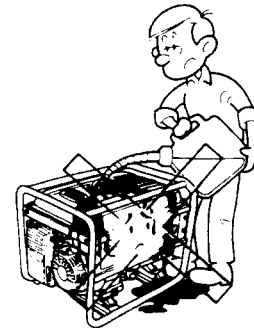

DO NOT SPILL GASOLINE!

BASIC SAFETY INFORMATION

EXHAUST FUMES ARE DANGEROUS

•Never operate the engine in a closed area or it may cause unconsciousness and death within a short time. Operate in a well ventilated area.

FUEL IS HIGHLY FLAMMABLE AND POISONOUS

- Always turn off the engine when refueling.
- Never refuel while smoking or in the vicinity of an open flame.
- When operating or transporting this generator, be sure to keep it upright. If it tilts, fuel may leak from the carburetor or fuel tank.

ENGINE AND MUFFLER MAY BE HOT

- Place the generator in an appropriate location, away from children and pedestrians.
- Avoid placing any flammable materials near the exhaust outlet during operation.
- Keep a 4ft. clearance from buildings or other equipment around the generator to prevent overheating.

ELECTRIC SHOCK PREVENTION

- Never operate in rain or snow.
- Never touch the generator with wet hands or electric shock will occur.
- Be sure to ground (earth) the generator.

ELECTRICAL CONNECTION NOTES

- Avoid connecting the generator to commercial power outlet.
- Avoid connecting the generator in parallel with any other generator.

WARNING! The engine muffler will be very hot after use, avoid touching the engine or muffler while they are still hot.

FUEL

Make sure there is sufficient fuel in the tank.

GROUNDING

Make sure to ground the generator.

SPECIFIC SAFETY INFORMATION

Attempting to connect generator directly to the electrical system of any building structure.

Back feeding electricity through a building's electrical system to the outside utility feed lines could endanger repair persons attempting to restore service.

Failure to use a double throw transfer switch when connecting to a structure's electrical system can damage appliances and **WILL VOID** the manufacturer's warranty.

Never backfeed electricity through a structure's electrical system. To connect to a structure's electrical system in a safe manner, always have a Double-Throw Transfer Switch installed by a qualified electrician and in compliance with local ordinances. (When installing a Double-Throw Transfer Switch, a minimum of 10 gauge wiring must be used).

SPECIFIC SAFETY PRECAUTIONS



OPERATION OF GENERATOR IN RAIN, WET, ICY, OR FLOODED CONDITIONS.

Water is an excellent conductor of electricity! Water which comes in contact with electrically charged components can transmit electricity to the frame and other surfaces, resulting in electrical shock to anyone contacting them.

Operate generator in a clean, dry, well ventilated area. Make sure hands are dry before touching unit.

TAMPERING WITH FACTORY SET ENGINE SPEED SETTINGS.

Engine speed has been factory set to provide safe operation. Tampering with the engine speed adjustment could result in overheating of attachments and could cause a fire.

Never attempt to "speed-up" the engine to obtain more performance. Both the output voltage and frequency will be thrown out of standard by this practice, endangering attachments and the user.

IMPROPER CONNECTION OF ITEMS TO GENERATOR.

Exceeding the load capacity of the generator by attaching too many items, or items with very high load ratings to it could result in overheating of some items or their attachment wiring resulting in fire or electrical shock. Make sure that the sum total of electrical loads for all attachments does not exceed the load rating of the generator.

ATTEMPTING TO FILL THE FUEL TANK WHILE THE ENGINE IS RUNNING.

Gasoline and gasoline vapors can become ignited by coming in contact with hot components such as the muffler, engine exhaust gases, or from an electrical spark.

Turn engine off and allow it to cool before adding fuel to the tank. Equip area of operation with a fire extinguisher certified to handle gasoline or fuel fires.

SPARKS, FIRE, HOT OBJECTS

Cigarettes, sparks, fires, or other hot objects can cause gasoline or gasoline vapors to ignite.

Add fuel to tank in well ventilated area. Make sure there are no sources of ignition near the generator.

INADEQUATE VENTILATION FOR GENERATOR

Materials placed under, against or near the generator or operating the generator in areas where the temperature exceeds 40° C ambient (such as storage rooms or garages) can interfere with its proper ventilation features causing overheating and possible ignition of the materials or buildings.

Operate generator in a clean, dry, well ventilated area a minimum of four feet from any building, object or wall. **DO NOT OPERATE UNIT IN-DOORS OR IN ANY CONFINED AREA.**

RISK OF BREATHING - INHALATION HAZARD

Operate generator in clean, dry, well ventilated area. Never operate unit in enclosed areas such as garages, basements, storage, sheds, or in any location occupied by humans or animals.

Keep children, pets and others away from area of operating unit. Breathing exhaust fumes will cause serious injury or death. **Gasoline engines produce toxic carbon monoxide exhaust fumes.**

USE OF WORN, DAMAGED, UNDERSIZED OR UNGROUNDED EXTENSION CORDS.

Contact with worn or damaged extension cords could result in electrocution. Use of undersize extension cords could result in overheating of the wires or attached items, resulting in fire.

Use of ungrounded extension cords could prevent operation of circuit breakers and result in electrical shock.

Inspect extension cords before use and replace with new cord if required. Use proper size (wire gauge) extension cords for application as shown below. Always use a extension cords having a grounding wire with an appropriate grounding plug. **DO NOT** use an ungrounded plug.

An extension cord that is hot to the touch is overloaded. Repair or replace damaged extension cords immediately.

Cord Length	Wire Gauge Size	Amps
0-100 FEET	NO.12	Up to 20 Amps.

AIR CLEANER FILTER

Never run the engine without the air cleaner filter installed properly.

LIMIT OPERATION

Limit operation requiring maximum power to 30 minutes maximum. For continuous operation, do not exceed the rated power of 1600W. Do not exceed the current limit specified for any one receptacle.

DO NOT MODIFY GENERATOR

Do not modify the generator for other purposes than its intended use. Do not connect generators together in parallel. Do not connect an extension to the exhaust/muffler pipe.

12V DC OPERATION

The DC receptacle can be used while the AC output is in use. If you use both at the same time, make sure not to exceed the rated power.

DISPOSAL

Please dispose of used motor oil in a manner that protects the environment. Do not throw it in the trash or pour it on the ground. Take the used motor oil to your local waste disposal service station.





GETTING TO KNOW YOUR DIGITAL INVERTER GENERATOR

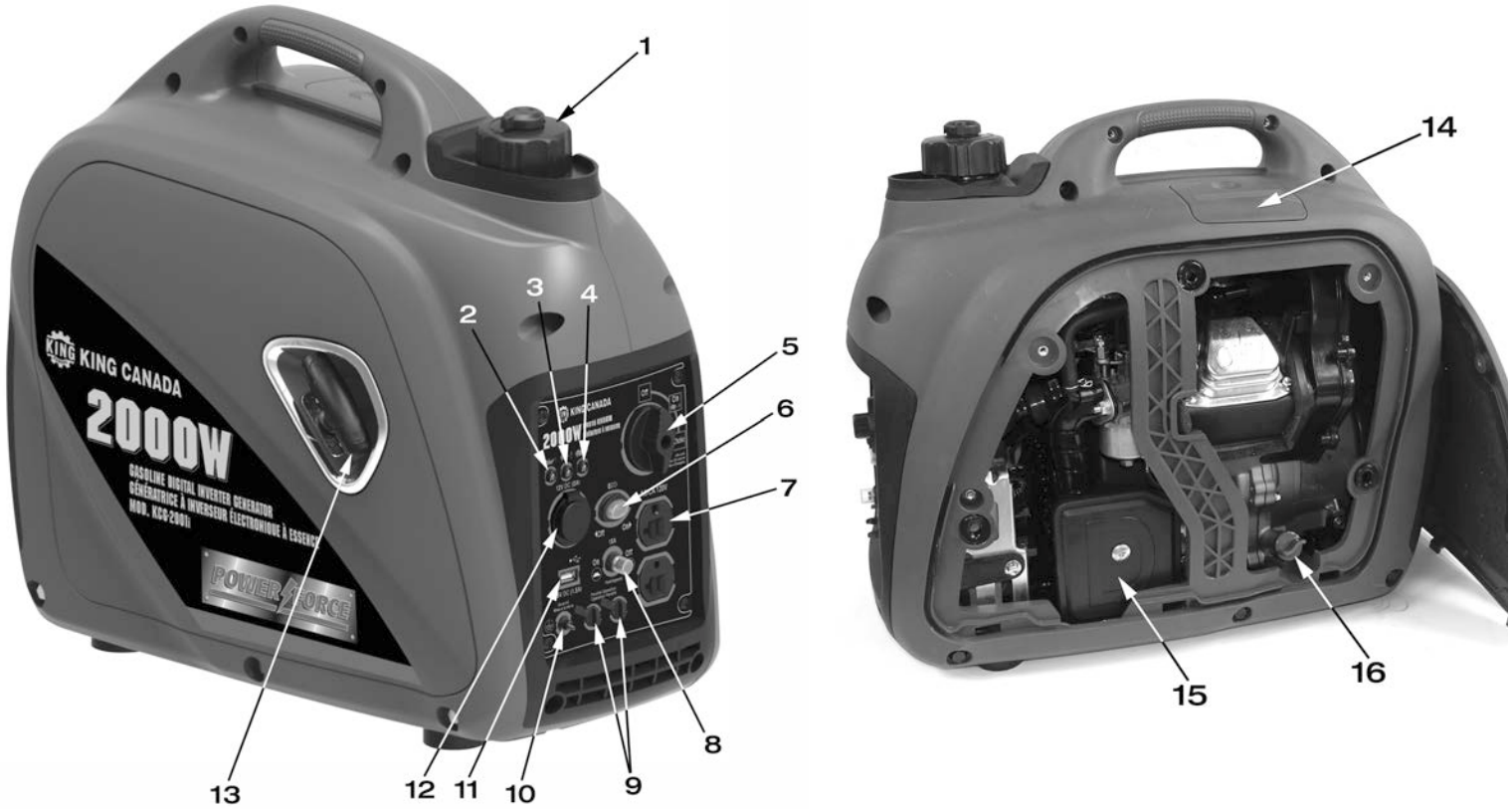

1. **Fuel cap.** Make sure the fuel cap is always screwed on tightly. Use unleaded gasoline only! 4.5 Liter capacity. Turn cap lever to the “On” position before use, and “Off” after use.
2. **Low oil warning indicator light.** Lights up when oil level is too low. This generator detects and shuts off automatically when the oil level is too low. In case of an auto shut-off and the indicator light is ON, check oil level with dipstick (#16) and fill to recommended level with SAE 10W30 engine oil.
3. **Overload indicator light.** Lights up when generator is overloaded.
4. **Power indicator light.** Lights up when generator is ready to use.
5. **On/Off/Choke dial.** Must be placed to the “Choke” position before pulling the recoil starter handle. Once the engine is started, it is necessary to gradually turn the dial to the “On” position, see instructions further in this manual.
6. **Economical mode switch.** Adjusts the engine speed based on connected load, for improved fuel consumption.
7. **Duplex AC 120V outlets.** Plug up to 2-120V appliances or a power bar, make sure the amps requirement does not exceed max amps

- (16 amps) or else the AC reset will automatically shut-off the power output.
8. **15 Amp AC Reset.** The AC reset turns generator off automatically when the load exceeds the generator maximum output. Reduce the load to within specified generator rated output if AC reset trips.
9. **Parallel connectivity ports.** Connect two inverter generators using optional Parallel Cable for combined output power.
10. **Grounding terminal.** This generator must be grounded, see grounding instructions.
11. **5V USB Port.** Use to power and charge USB powered devices.
12. **12V DC Socket.** Use to power 12V DC items.
13. **Recoil starter.** Pull quickly to start the engine.
14. **Spark plug access cover.** Periodically the spark plug must be checked and maintained, see maintenance section.
15. **Air cleaner filter/cover.** Periodically the air cleaner filter must be checked and maintained, see maintenance section.
16. **Oil gauge dipstick.** Check the oil level using this oil gauge dipstick.

MODEL	KCG-2001i
Peak Wattage (starting)	2000W
Running Wattage	1600W
AC Outputs	1 (2x 120V/13.3A)
DC Outputs	12V (8A)/ 5V (1.5A)
Engine (OHV)	3 HP
No load speed	4,800 RPM
Displacement (cc)	80
Fuel	Unleaded Gasoline
Fuel tank (L)	4.5
Oil capacity (L)	0.35
Run time	5-6 hours
Noise level	61 dB(A)
Dimensions (LxWxH)	19" x 10-1/2" x 18-1/2"
Weight	48 lbs

PRE-START CHECK



ASSEMBLY

Your Digital Inverter Generator comes completely assembled, please proceed to the pre-start check before attempting to start the engine.

PRE-START CHECK

WARNING! To prevent permanent damage to generator or any appliances, you **MUST** check oil level, fuel level, air cleaner filter and unplug any load from the generator before starting.

OIL LEVEL

WARNING! This generator has been shipped from the factory without oil or very little oil in the crankcase. Operating the unit without the correct amount of oil can damage the engine. Oil crankcase capacity: 0.35 litres. Always check the oil level before starting the generator, make sure the generator is on a level surface. To check oil level;

- 1) Remove the rear access cover.
- 2) Turn the oil gauge dipstick (A) Fig.1A counterclockwise, remove it and clean it with a clean cloth.
- 3) Fully reinsert the oil gauge dipstick and pull it out to check the oil level.
- 4) If the oil level is halfway up the dipstick or below, refill with SAE 10W30 oil through the dipstick hole (using the supplied oil fill container) until the oil level reaches 3/4 up the dipstick or until it reaches the bottom lip of the dipstick hole as shown in illustration Fig.1B.

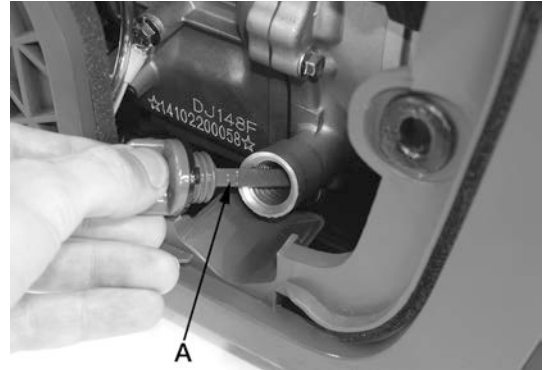

Figure 1A

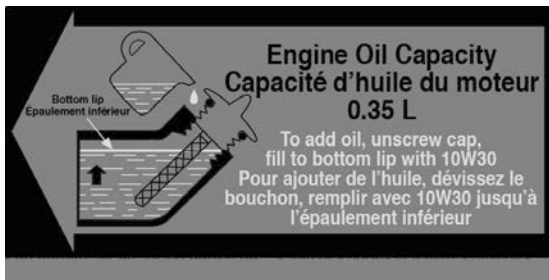

Figure 1B

- 5) Reposition the oil gauge dipstick and tighten it by turning clockwise.

FUEL LEVEL

WARNING! Make sure there is enough fuel in the fuel tank before operating.

- 1) If it is necessary to add fuel, first make sure the engine is OFF and preferably cool, then open and remove the fuel cap (A) Fig.2 by turning it counterclockwise.
- 2) Make sure the fuel filter cup (B) is positioned inside the tank opening before refueling.
- 3) When refueling, keep in mind all safety precautions and make sure to add enough fuel based on usage. Fill tank with gasoline until you notice the fuel level coming up through the fuel filter cup, fill until it reaches approximately half way up the cup, be careful not to spill gasoline or to overfill the tank. A full tank will give you 5-6 hours of operation depending on the load. Use clean unleaded gasoline with a minimum of 87 octane. Do not mix oil with gasoline. Fuel tank capacity: 4.5 Litres.
- 4) **IMPORTANT:** Before operating generator, turn the fuel cap lever (C) Fig.2 to the "On" position to allow gas vapors to escape, preventing fuel vapor build-up in the gas tank. Once you have finished using the generator, turn the fuel cap lever to the "Off" position.

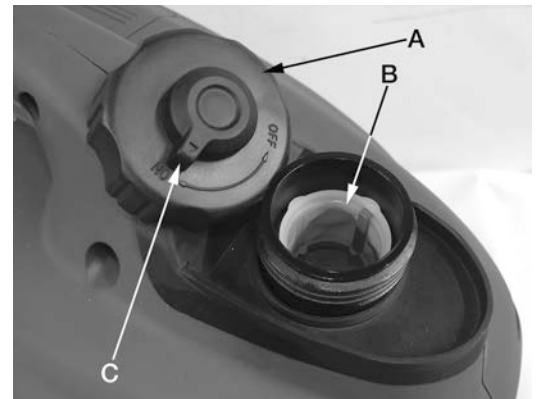

Figure 2

AIR CLEANER FILTER

WARNING! Never run the engine without the air cleaner filter installed. Rapid engine wear will result.

The air cleaner filter (A) Fig.3 should be checked before every start-up and after prolonged storage to make sure it is clean and in good condition. The following steps should be done when checking the air cleaner filter;

- 1) Remove the rear access cover.
- 2) Undo the large screw (B) Fig.3 and remove the air cleaner cover (C).
- 3) Remove the filter (A).
- 4) Wash filter in kerosene, squeeze kerosene out, soak filter in engine oil and squeeze engine oil out.
- 5) Reposition filter in air cleaner assembly (D), reinstall cover and secure it with the large screw.

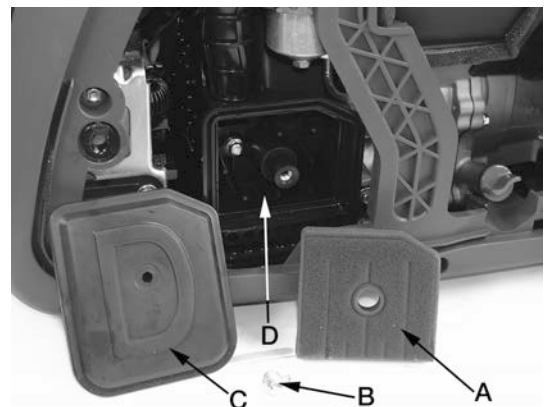

Figure 3



STARTING PROCEDURES

STARTING PROCEDURES

GROUNDING

WARNING! BEFORE STARTING, YOUR GENERATOR MUST BE GROUNDED!

Before operating make sure to ground the generator. A ground terminal (A) Fig.4 identified by the ground symbol can be found on the front control panel of the generator, attach a metal spike to a wire, attach the wire to the ground terminal and ground the metal spike into the earth. Your local electrical company or certified electrician should be able to help you with this information. See Fig.4.

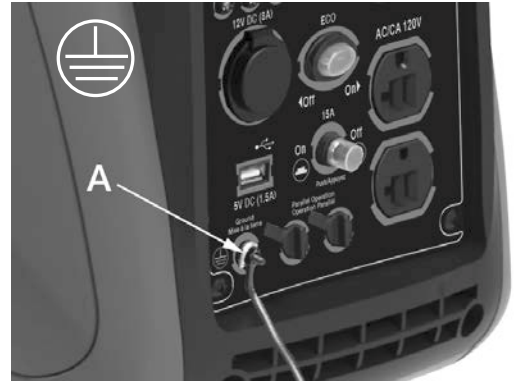

Figure 4

STARTING YOUR GENERATOR

WARNING! Do not adjust or attempt maintenance of engine without consulting an authorized service center. Never run engine indoors or in enclosed, poor ventilated areas, engine exhaust contains carbon monoxide, an odorless and deadly gas! Make sure all electrical appliances are unplugged before attempting to start generator!

To safely start your generator, follow each step below.

Check engine oil level, fill to recommended level if necessary



Pull recoil starter to start engine



Check gasoline level, fill if necessary. Turn cap to "On"

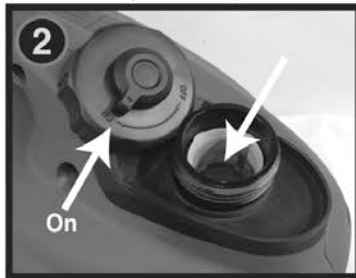

Move dial to "On" position



Disconnect all electrical devices and ground generator



Make sure power pilot light turns green



Move dial to "Choke" position



Connect electrical device(s) to receptacle(s)



Figure 5

Note: No choke is required on warm engines, simply place the dial to the "on" position and start generator. Pull the recoil starter handle until resistance is felt, then pull it out with a rapid full arm stroke. Let the starter rope rewind slowly, repeat if necessary. Allow generator to run at no load for 5 minutes upon each initial start-up to allow engine and generator to stabilize. **IF ENGINE OIL LEVEL IS TOO LOW, ENGINE WILL NOT START. CHECK OIL LEVEL AND ADD IF NECESSARY.**

On initial starts or seasonal starts, it may be necessary to pull the recoil starter a few times in order for the fuel to reach the carburetor.

STOPPING PROCEDURES & ELECTRICAL CONNECTIONS



STOPPING YOUR GENERATOR

Make sure all electrical appliances are unplugged before stopping the generator!

- 1) Turn the dial (A) Fig.6 to the "Off" position.
- 2) Turn the fuel cap lever (B) to the "Off" position.

ELECTRICAL CONNECTIONS

CONNECTING ELECTRICAL LOADS

Attempting to connect generator directly to the electrical system of any building structure.

Back feeding electricity through a building's electrical system to the outside utility feed lines could endanger repair persons attempting to restore service. Failure to use a double throw transfer switch when connecting to a structure's electrical system can damage appliances and WILL VOID the manufacturer's warranty. Never backfeed electricity through a structure's electrical system. To connect to a structure's electrical system in a safe manner, always have a Double-Throw Transfer Switch installed by a qualified electrician and in compliance with local ordinances. (When installing a Double-Throw Transfer Switch, a minimum of 10 gauge wiring must be used).

IMPROPER CONNECTION OF ITEMS TO GENERATOR

Exceeding the load capacity of the generator by attaching too many items, or items with very high load ratings to it could result in overheating of some items or their attachment wiring resulting in fire or electrical shock. Make sure that the sum total of electrical loads for all attachments does not exceed the load rating of the generator.

WARNING! Failure to connect and operate equipment in the sequence below can cause damage to equipment and will void the warranty. Let engine run and warm up for five minutes after starting with no electrical load. Connect loads in the following manner to prevent damage to equipment: Connect "inductive" load equipment first, inductive loads consist of refrigerators, freezers, water pumps, air conditioners, or small hand tools. Connect the items that require the most wattage first. Connect the lights next. Voltage sensitive equipment should be the last equipment connected to the generator. Plug voltage sensitive appliances such as TV's, VCR's, microwaves, ovens, computers, and cordless telephones. **Overloading the generator will cause power fluctuations and can damage equipment and appliances. King Canada will not be responsible for equipment damaged as a result of voltage surges, improper operation or improper installation of the generator.**

CONTROL PANEL

- **ON/CHOKE/OFF DIAL-(A) FIG.7.** On cold starts, turn dial to the Choke position before starting generator, once the generator starts turn dial to the On position. On warm starts turn dial to the On position. Turn dial to the Off position to turn generator off.
- **ECONOMICAL MODE SWITCH-(B) FIG.7.** When placed in the "On" position, the engine speed will be kept at idle automatically when an electrical load is disconnected and returns to proper speed to power the electrical load when reconnected. This is recommended to minimize fuel consumption during operation. Before using the electrical appliance, switch the Economical Mode switch to the "Off" position.
- **120V AC DUPLEX RECEPTACLE (C) FIG.7.** For normal 120V operation, plug your appliance or power bar into one of the duplex 120V receptacles.
- **15A RESET (D) FIG.7.** If an overload or short-circuit occurs, the Reset (D) Fig.7 or the internal overload sensor will "trip" to protect the circuit, causing the generator to automatically shut off. Disconnect all electrical items from the control panel. Press the tripped reset button and restart the generator.
- **PARALLEL CONNECTIVITY PORTS-(E) FIG.7.** It is possible to connect two identical inverter generators together using optional Parallel Cable Kit (Mod. K-X2P) for combined power output. Follow instructions provided with the optional Parallel Cord for more instructions.
- **GROUNDING TERMINAL-(F) FIG.7.** Attach cable to this terminal and ground to earth.
- **USB PORT-(G) FIG.7.** Connect USB powered devices for charging/operating purposes.
- **12V DC CIGARETTE LIGHTER SOCKET-(H) FIG.7.** Connect 12V DC powered devices for charging/operating purposes.

- **INDICATOR LIGHTS-(I, J, K) FIG.7.** The **Power** light (K-green) will remain on during normal operation. If the generator is overloaded or if there is a short in the connected appliance, the Power light (K) will turn off and the **Overload** light (J-red) will turn on, the electrical output will be stopped. **If this happens and the reset is still in the On position, this means the Internal Overload Sensor of the Digital Inverter has tripped the overload. Turn engine off, disconnect the load, wait a few seconds and restart engine.** When an electric motor is started, both the Overload (red) and the Power Output (green) may turn on simultaneously. The Overload red light will turn off after a few seconds. Constant overloads will shorten the life of the generator. The **Low Oil Warning** light (I-red) will turn on and the engine will not start if the engine oil level is too low. Add oil if this warning light turns on.

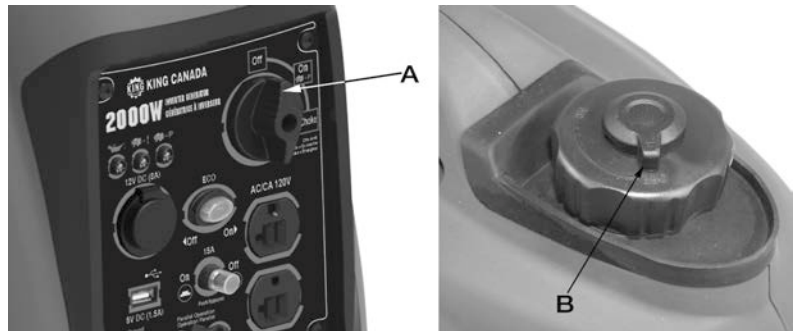

Figure 6

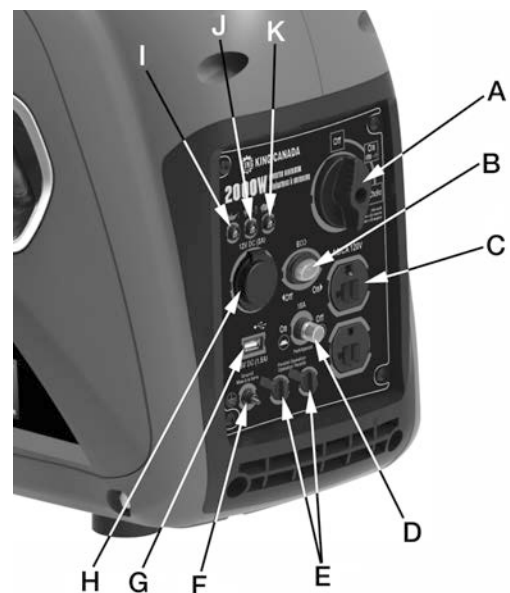

Figure 7



WATTAGE CALCULATIONS

WATTAGE CALCULATIONS

IMPORTANT! Never exceed the rated capacity of your generator. Serious damage to the generator or appliance could result from an overload.

- 1) "Starting" and "Running" wattage requirements should always be calculated when matching a generator's wattage capacity to the appliance or tool.
- 2) There are two types of electrical appliances that can be powered by your generator;
 - a) Items such as radios, light bulbs, television sets, and microwaves have a "resistive load". Starting wattage and running wattage are the same.
 - b) Items such as refrigerators, air compressors, washer, dryer and hand tools that use an electrical motor have an "inductive load". **Inductive load appliances and tools require approx. 2 to 3 times the listed wattage for "starting" the equipment.** This initial load only lasts for a few seconds on start-up but is important when figuring your total wattage to be used.

Always start your largest electric motor first, and then plug in other items, one at a time.

Wattage Requirement Chart below- This is only a guideline, each appliance or electrical device needs to be checked for its specific operating load.

DETERMINING WATTAGE REQUIREMENTS

Before operating this generator, list all of the appliances and/or tools that are going to operate at the same time. (Then determine the starting wattage requirements and the running wattage requirements by following the example below;

- 1) Add the total amount of the running wattage of all appliances and/or tools that will be operated at the same time.

Example 1A:

Lights = 100 Watts (Running)

Television = 135 Watts (Running)

TOTAL = 235 Watts (Running)

- 2) Next add the total amount of the starting wattage of any appliances and/or tools that will start and stop during operation.

Example 1B:

Small refrigerator 500 Watts (Running) 1600 Watts (Starting)

TOTAL = 500 Watts (Running) 1600 Watts (Starting)

- 3) The running wattage of examples 1A & 1B totals 735 watts. The starting wattage of the small refrigerator is 1600 watts which is 865 watts more than the running watts. Take this difference of 865 starting watts from the refrigerator and add to the total running watts of 735. Therefore:

865 Starting Watts + 735 Running Watts = 1600 Total Watts

The generator required to operate the items in example 1A & 1B must have a minimum capacity of at least 1600 starting watts.

Application	Wattage Required	
	Running	Peak Starting
Recreation/Camping		
Battery charging	120	120
Portable lighting	200	200
75W Light bulb	75	75
Coffee maker	900-1200	900-1200
Television (19")	65-110	65-110
Television (27")	115	115
Television (36")	135	135
Television (Flat screen)	120	120
VCR/DVD	15-20/20-25	15-20/20-25
Clock radio	10	10
Home		
Window air conditioner	500-1400	500-1400
Computer CPU	120	120
Computer monitor	150	150
Laptop	50	50
Electric range- 1 element	1500	1500
Electric blanket	60-300	60-300
Freezer	400	1000
Refridgerator	600	800-2000
Garage door opener (1/4HP)	550	1650
Microwave oven	750-1100	750-1100

MAINTENANCE



Engine Oil Replacement

Engine oil should be replaced after the first 20 hours of operation or after the first month of use, it should be replaced every 50 hours or 6 months after. To replace engine oil;

- 1) Open rear access panel, then loosen and remove the oil gauge dipstick (A) Fig.8.
- 2) Tilt the generator forward and drain the oil from the engine.

Recommended Engine Oil

It is recommended to use SAE 10W30 4-stroke gasoline engine oil. For cold weather (below -15°C) use SAE 5W30.

- 3) Using the supplied oil funnel, pour 0.35L (350ml) of clean engine oil through the oil gauge dipstick opening, fill then check oil level until the oil level reaches 3/4 up the dipstick or until it reaches the bottom lip of the dipstick hole.

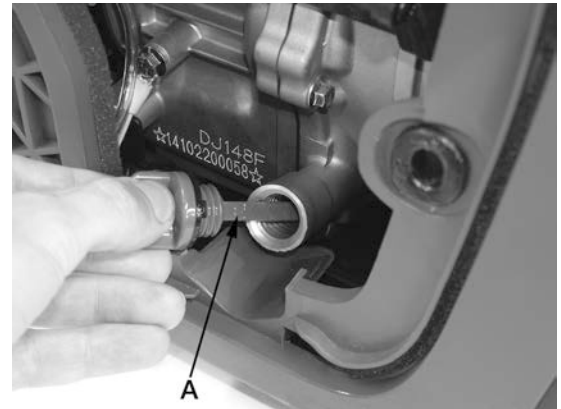

Figure 8

Inspecting, Replacing or Cleaning Spark Plug (NGK BPR6HS or equivalent)

The spark plug should be checked every 50 hours of operation or every 6 months. To replace or clean spark plug;

- 1) Open the top spark plug access cover.
- 2) Dismantle the spark plug cap (A) Fig.9 by pulling it off the spark plug. Using the supplied spark plug wrench, undo the spark plug (B) by turning it counterclockwise.
- 3) Check to see if there is carbon sediment build-up, if so just remove it. If the carbon sediment is excessive, replace the spark plug.
- 4) Measure the electrodes clearance. See Fig.10. The spark plug electrode clearance should be between 0.7-0.8mm. If the clearance exceeds 0.8mm, replace the spark plug with an NGK BPR6HS or equivalent.
- 5) Reinstall spark plug in the reverse order.

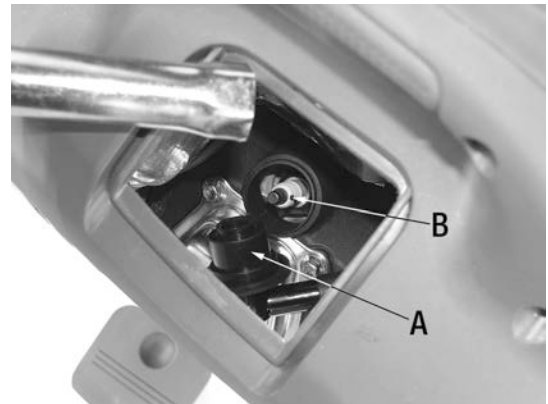

Figure 9

Muffler Spark Arrester Screen Maintenance

An uncleaned muffler spark arrester screen will produce louder noise levels and it will affect the engine running. If using this generator in dusty and dirty conditions, the muffler spark arrester screen (A) Fig.11 must be cleaned to prevent clogging of the exhaust fumes. To clean muffler spark arrester screen;

- 1) Make sure the generator is not running and has cooled down.
- 2) Undo the 6 pan head screws (B) Fig.11 and remove the muffler cover (C).
- 3) Undo the pan head screw (D) which secures the muffler spark arrester screen (A) to the muffler (E) and remove the spark arrester screen.
- 4) Inspect the spark arrester screen, remove it from the holder and clean with a metallic brush if it is necessary. If it is too difficult to clean, replace it.

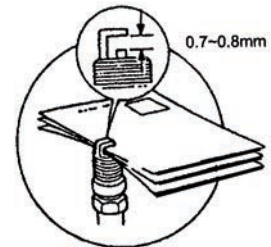

Figure 10

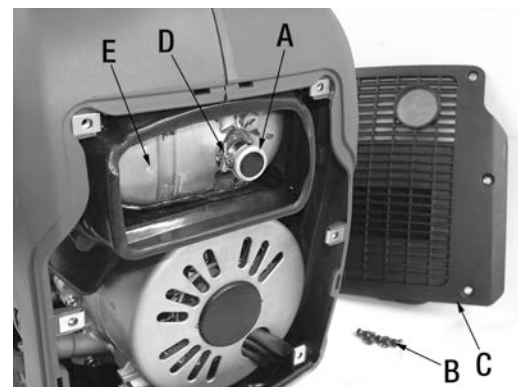

Figure 11



STORAGE & TROUBLESHOOTING

GENERATOR STORAGE

If you plan on storing your generator for an extended period of time, the following steps should be followed;

- 1) Add fuel stabilizer to fuel tank to minimize the formation of fuel gum deposits during storage.
- 2) Run engine at least 5 minutes after adding stabilizer to allow it to enter the fuel system.

NOTE: If a fuel stabilizer is not used, all gasoline must be drained from the tank and carburetor to prevent gum deposits from forming on these parts and causing possible malfunction of the engine. To drain gasoline;

- 3) Place carburetor drain pipe (A) Fig.12 over a drain container (B), make sure the drain container can hold up to 350ml.
- 4) Unscrew the fuel tank cap, then unscrew the spring loaded carburetor screw (C) using a phillips screwdriver. This will drain the fuel from the tank and the carburetor. Retighten the carburetor screw once the fuel is completely drained.
- 5) Drain engine oil from engine as described in "Engine Oil Replacement".
- 6) Pull the recoil starter handle gently until resistance is felt. At this point, the piston is coming up on its compression stroke and both intake and exhaust valves are closed. Storing engine in this position will help protect it from internal corrosion.

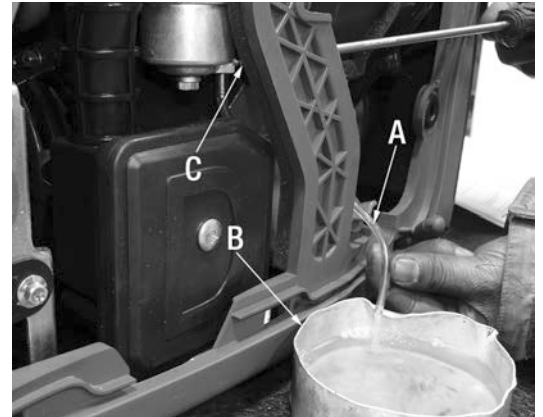

Figure 12

IF YOU ARE EXPERIENCING PROBLEMS, DO NOT RETURN TO THE RETAILER, CALL THIS TOLL-FREE NUMBER FOR SERVICE INFORMATION

1-877-636-4214

PROBLEM	CAUSE	CORRECTION
Engine will not start	<ol style="list-style-type: none"> 1. Low on fuel or oil. 2. Dial in "Off" position. 3. Faulty spark plug. 4. Choke in wrong position. 5. Unit loaded during start-up. 6. Spark plug wire loose. 	<ol style="list-style-type: none"> 1. Add fuel or oil. 2. Turn dial to "CHOKE" or "ON" position. 3. Replace spark plug. 4. Adjust choke accordingly. 5. Remove load from unit. 6. Attach wire to spark plug.
Engine is running but no AC output	<ol style="list-style-type: none"> 1. Faulty receptacle. 2. Reset tripped. 3. Defective capacitor. 	<ol style="list-style-type: none"> 1. Have Service Centre replace. 2. Reset by pressing button. 3. Have Service Centre replace capacitor.
Repeated reset tripping	<ol style="list-style-type: none"> 1. Overload. 2. Faulty cords or equipment. 	<ol style="list-style-type: none"> 1. Reduce load. 2. Check for damaged, bare, or frayed wires on equipment. Replace.
Generator overheating	<ol style="list-style-type: none"> 1. Generator overloaded. 2. Insufficient ventilation. 	<ol style="list-style-type: none"> 1. Reduce load. 2. Move to adequate supply of fresh air.
Engine runs well but gets bogged down when loads are connected	<ol style="list-style-type: none"> 1. Electrical short in connected item. 2. Overloaded. 	<ol style="list-style-type: none"> 1. Disconnect shorted load. 2. Reduce load.

PARTS DIAGRAM & PARTS LISTS

Refer to the Parts section of the King Canada web site for the most updated parts diagram and parts list.