



# KING CANADA

## 2 IN 1- 2" FLOORING STAPLER/ CLEAT NAILER KIT



MODEL: 8260FSN-2

# INSTRUCTION MANUAL

COPYRIGHT © 2007 ALL RIGHTS RESERVED BY KING CANADA TOOLS INC.



# WARRANTY INFORMATION

<b>2-YEAR LIMITED WARRANTY</b> 2 IN 1 FLOORING STAPLER/ CLEAT NAILER	<b>KING CANADA TOOLS</b> OFFERS A 2-YEAR LIMITED WARRANTY FOR NON-COMMERCIAL USE.
---	---

## **PROOF OF PURCHASE**

Please keep your dated proof of purchase for warranty and servicing purposes.

## **REPLACEMENT PARTS**

Replacement parts for this product are available at our authorized King Canada service centers across Canada.

## **LIMITED TOOL WARRANTY**

King Canada makes every effort to ensure that this product meets high quality and durability standards. King Canada warrants to the original retail consumer a 2-year limited warranty as of the date the product was purchased at retail and that each product is free from defects in materials. Warranty does not apply to defects due directly or indirectly to misuse, abuse, normal wear and tear, negligence or accidents, repairs done by an unauthorized service center, alterations and lack of maintenance. King Canada shall in no event be liable for death, injuries to persons or property or for incidental, special or consequential damages arising from the use of our products.

To take advantage of this limited warranty, return the product at your expense together with your dated proof of purchase to an authorized King Canada service center. Contact your retailer or visit our web site at [www.kingcanada.com](http://www.kingcanada.com) for an updated listing of our authorized service centers. In cooperation with our authorized serviced center, King Canada will either repair or replace the product if any part or parts covered under this warranty which examination proves to be defective in workmanship or material during the warranty period.

**KING CANADA INC. DORVAL, QUÉBEC, CANADA H9P 2Y4**

**[www.kingcanada.com](http://www.kingcanada.com)**

# GETTING TO KNOW YOUR 2 IN 1 FLOORING STAPLER/NAILER

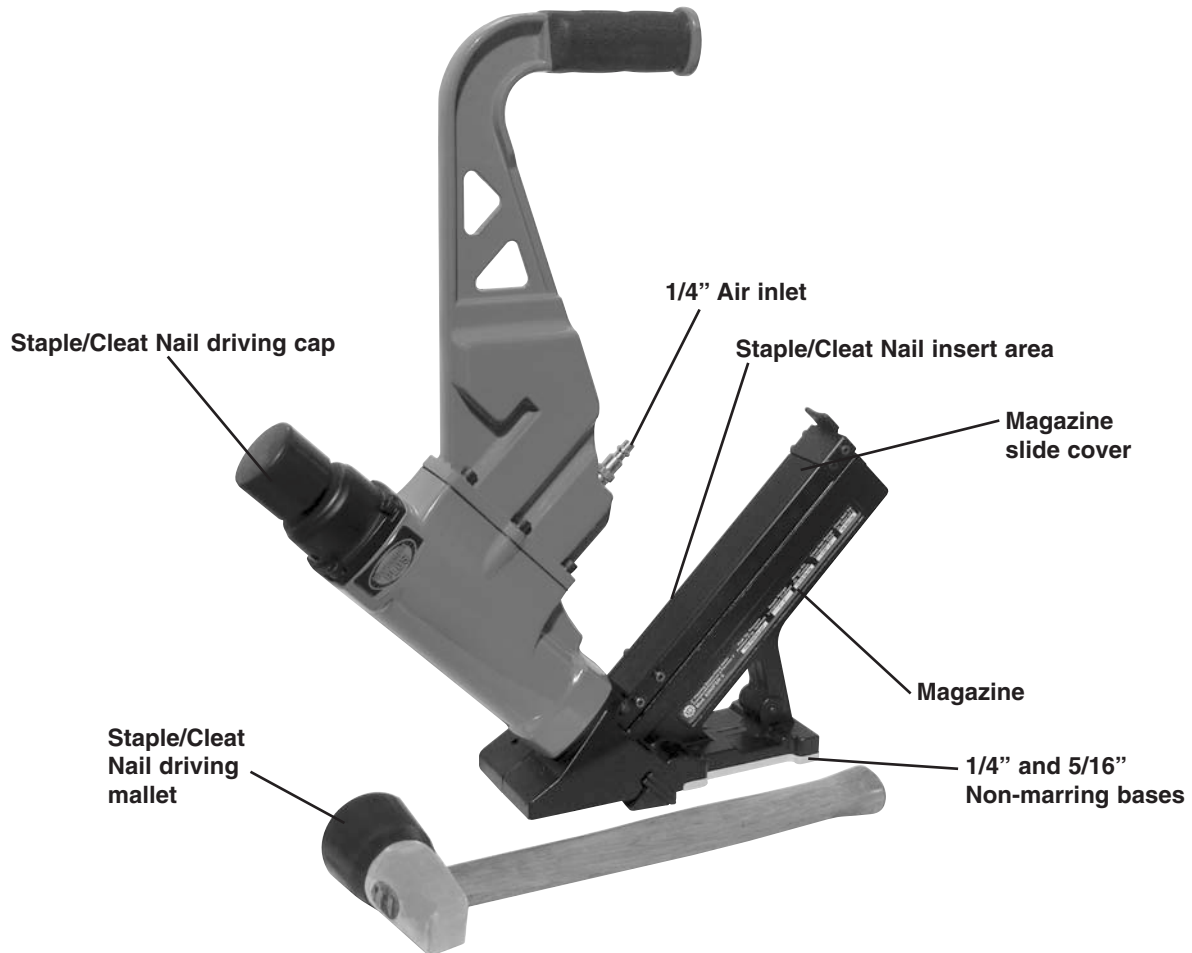

## SPECIFICATIONS

<b>Model</b> .....	8260FSN-2
Air inlet .....	1/4" NPT
<b>Compressed air:</b>	
Maximum permissible operating pressure .....	120 PSIG (8.3 bar)
Recommended operating pressure range .....	60-100 PSI
Operating pressure for peak performance .....	100 PSI
Staple range .....	15-1/2ga. x 1/2" crown staples from 1" to 2"
Magazine capacity .....	60 staples
Cleat Nail range .....	16ga. cleat nails from 1-1/2" to 2"
Magazine capacity.....	60 cleat nails

- Features:
- Powerful flooring stapler/nailer drives standard 15-1/2 ga. x 1/2" crown staples from 1" to 2" and standard 16 ga. cleat nails from 1-1/2" to 2"
  - Lightweight die-cast aluminum body reduces fatigue
  - Special one piece hardened driver for long, trouble-free performance
  - Composite non-marring base is designed to reduce scratches and damage to the surface of the wood
  - Additional composite non-marring base to suit a variety of flooring thicknesses
  - 60-100 PSI operating pressure
  - Comes with mallet, additional composite non-marring base, 1/4" air inlet, safety glasses, oiler, hex. keys & sturdy carrying case



# SAFETY INSTRUCTIONS

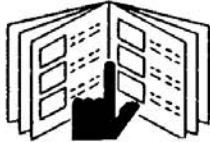

- Read and understand this manual and all the safety instructions before operating this flooring stapler/nailer. If you have any questions, please contact our authorized service centres or retailers for help.



- Never allow the use of flammable gases as a power source for the flooring stapler/nailer. Use filtered, lubricated and regulated compressed air only.



- Never use gasoline or other flammable liquids to clean this flooring stapler/nailer. Vapors in the flooring stapler/nailer will ignite by a spark and cause the flooring stapler/nailer to explode.



- Do not exceed the maximum permissible operating pressure of this flooring stapler/nailer (100 PSI).

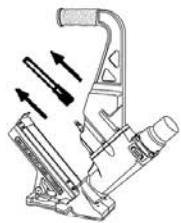

- Disconnect the flooring stapler/nailer from its air supply before clearing jams, servicing, adjusting and while the flooring stapler/nailer is not in use.



- At the workplace, always wear protective equipment such as Z87 safety glasses, hearing and head protection.



- Do not use a check valve or any other fitting which allows air to remain in the flooring stapler/nailer.



- Do not place your hand or any part of your body in the staple/nail discharge area of the flooring stapler/nailer when connecting or disconnecting from the air supply.



- Never point any operational staple/nail driving tool at yourself or at any other person.

# LUBRICATION AIR SUPPLY AND CONNECTIONS



## LUBRICATION AND MAINTENANCE



- Your flooring stapler/nailer needs to be lubricated before and after the first time you use it.
- Disconnect the air supply from the flooring stapler/nailer before lubricating.
- Turn the flooring stapler/nailer so that the inlet is facing up and put **ONE DROP** of high speed spindle oil or oil without detergent into the air inlet. Never use detergent oil or additives. Operate the flooring stapler/nailer briefly after adding oil.
- Wipe off excessive oil at the exhaust. Excessive oil will damage O-rings of the flooring stapler/nailer. If an in-line oiler is used, manual lubrication through the air inlet is not required on a daily basis.

## AIR SUPPLY AND CONNECTIONS WARNING!

THE FOLLOWING ILLUSTRATION SHOWS THE CORRECT MODE OF CONNECTION TO THE AIR SUPPLY SYSTEM WHICH WILL INCREASE THE EFFICIENCY AND USEFUL LIFE OF THE FLOORING STAPLER/NAILER.

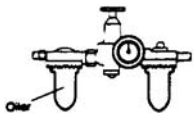
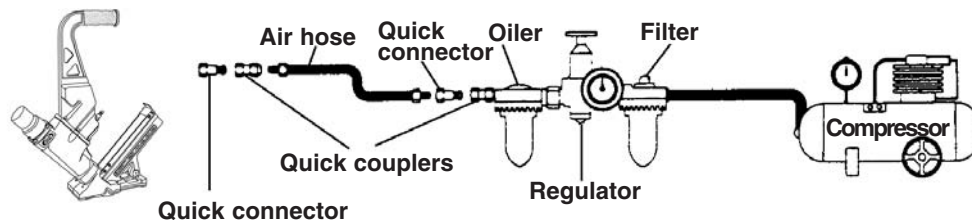

- Many air tool users find it convenient to use an oiler to help provide oil circulation through the tool and it increases the efficiency and useful life of the tool. Check oil level in the oiler daily.

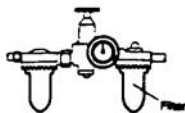

- Many air tool users find it convenient to use a filter to remove moisture and impurities which can rust or wear internal parts of the tool. A filter also increases the efficiency and useful life of the tool. The filter must be checked on a daily basis and, if necessary, drained.



- For better performance, install a 3/8" quick connector (1/4" NPT threads) with an inside diameter of .315" on your tool and a 3/8" quick coupler on the air hose.



# LOADING FLOORING STAPLER/NAILER & CLEARING JAMS

## LOADING FLOORING STAPLER/NAILER MAGAZINE



- Disconnect the air hose from the flooring stapler/nailer air inlet.
- Pull all the way back on the magazine sliding cover until it latches.
- Place a stick of 1/2" crown staples over the hanging rail of the magazine so that the legs of the staples straddle or a stick of cleat nails against either side of the hanging rail of the magazine.
- Push the magazine sliding cover forward to close.

## CLEARING JAMS

**Disconnect the flooring stapler/nailer from the air compressor before adjusting, clearing jams, servicing, relocating and during non-operation.**



- Disconnect the air hose from the flooring stapler/nailer air inlet.
- Pull all the way back on the magazine sliding cover until it latches and remove all staples or nails. You might be able to see and remove the jammed staple or nail from inside the magazine using pliers.
- If it is impossible to remove the jammed staple or nail from inside the magazine, then you will need to gain access to the discharge area, the entire discharge area must be disassembled. Place the flooring stapler/nailer on its side and remove the 2 cap screws (A) which hold the protective block (B), then remove the 3 cap screws (C) which hold the driver guide plate and gate assembly (D). Pull the driver guide plate and gate assembly apart and remove the jammed staple or nail using pliers. Reposition the driver guide plate and gate assembly and reinstall all parts in reverse order.

# OPERATING YOUR FLOORING STAPLER/NAILER



## OPERATING YOUR FLOORING STAPLER/NAILER

**WARNING!** protect your eyes and ears. Wear Z87 safety glasses with side shields. Wear hearing protection. Employers are responsible for ensuring the user or anyone near the flooring stapler/nailer wears the above mentioned safety protection.



**WARNING!** Check and replace any damaged or worn components.



- Add one/two drops of 30W oil for air tools into the air inlet.



- Install a quick connect fitting to the flooring stapler/nailer.

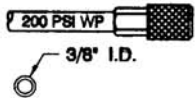

- Connect the flooring stapler/nailer to an air compressor using a 3/8" I.D. hose. Make sure the magazine does not contain any staples or nails and that the air hose has a rated working pressure exceeding 200 psi and a female quick coupler.



- For peak performance, regulate the air compressor air pressure at 100 psi.

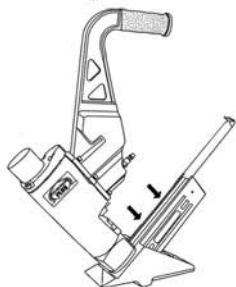

- Load magazine with staples or nails following the instructions in this manual.

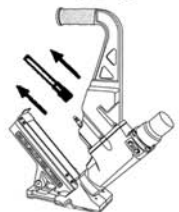

- Reconnect the air hose to the flooring stapler/nailer air inlet.

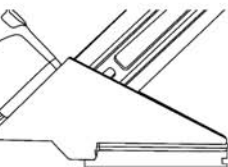

- Place the nose of the flooring stapler/nailer on the workpiece, make sure the non-marring base is flat on the workpiece. **First depress the trigger in the handle, then using the mallet, strike the driving cap to drive fastener into the workpiece.**

Note: This flooring stapler/nailer comes with 2 non-marring bases (1/4" & 5/16" thick). These bases reduce scratches and damage but they also allow you to set the height at which the staple penetrates your workpiece (1/16" adjustment) depending on the thickness of the floor and the position of the tongue.

**Warning!** It is not necessary to hit the driving cap hard to activate it, excessive force will damage the tool. The trigger is a safety device and should only be depressed when the tool is in the proper position on the work surface and before the driving cap is struck with the mallet. Remove your finger from the trigger when not driving fasteners.

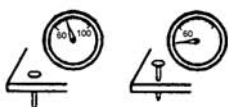

- Test for proper staple penetration, drive staples or nails into scrap flooring. If the staples or nails do not achieve the desired penetration, regulate the air pressure to a higher setting until the desired penetration is achieved. Do not exceed 100 psi.



# MAINTENANCE & TROUBLESHOOTING



## CLEANING YOUR FLOORING STAPLER/NAILER

- Never use gasoline or other flammable liquids to clean the flooring stapler/nailer. Vapors in the flooring stapler/nailer will ignite by a spark and cause the tool to explode and result in death or serious personal injury.
- Disconnect the air supply from the flooring stapler/nailer.
- Remove tar buildup with #2 kerosene fuel oil or diesel fuel. Do not allow solvent to get into the cylinder or damage may occur. Dry off the tool completely before use.

## TROUBLESHOOTING CHART

**WARNING: Stop using this tool immediately if any of the following problems occur. Serious personal injury could occur. Any repairs or replacements must be done by a qualified person or an authorized service center only.**

Problem	Cause	Solution
• Air leaking at trigger valve area.	• O-rings in trigger valve are damaged.	• O-rings must be replaced.
• Air leaking between housing and nose.	• Loose screws in housing. • Damaged O-rings.	• Screws need to be tightened. • O-rings must be replaced.
• Air leaking between housing and cap assembly.	• Damaged seal.	• Seal must be replaced.
• Flooring stapler/nailer skips a staple or nail.	• Worn bumper. • Dirt in flooring stapler/nailer nose. • Dirt or damage prevents fastener from moving freely in the magazine. • Inadequate air flow to flooring stapler/nailer. • Worn O-ring on piston or lack of lubrication. • Damaged O-rings on trigger valve. • Air leaks. • Cap seal is leaking.	• Bumper needs to be replaced. • Clean. • Magazine must be cleaned.  • Fitting hose and air compressor need to be checked. • O-rings must be replaced, lubricate.  • O-rings must be replaced. • Screws and fittings need to be tightened. • Seal needs to be replaced.
• Flooring stapler/nailer runs too slowly or has loss of power.	• Flooring stapler/nailer is not sufficiently lubricated. • Broken spring in cap assembly.	• Lubricate.  • Spring needs to be replaced.
• Jammed staple or nail.	• Driver guide worn or damaged. • Staples or nails are bent. • Magazine or nose screws are loose. • Damaged driver.	• Replace driver guide. • Replace with undamaged fasteners. • Screws need to be tightened. • Replace driver.

## REPLACEMENT DRIVER, BUMPER & O-RING REPAIR KITS

After prolonged use of your flooring stapler/nailer, the internal O-rings, Bumper & Driver may have to be replaced caused by wear & tear. To repair, a complete Driver, Bumper & O-ring Replacement Accessory Kit (model: KW-097) is available for your flooring stapler/nailer. Contact your local King Canada distributor for more information.

## PARTS DIAGRAM & PARTS LISTS

Refer to the Parts section of the King Canada web site for the most updated parts diagram and parts list.

