



OSCILLATING SPINDLE SANDER

04/2019



MODEL: KC-OVS-TL INSTRUCTION MANUAL

COPYRIGHT © 2014 ALL RIGHTS RESERVED BY KING CANADA TOOLS INC.



WARRANTY INFORMATION

**2-YEAR
LIMITED WARRANTY
FOR THIS OSCILLATING SPINDLE SANDER**

**KING CANADA TOOLS
OFFERS A 2-YEAR LIMITED WARRANTY
INTENDED FOR COMMERCIAL USE**

PROOF OF PURCHASE

Please keep your dated proof of purchase for warranty and servicing purposes.

REPLACEMENT PARTS

Replacement parts for this product are available at our authorized King Canada service centres across Canada.

LIMITED TOOL WARRANTY

King Canada makes every effort to ensure that this product meets high quality and durability standards. King Canada warrants to the original retail consumer a 2-year limited warranty as of the date the product was purchased at retail and that each product is free from defects in materials. Warranty does not apply to defects due directly or indirectly to misuse, abuse, normal wear and tear, negligence or accidents, repairs done by an unauthorized service centre, alterations and lack of maintenance. King Canada shall in no event be liable for death, injuries to persons or property or for incidental, special or consequential damages arising from the use of our products.

To take advantage of this limited warranty, return the product at your expense together with your dated proof of purchase to an authorized King Canada service centre. Contact your retailer or visit our web site at www.kingcanada.com for an updated listing of our authorized service centres. In cooperation with our authorized serviced centre, King Canada will either repair or replace the product if any part or parts covered under this warranty which examination proves to be defective in workmanship or material during the warranty period.

NOTE TO USER

This instruction manual is meant to serve as a guide only. Specifications and references are subject to change without prior notice.

KING CANADA INC. DORVAL, QUÉBEC, CANADA H9P 2Y4

www.kingcanada.com

GENERAL & SPECIFIC SAFETY RULES



1. KNOW YOUR TOOL

Read and understand the owners manual and labels affixed to the tool. Learn its application and limitations as well as its specific potential hazards.

2. GROUND THE TOOL.

This tool is equipped with an approved 3-conductor cord and a 3-prong grounding type plug to fit the proper grounding type receptacle. The green conductor in the cord is the grounding wire. **NEVER** connect the green wire to a live terminal.

3. KEEP GUARDS IN PLACE.

Keep in good working order, properly adjusted and aligned.

4. REMOVE ADJUSTING KEYS AND WRENCHES.

Form habit of checking to see that keys and adjusting wrenches are removed from tool before turning it on.

5. KEEP WORK AREA CLEAN.

Cluttered areas and benches invite accidents. Make sure the floor is clean and not slippery.

6. AVOID DANGEROUS ENVIRONMENT.

Don't use power tools in damp or wet locations or expose them to rain. Keep work area well lit and provide adequate surrounding work space.

7. KEEP CHILDREN AWAY.

All visitors should be kept a safe distance from work area.

8. MAKE WORKSHOP CHILD-PROOF.

-with padlocks, master switches or by removing starter keys.

9. USE PROPER SPEED.

A tool will do a better and safer job when operated at the proper speed.

10. USE RIGHT TOOL.

Don't force the tool or the attachment to do a job for which it was not designed.

11. WEAR PROPER APPAREL.

Do not wear loose clothing, gloves, neckties or jewelry (rings,

watch) because they could get caught in moving parts. Non-slip footwear is recommended. Wear protective hair covering to contain long hair. Roll up long sleeves above the elbows.

12. ALWAYS WEAR SAFETY GLASSES.

Always wear safety glasses (ANSI Z87.1). Everyday eye-glasses only have impact resistant lenses, they are **NOT** safety glasses. Also use a face or dust mask if cutting operation is dusty.

13. DON'T OVERREACH.

Keep proper footing and balance at all times.

14. MAINTAIN TOOL WITH CARE.

Keep tools sharp and clean for best and safest performance. Follow instructions for lubricating and changing accessories.

15. DISCONNECT TOOLS.

Before servicing, when changing accessories or attachments.

16. AVOID ACCIDENTAL STARTING.

Make sure the switch is in the "OFF" position before plugging in.

17. USE RECOMMENDED ACCESSORIES.

Consult the manual for recommended accessories. Follow the instructions that accompany the accessories. The use of improper accessories may cause hazards.

18. NEVER STAND ON TOOL.

Serious injury could occur if the tool tips over. Do not store materials such that it is necessary to stand on the tool to reach them.

19. CHECK DAMAGED PARTS.

Before further use of the tool, a guard or other parts that are damaged should be carefully checked to ensure that they will operate properly and perform their intended function. Check for alignment of moving parts, breakage of parts, mounting, and any other conditions that may affect its operation. A guard or other parts that are damaged should be properly repaired or replaced.

20. NEVER LEAVE MACHINE RUNNING UNATTENDED.

Turn power "OFF". Don't leave any tool running until it comes to a complete stop.

SPECIFIC SAFETY RULES FOR SPINDLE SANDERS

Safety is a combination of common sense, staying alert and knowing how your spindle sander works. Read and understand the following safety rules before operating.

1. For your own safety, read the entire instruction manual before operating the spindle sander.
2. Tighten all lock knobs or handles before operating.
3. Select a spindle that is smaller than the curve to be sanded.
4. Use an insert plate that comes closest to the spindle without touching it.
5. Make sure the spindle is properly positioned in taper sleeve socket using the wrench provided, tighten the nut. NOTE: Never over tighten; it may be difficult to remove the spindle later.
6. When table is positioned at any angle other than 90°, it is necessary to position the workpiece over the centerline.

7. Always lock the table with the lock knobs when setting at any angle.
8. Always loosen both table lock and tilting gear lock before changing the angle position of the table. Never force the table if it does not tilt easily, reason may be that the locks are still engaged. Never attempt to override the stop locks, this will cause damage to the tilting performance.
9. Before leaving the machine remove any particles or pieces left over, make sure the table is set at a 90° angle.



GETTING TO KNOW YOUR OSCILLATING SPINDLE SANDER

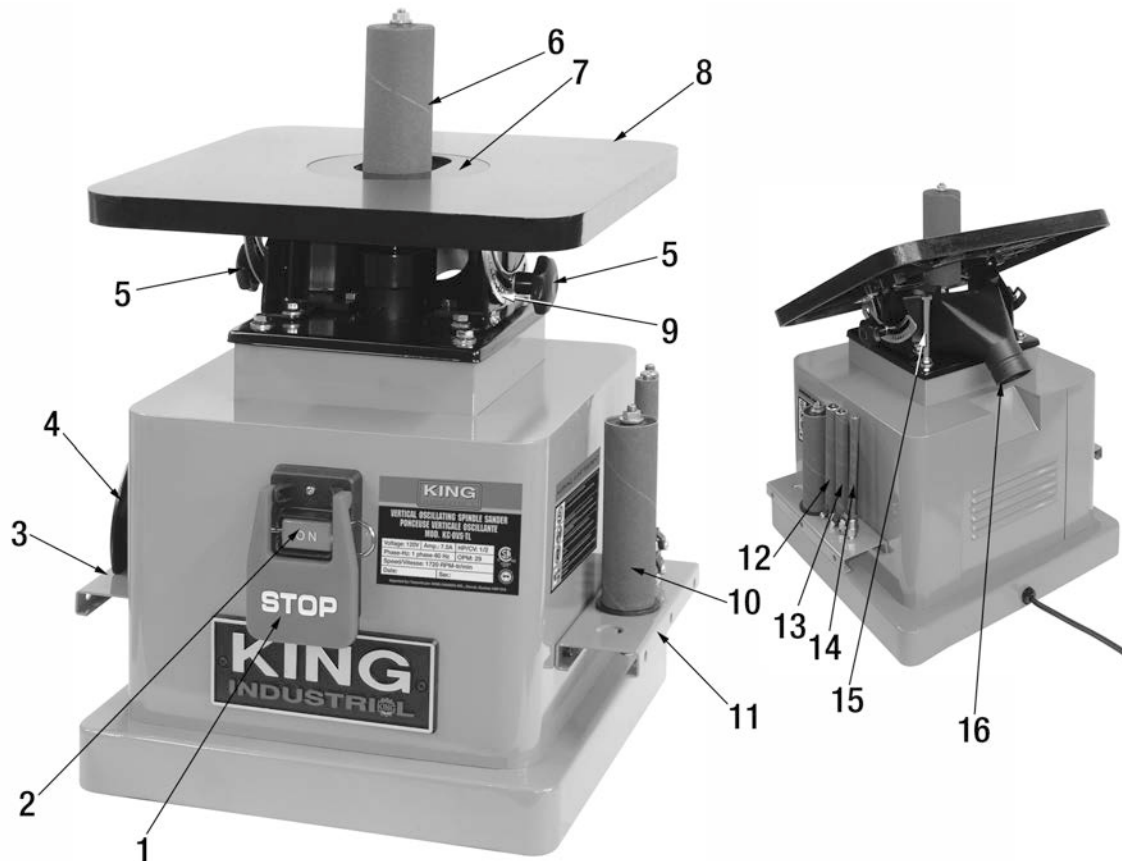

Getting to know your Spindle Sander

- | | |
|-----------------------------|---------------------------------------|
| 1) Emergency stop paddle | 9) Table tilt angle scale and pointer |
| 2) On button | 10) 1-1/2" sanding drum |
| 3) Table insert storage | 11) Sanding drum and sleeve storage |
| 4) 1 of 3 table inserts | 12) 5/8" sanding sleeve |
| 5) Table tilt lock knob | 13) 1/2" sanding sleeve |
| 6) 2" sanding drum | 14) 1/4" sanding sleeve |
| 7) Table insert (installed) | 15) 90° stop bolt |
| 8) Tilting table | 16) 2" dust hood |

Spindle Sander Specifications

MODEL	KC-OVS-TL
Oscillations per minute	29
Oscillations stroke	15/16"
Spindle drum diameter	1 1/2" - 2"
Spindle diameter	1/4" - 1/2" - 5/8"
Spindle speed	1,720 RPM
Table size	14-3/4" x 14-3/4"
Dust hood outlet diameter	2"
Motor	7.5 Amp.
Voltage	120V, 1 phase, 60 Hz
Assembled dimensions (LxWxH)/weight	17-1/2" x 14-3/4" x 18-7/8" / 77 lbs
Package dimensions (LxWxH)/weight	17" x 17" x 21" / 82 lbs

ELECTRICAL INFORMATION



WARNING!

ALL ELECTRICAL CONNECTIONS MUST BE DONE BY A QUALIFIED ELECTRICIAN. FAILURE TO COMPLY MAY RESULT IN SERIOUS INJURY! ALL ADJUSTMENTS OR REPAIRS MUST BE DONE WITH THE MACHINE DISCONNECTED FROM THE POWER SOURCE. FAILURE TO COMPLY MAY RESULT IN SERIOUS INJURY!

POWER SUPPLY

WARNING: YOUR SPINDLE SANDER MUST BE CONNECTED TO A 110V-120V, 15-AMP CIRCUIT BREAKER. FAILURE TO CONNECT IN THIS WAY CAN RESULT IN INJURY FROM SHOCK OR FIRE.

GROUNDING

This spindle sander must be grounded. If it should malfunction or breakdown, grounding provides a path of least resistance for electric current, to reduce the risk of electric shock. This spindle sander is equipped with a cord having an equipment-grounding conductor and grounding plug. The plug must be plugged into an appropriate outlet that is properly installed and grounded in accordance with all local codes and ordinances.

Your spindle sander must be properly grounded. Not all outlets are properly grounded. If you are not sure if your outlet is properly grounded, have it checked by a qualified electrician.

WARNING: TO MAINTAIN PROPER GROUNDING OF YOUR SPINDLE SANDER, DO NOT REMOVE OR ALTER THE GROUNDING PRONG IN ANY MANNER.

WARNING: IF NOT PROPERLY GROUNDED, THIS SPINDLE SANDER CAN CAUSE ELECTRICAL SHOCK, PARTICULARLY WHEN USED IN DAMP LOCATIONS. TO AVOID SHOCK OR FIRE, IF THE POWER CORD IS WORN OR DAMAGED IN ANY WAY, HAVE IT REPLACED IMMEDIATELY.

110V-120V OPERATION

As received from the factory, your spindle sander is ready to run for 110V-120V operation. This spindle sander is intended for use on a circuit that has an outlet and a plug which looks like the one illustrated in Fig.1.

WARNING: DO NOT USE A TWO-PRONG ADAPTOR FOR THEY ARE NOT IN ACCORDANCE WITH LOCAL CODES AND ORDINANCES. NEVER USE IN CANADA.

EXTENSION CORDS

The use of any extension cord will cause some loss of power. Use the chart in Fig.2 to determine the minimum wire size (A.W.G-American Wire Gauge) extension cord. Use only 3-wire extension cords which have 3-prong grounding type plugs and 3-hole receptacles which accept the tool's plug.

For circuits that are further away from the electrical circuit box, the wire size must be increased proportionately in order to deliver ample voltage to the spindle sander motor. Refer to Fig.2 for wire length and size.

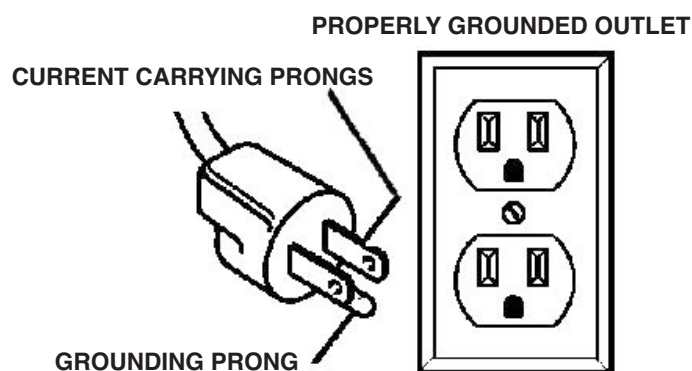

FIGURE 1

Tool's Amperage Rating	Cord Size in A.W.G.			
	Cord Length in Feet			
	25	50	100	150
3-6	18	16	16	14
6-8	18	16	14	12
8-10	18	16	14	12
10-12	18	16	14	12
12-16	14	12	-	-

FIGURE 2



ASSEMBLY & OPERATION

WARNING! IF ANY PART IS MISSING OR DAMAGED, DO NOT PLUG THE SPINDLE SANDER IN UNTIL YOU HAVE REPLACED THE MISSING OR DAMAGED PART. For your safety, complete the assembly of the spindle sander before plugging it into the power supply.

INSTALLING THE ON-BOARD STORAGE BRACKETS

1. Mount the drum/spindle on-board storage bracket (A) Fig.3 to either side of the spindle sander cabinet using 3 cap screws (B). To simplify the assembly, place the hex. key (C) through the front holes in the bracket to tighten each cap screw.
2. Repeat the above step for the table insert on-board storage bracket (D).

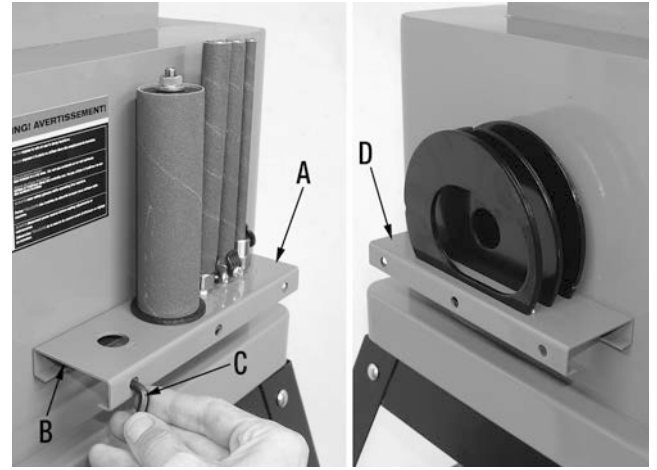

FIGURE 3

INSTALLING EMERGENCY STOP PADDLE TO SWITCH BRACKET

Make sure the power cord is unplugged from the power source before installing emergency stop paddle.

1. Install the emergency stop paddle (A) Fig.4 to the switch bracket (B) as shown.



FIGURE 4

ASSEMBLING SANDING SPINDLES AND DRUMS

1. For 1/4", 1/2", & 5/8" spindles, loosen the screw (A) Fig.5 on the bracket clamp (B) at the bottom of the spindle.
2. Slide the corresponding sanding sleeve fully onto the spindle. Note: the sanding sleeve must slide under the bracket clamp (B) Fig.5 as shown. Re-tighten the screw (A) on the bracket clamp (B) to secure the sanding sleeve. Pull on the sanding sleeve to make sure it is properly secured to the spindle.
3. For the 1-1/2" and 2" drum, slide the corresponding sanding sleeve onto the drum. Using the supplied 12mm open end wrench, tighten the nut (A) Fig.6 on the top of the drum by turning counterclockwise (reverse thread), this will secure the sanding sleeve. Pull on the sanding sleeve to make sure it is properly secured to the drum, if not tighten nut (A) another 1/2 turn.

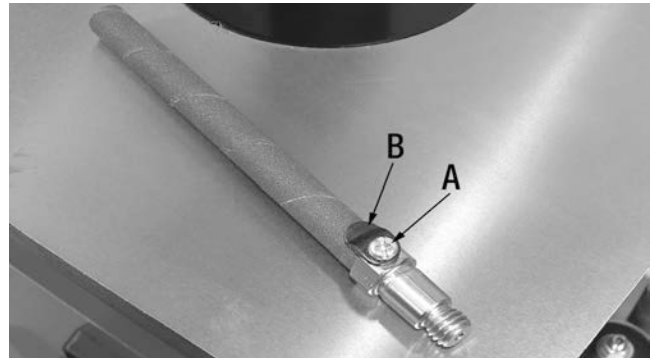

FIGURE 5

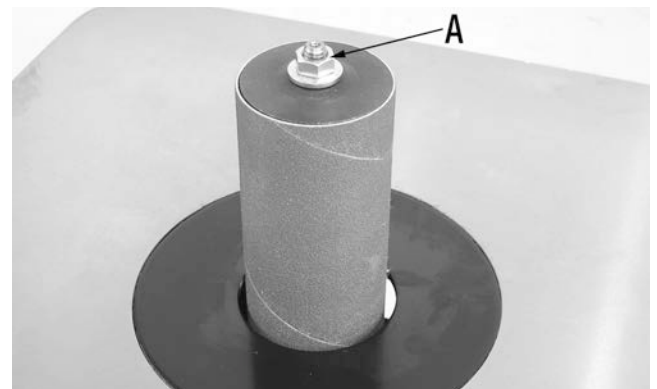

FIGURE 6

ASSEMBLY & ADJUSTMENTS



INSTALLING A SANDING SPINDLE OR DRUM

1. Make sure the spindle sander is disconnected from the power source.
2. Select the desired sanding spindle or sanding drum to install.
3. Clean the threaded shaft of the spindle or drum and the oscillating spindle opening before mounting.
4. Screw the threaded shaft of the sanding spindle or sanding drum in the counter-clockwise direction by hand into the oscillating spindle.
5. Place the supplied 17mm open end wrench (A) Fig.7 on the flat of the threaded shaft (B). At the same time, place another 17mm open-end wrench (C) on the flat of the oscillating spindle seat (D). Turn both open end wrenches towards each other to secure the sanding spindle or sanding drum.
6. Do not over tighten, this could make it very difficult to remove the sanding spindle or sanding drum after use.

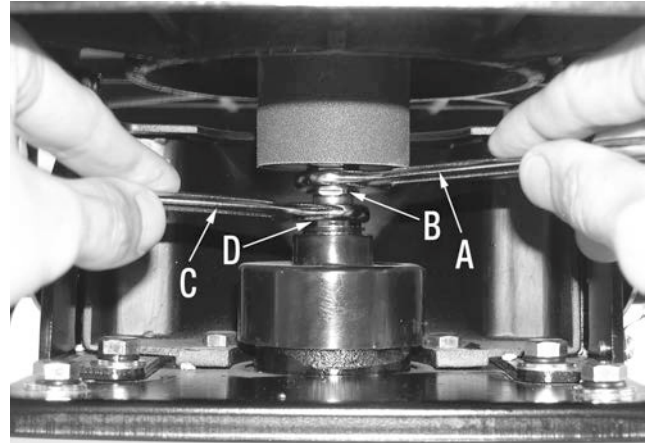

FIGURE 7

INSTALLING THE APPROPRIATE TABLE INSERT

FAILURE TO USE THE PROPER INSERT WITH THE CORRESPONDING SPINDLE MAY RESULT IN INJURY AND/OR DAMAGE TO THE MACHINE OR THE WORKPIECE.

1. This machine comes 4 table inserts. When changing spindles, the table insert will need to be changed to the matching size. Each table insert has a notch (A) Fig.8 to fit the alignment pin (B) in the table to ensure that it is properly fitted and installed in the table opening.
2. There are 2 table inserts with round openings (A & B) Fig.9 and 2 with oblong openings (C & D). The oblong table inserts are used when the table is tilted for bevel sanding.

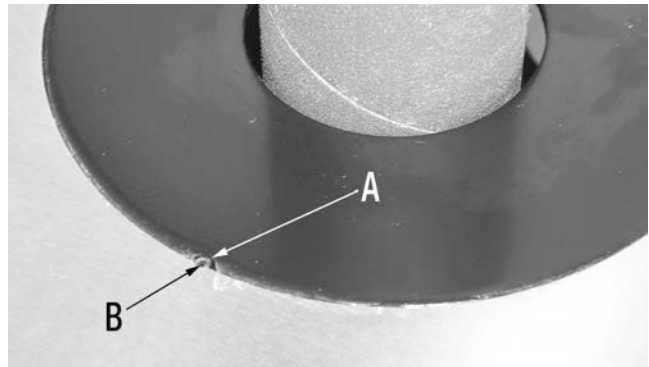

FIGURE 8

USING THE APPROPRIATE TABLE INSERT

SPINDLE/DRUM DIAMETER	TABLE INSERT (SHAPES)
1/4"	ROUND & OBLONG -SMALL (B & C) Fig.9
1/2"	ROUND & OBLONG -SMALL (B & C) Fig.9
5/8"	ROUND & OBLONG -SMALL (B & C) Fig.9
1-1/2"	ROUND & OBLONG -LARGE (A & D) Fig.9
2"	ROUND & OBLONG -LARGE (A & D) Fig.9

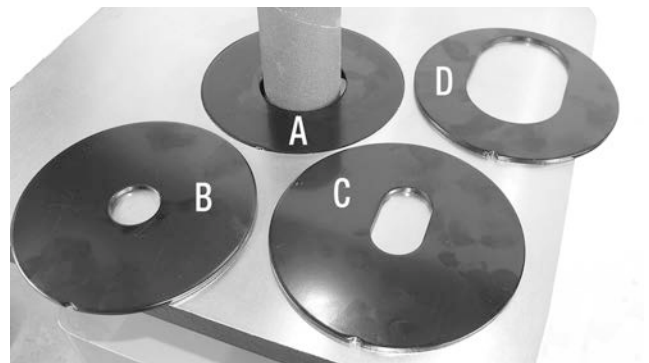

FIGURE 9

TILTING THE TABLE UP TO 45°

1. Loosen the two table lock knobs (A) Fig.10, located under the table on both sides of the sander.
2. Tilt the table forward to the desired angle with your hands.
3. An angle scale (B) and pointer (C) are provided at the right side of the trunnion to indicate the degree of table tilt.
4. Tighten the two table lock knobs securely after the table degree has been adjusted.

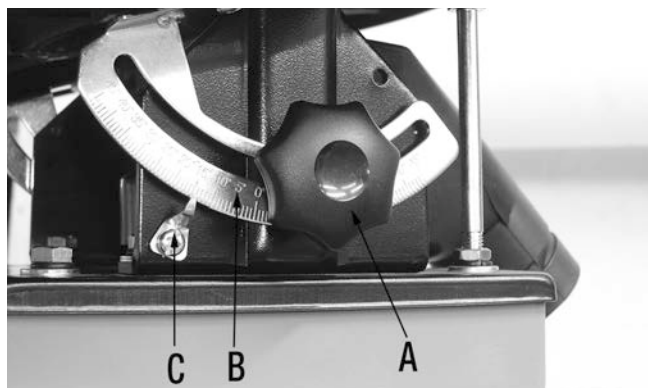

FIGURE 10



ADJUSTMENTS & OPERATION

SETTING THE TABLE SQUARE WITH THE SANDING SPINDLE/DRUM

The squareness between the table and sanding spindle/drum has been adjusted at the factory. However, after a long period of operation, the squareness may become inaccurate. To adjust table square with sanding spindle/drum;

1. Set the table to a flat horizontal position. The table tilting scale (A) Fig.11 should read zero degrees.
2. Place a 90° combination square on the table and against the drum.
3. If the table is not 90° to the drum, adjust the angle of the table by changing the height of the stop bolt (B).
4. If the table is 90° to the drum, but the scale (A) does not read zero degree, set the scale to read zero degree by loosening the screw (C) on the angle pointer (D) and setting pointer to zero.

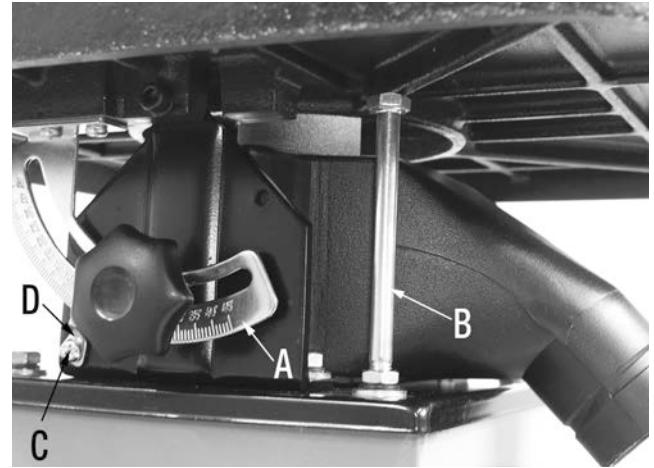

FIGURE 11

TURNING THE SANDER ON/OFF

This sander comes with a magnetic switch (A) Fig.12 which starts and stops the machine. To turn the sander on, lift the stop paddle (B) and press the green On button (C). To stop the sander, simply press the Off stop paddle (B).

This switch comes with a locking pin (A) Fig.13 to avoid accidental starts, this pin should be in position when sander is not in use. To avoid accidental starts by young children or others not qualified to use this sander, it is highly recommended to use a padlock instead. Keep the padlock key in a safe place out of the reach of children.



FIGURE 12

DUST COLLECTION

This sander comes with a 2" dust chute (A) Fig.14. at the rear of the machine allowing for the connection to a shop vacuum or with the combination of a 2" to 4" hose adaptor for connection to a dust collector.

Be sure to use appropriate size hose and fittings (not included) and check that all connections are sealed tightly to minimize airborne dust.

BASIC OPERATION

1. Select and install a sanding spindle/drum that is smaller than the curve to be sanded.
2. Use an appropriate table insert plate that comes closest to the sanding spindle/drum without touching it.
3. Make sure that sanding spindle/drum is properly installed in the spindle seat. With the supplied wrenches tighten the nut slightly beyond hand-tight. NOTE: Spindle threads are reversed. Turn clockwise to loosen and counterclockwise to tighten. Never overtighten, it may be difficult to remove later.
4. When table is set at a 90° angle, sanding may be done from any corner on the table. When the table is positioned at any angle other than 90°, sanding should only be performed with the workpiece positioned below the centre point of the table.
5. Make sure the table tilt lock knobs are secured at the desired angle or tilt.
6. Hold the workpiece firmly and work from a stable standing position.
7. To achieve the best finish results and to ensure maximum sanding sleeve life, slowly move the workpiece back and forth across the entire surface of the sanding spindle/drum.



FIGURE 13



FIGURE 14

MAINTENANCE & TROUBLESHOOTING



WARNING! FOR YOUR OWN SAFETY, TURN THE SWITCH OFF AND REMOVE THE PLUG FROM THE POWER SOURCE BEFORE PERFORMING MAINTENANCE, CLEANING OR LUBRICATION WORK ON THE SPINDLE SANDER.

CLEANING / LUBRICATING

1. Blow out dust accumulation and wood chips inside the motor, housing, and dust chute frequently.
2. A coat of automotive wax applied to the table will help keep the surface clean, it will also ensure that moisture from the wood does not remain on bare metal surfaces which can cause rust.
3. Periodic lubrication of handles and threaded parts will make these parts easier to operate.
4. Clean sanding spindles and drums and tapered socket before use, this will protect sanding spindles and drums from nicks.
5. We recommend that a small amount of grease be applied to the table tilting screw once a month.
6. No lubrication is required for the bearings, they are permanently lubricated.

TROUBLESHOOTING

PROBLEM	SOLUTION
Motor does not run when power switch is turned "ON".	<ol style="list-style-type: none">1. Switch is burned out. Replace the switch.2. Connection wire is loose or damaged. Tighten or replace the wire.
Motor does not run at full speed.	<ol style="list-style-type: none">1. Power voltage is too low. Test voltage.2. Motor is damaged. Check and repair motor.
Motor does not reach full power.	<ol style="list-style-type: none">1. Incorrect power wiring. Replace with the correct size power wiring.2. Overload. Reduce sanding load.
Motor overheating	<ol style="list-style-type: none">1. Motor is dirty. Clean motor.2. Motor is damaged. Check and repair motor.
Excessive machine vibration	<ol style="list-style-type: none">1. Machine is incorrectly leveled. Adjust machine leveling
Mark on workpiece	<ol style="list-style-type: none">1. Sanding drum is damaged. Replace the sanding drum.2. Sanding sleeve on drum is worn in some areas. Replace sanding sleeve.
Sanding drum turns in wrong direction	<ol style="list-style-type: none">1. Wrong phase or voltage. Make sure the phase and voltage comply with machine requirement.
Burns on workpiece	<ol style="list-style-type: none">1. Wrong abrasive grit on sanding sleeve. Use coarser grit to remove more material from workpiece.

PARTS DIAGRAM & PARTS LISTS

Refer to the Parts section of the King Canada web site for the most updated parts diagram and parts list.