



2 HP 1200 CFM DUST COLLECTOR



MODEL: KC-3109C

INSTRUCTION MANUAL

COPYRIGHT © 2012 ALL RIGHTS RESERVED BY KING CANADA TOOLS INC.

WARRANTY INFORMATION



**2-YEAR
LIMITED WARRANTY
FOR THIS 2 HP DUST COLLECTOR**

**KING CANADA TOOLS
OFFERS A 2-YEAR LIMITED WARRANTY
FOR COMMERCIAL USE.**

PROOF OF PURCHASE

Please keep your dated proof of purchase for warranty and servicing purposes.

REPLACEMENT PARTS

Replacement parts for this product are available at our authorized King Canada service centers across Canada.

LIMITED TOOL WARRANTY

King Canada makes every effort to ensure that this product meets high quality and durability standards. King Canada warrants to the original retail consumer a 2-year limited warranty as of the date the product was purchased at retail and that each product is free from defects in materials. Warranty does not apply to defects due directly or indirectly to misuse, abuse, normal wear and tear, negligence or accidents, repairs done by an unauthorized service center, alterations and lack of maintenance. King Canada shall in no event be liable for death, injuries to persons or property or for incidental, special or consequential damages arising from the use of our products.

To take advantage of this limited warranty, return the product at your expense together with your dated proof of purchase to an authorized King Canada service center. Contact your retailer or visit our web site at www.kingcanada.com for an updated listing of our authorized service centers. In cooperation with our authorized serviced center, King Canada will either repair or replace the product if any part or parts covered under this warranty which examination proves to be defective in workmanship or material during the warranty period.

NOTE TO USER

This instruction manual is meant to serve as a guide only. Specifications and references are subject to change without prior notice.

PARTS DIAGRAM & PARTS LISTS

Refer to the Parts section of the King Canada web site for the most updated parts diagram and parts list.

KING CANADA INC. DORVAL, QUÉBEC, CANADA H9P 2Y4

www.kingcanada.com



GENERAL SAFETY INSTRUCTIONS FOR POWER TOOLS

1. KNOW YOUR TOOL

Read and understand the owners manual and labels affixed to the tool. Learn its application and limitations as well as its specific potential hazards.

2. GROUND THE TOOL.

This tool is equipped with an approved 3-conductor cord and a 3-prong grounding type plug to fit the proper grounding type receptacle. The green conductor in the cord is the grounding wire. **NEVER** connect the green wire to a live terminal.

3. KEEP GUARDS IN PLACE.

Keep in good working order, properly adjusted and aligned.

4. REMOVE ADJUSTING KEYS AND WRENCHES.

Form habit of checking to see that keys and adjusting wrenches are removed from tool before turning it on.

5. KEEP WORK AREA CLEAN.

Cluttered areas and benches invite accidents. Make sure the floor is clean and not slippery due to wax and sawdust build-up.

6. AVOID DANGEROUS ENVIRONMENT.

Don't use power tools in damp or wet locations or expose them to rain. Keep work area well lit and provide adequate surrounding work space.

7. KEEP CHILDREN AWAY.

All visitors should be kept a safe distance from work area.

8. MAKE WORKSHOP CHILD-PROOF.

-with padlocks, master switches or by removing starter keys.

9. USE PROPER SPEED.

A tool will do a better and safer job when operated at the proper speed.

10. USE RIGHT TOOL.

Don't force the tool or the attachment to do a job for which it was not designed.

11. WEAR PROPER APPAREL.

Do not wear loose clothing, gloves, neckties or jewelry (rings, watch) because they could get caught in moving parts. Non-slip footwear is recommended. Wear protective hair covering to contain long hair. Roll up long sleeves above the elbows.

12. ALWAYS WEAR SAFETY GLASSES.

Always wear safety glasses (ANSI Z87.1). Everyday eyeglasses only have impact resistant lenses, they are **NOT** safety glasses. Also use a face or dust mask if operation is dusty.

13. DON'T OVERREACH.

Keep proper footing and balance at all times.

14. MAINTAIN TOOL WITH CARE.

Keep tools sharp and clean for best and safest performance. Follow instructions for lubricating and changing accessories.

15. DISCONNECT TOOLS.

Before servicing, when changing accessories or attachments.

16. AVOID ACCIDENTAL STARTING.

Make sure the switch is in the "OFF" position before plugging in.

17. USE RECOMMENDED ACCESSORIES.

Consult the manual for recommended accessories. Follow the instructions that accompany the accessories. The use of improper accessories may cause hazards.

18. NEVER STAND ON TOOL.

Serious injury could occur if the tool tips over. Do not store materials such that it is necessary to stand on the tool to reach them.

19. CHECK DAMAGED PARTS.

Before further use of the tool, a guard or other parts that are damaged should be carefully checked to ensure that they will operate properly and perform their intended function. Check for alignment of moving parts, breakage of parts, mounting, and any other conditions that may affect its operation. A guard or other parts that are damaged should be properly repaired or replaced.

20. NEVER LEAVE MACHINE RUNNING UNATTENDED.

Turn power "OFF". Don't leave any tool running until it comes to a complete stop.

SPECIFIC SAFETY INSTRUCTIONS FOR YOUR DUST COLLECTOR

WARNING: To reduce the risk of fire, electric shock or injury:

1) Read and understand this owners manual and all the labels on the dust collector before operating. Use only as described in this manual. To avoid personal injury or damage to your dust collector, use only recommended accessories.

Sparks inside the electrical parts can ignite flammable vapors or dust. To avoid fire or explosion:

2) Do not vacuum or use this dust collector near flammable or combustible liquids, gases, gasoline or other fuels, lighter fluid, cleaners, oil-based paints, natural gas, hydrogen, or explosive dusts like coal dust, magnesium dust, grain dust or gun powder.

3) Do not vacuum anything that is burning or smoking, such as cigarettes, matches or hot ashes.

4) To avoid health hazards from vapors and dust, do not vacuum toxic materials.

5) Do not use or store near hazardous materials.

6) Do not use outdoors or on wet surfaces.

7) Place dust collector on a stable, level surface.

8) Keep vacuum hose and electric cord out of traffic areas.

9) Do not let the dust collector be used as a toy. Close attention is necessary when used by or near children.

10) Do not leave the dust collector plugged in. Unplug from the outlet when it is not in use and before servicing.

SPECIFIC SAFETY INSTRUCTIONS FOR YOUR DUST COLLECTOR



- 11) Use extra care when collecting dust on stairs.
- 12) To avoid injury from accidental starting, unplug power cord before changing or cleaning the filter/dust bag or the chip bag.
- 13) Do not use without the filter/dust bag and/or the chip bag in place.
- 14) Do not unplug by pulling on the cord. To unplug, grasp the plug, not the cord.
- 15) Turn off controls before turning off.
- 16) Do not use with damaged cord, plug or other parts. If your dust collector is not working as it should, has missing parts, has been dropped, damaged, left outdoors, or dropped into water, send for servicing.
- 17) Do not pull or carry by the cord, use cord as handle, close a door on cord, or pull cord around sharp edges or corners. Do not run your dust collector over the cord. Keep cord away from heated surfaces.
- 18) Do not handle the electrical plug with wet hands.
- 19) Do not put any objects into the ventilation openings. Do not vacuum with any ventilation opening blocked, keep free of dust, lint, hair or anything that may reduce the air flow.
- 20) Keep hair, loose clothing, fingers and all other parts of the body away from openings and moving parts.
- 21) Extension cords in poor condition or that are too small can pose fire and shock hazards. When using an extension cord, make sure it is in good condition.
- 22) Connect to properly grounded outlet only.

CAUTION: If using this dust collector to keep airborne wood dust in heavy usage within acceptable limits, you must regularly monitor airborne dust and maintain the dust collector to avoid exceeding dust limits. Each application is unique. Your maintenance schedule must therefore be tailored to your specific use.

Safety is a combination of common sense, staying alert and knowing how your dust collector works.

WARNING: TO AVOID MISTAKES THAT COULD RESULT IN SERIOUS, PERMANENT INJURY, DO NOT CONNECT THE POWER CORD UNTIL THE FOLLOWING STEPS HAVE BEEN

COMPLETED:

- 1) Assembly, mounting and alignment.
- 2) Learn the function and proper use of the "ON/OFF" switch.
- 3) Read and understand all instructions and operating procedures throughout the manual.

BEFORE EACH USE:

- 1) Inspect your dust collector. If any parts are missing, bent, or fail in any way, or any electrical components do not work properly, turn off the dust collector, remove the switch key and remove the power cord from the power supply. Replace damaged, missing or failed parts before using the dust collector again.
- 2) Plan your work to protect your eyes, hands, face, ears and body.
- 3) **WEAR SAFETY GOGGLES. "FORESIGHT IS BETTER THAN NO SIGHT"**. Wear safety goggles, not glasses, that comply with ANSI Z87.1. Operating any power tool can result in foreign objects being thrown into the eyes which can result in permanent eye damage.
- 4) When cleaning the dust collector bags, wear a dust mask.

This dust collector is specifically designed to capture sawdust and wood chips at the source. The fine dust is filtered by the upper dust bag while the heavier particles settle in the lower dust bag for easy removal. **DO NOT USE AS A VACUUM.**

CAUTION: The blower housing contains a high speed fan blade that can amputate fingers, grab loose clothing and neckties, or propel dust at high velocities. **DO NOT OPERATE WITHOUT ALL PARTS IN PLACE.**

Do not attempt to clean, remove dust bags or service while in operation. Disconnect from power source.

IMPORTANT NOTE: Static shocks are common in dry areas or when the relative humidity of the air is low. To reduce the frequency of static shocks in your home, the best remedy is to add moisture to the air with a console or installed humidifier.

SPECIFICATIONS

MOTOR

HORSEPOWER	2 HP
VOLTAGE	240V
AMPERAGE	9A
R.P.M	3450
Hz	60
PHASE	1
AIR SUCTION CAPACITY	1200 C.F.M.
HOSE DIAMETER5"
INLET HOSE DIAMETER4"
BAG QUANTITY & SIZE.....	2 @ 20" X 34-1/2"



ELECTRICAL INFORMATION

WARNING!

ALL ADJUSTMENTS OR REPAIRS MUST BE DONE WITH THE DUST COLLECTOR DISCONNECTED FROM THE POWER SOURCE. FAILURE TO COMPLY MAY RESULT IN SERIOUS INJURY!

GENERAL INFORMATION- 240V single phase operation

This dust collector comes with a 2 HP 240V single phase motor.

WARNING: YOUR DUST COLLECTOR MUST BE CONNECTED TO A 220V-240V, 1 PHASE ELECTRICAL SUPPLY. FAILURE TO CONNECT IN THIS WAY CAN RESULT IN INJURY FROM SHOCK OR FIRE.

This dust collector is intended for use on an electrical circuit that has an outlet and a plug which looks like the one illustrated in Fig.1.

WARNING: DO NOT USE A TWO-PRONG ADAPTOR FOR THEY ARE NOT IN ACCORDANCE WITH LOCAL CODES AND ORDINANCES. NEVER USE IN CANADA.

GROUNDING

Your dust collector must be properly grounded. Not all outlets are properly grounded. If you are not sure if your outlet is properly grounded, have it checked by a qualified electrician. If it should malfunction or breakdown, grounding provides a path of least resistance for electric current, to reduce the risk of electric shock. This dust collector is equipped with a cord having an equipment-grounding conductor and grounding plug. The plug must be plugged into an appropriate outlet that is properly installed and grounded in accordance with all local codes and ordinances.

WARNING: TO MAINTAIN PROPER GROUNDING OF YOUR DUST COLLECTOR, DO NOT REMOVE OR ALTER THE GROUNDING PRONG IN ANY MANNER.

WARNING: IF NOT PROPERLY GROUNDING, THIS DUST COLLECTOR CAN CAUSE ELECTRICAL SHOCK, PARTICULARLY WHEN USED IN DAMP LOCATIONS. TO AVOID SHOCK OR FIRE, IF THE POWER CORD IS WORN OR DAMAGED IN ANY WAY, HAVE IT REPLACED IMMEDIATELY.

EXTENSION CORDS

The use of an extension cord is generally not recommended for 220V-240V operation. The use of any extension cord will cause some loss of power. Use the table (Fig.2) to determine the minimum wire size (A.W.G-American Wire Gauge) extension cord needed. Use only 3-wire extension cords which have 3-prong grounding type plugs and 3-hole receptacles which accept the tool's plug.

For circuits that are further away from the electrical circuit box, the wire size must be increased proportionately in order to deliver ample voltage to the dust collector motor. Refer to Fig.2 for wire length and size.

ON/OFF SWITCH

On the side of the motor is the switch box. The ON/OFF switch (A) Fig.3 has the ability to be turned "ON" when the starter key (B) is properly installed. Switch to the "ON" position by moving the switch upward. To put the switch in the "OFF" position, move the switch downward. Remove the key from the switch whenever the dust collector is turned "OFF". Place the key in a safe place out of reach of children.

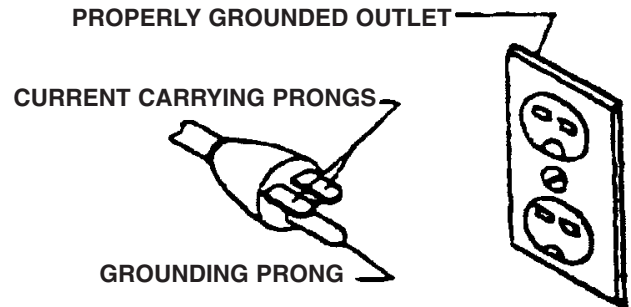
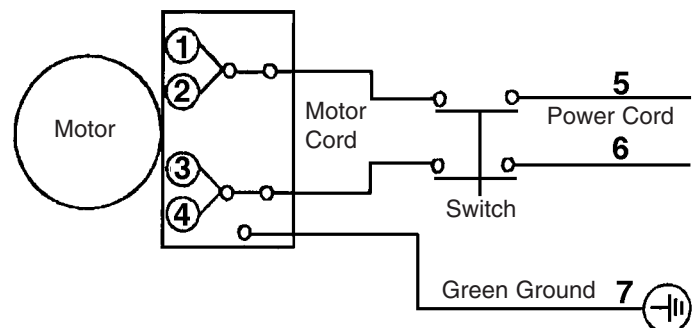

FIGURE 1

LENGTH OF EXTENSION CORD	WIRE SIZES REQUIRED (AMERICAN WIRE GAUGE) 240V LINES ONLY
0-25 FEET	NO.14
26-50 FEET	NO.12
51-100 FEET	NO.10

FIGURE 2



1- White
2- Yellow
3-White

4- Yellow
5- Black

6- White
7- Green Ground

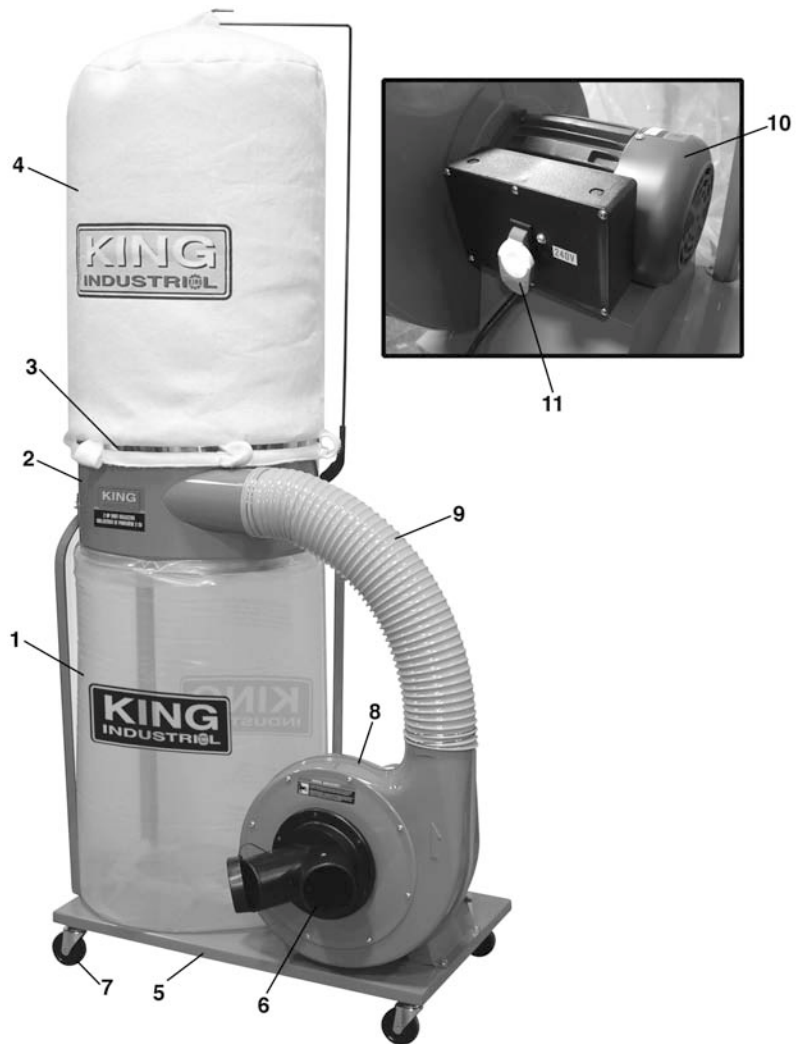

FIGURE 3

GETTING TO KNOW YOUR DUST COLLECTOR



1. Bottom dust collection bag
2. Housing
3. Dust bag strap
4. Top cloth filter bag (KC-3109C only)
5. Base plate
6. Inlet cover
7. Caster
8. Ventilation housing
9. Hose
10. Motor
11. On/Off switch



UNPACKING

1. Removing all the contents of the shipping carton.
2. Report any damage to your retailer.
3. Do not discard any shipping materials until after the dust collector has been assembled and is running properly.

Contents of the shipping carton (Fig.4)

- 1 Bag hanger
- 1 Base
- 1 Hanger bracket
- 1 Hose
- 3 Support brackets
- 1 Motor/fan assembly
- 1 Transparent bottom collection bag
- 1 Cloth upper filter bag (KC-3109C only)
- 2 Hose clamps
- 2 Retainer straps
- 1 Hardware bag
- 4 Casters
- 1 Inlet cover
- 1 Hose adapter

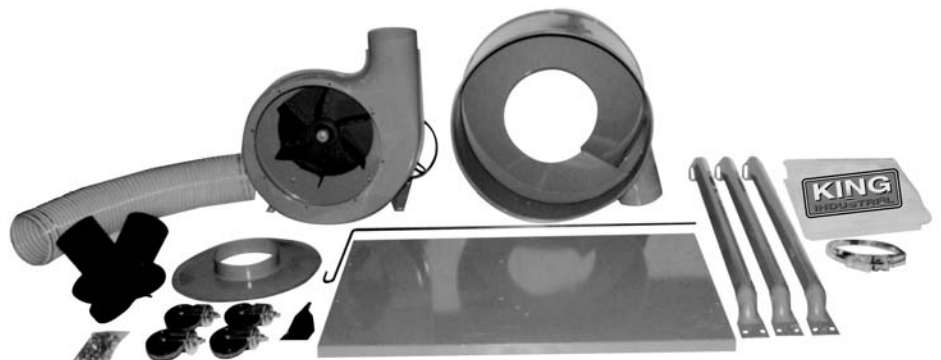

FIGURE 4

1. Install the four casters (A) Fig.5 to the under side of the base (B). Do not remove the lock washers and nuts from caster roller shafts; these act as spacers. Insert caster shaft into threaded hole on the underside of the base, turn until it is snug, then tighten nut with wrench.

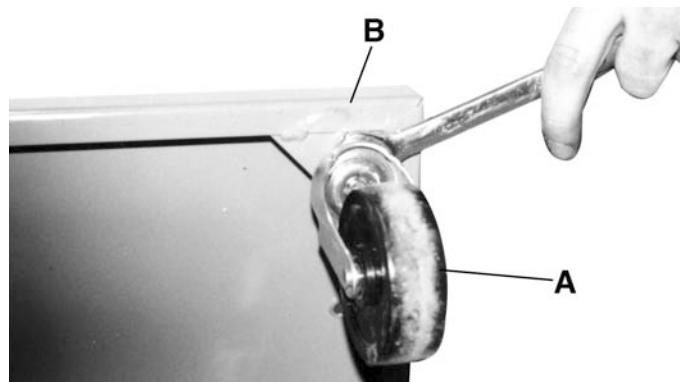

FIGURE 5

2. Place base with casters (A) Fig.6 on the ground and attach the motor and fan housing assembly (B) to the base using 4 hex. bolts and 4 flat washers.

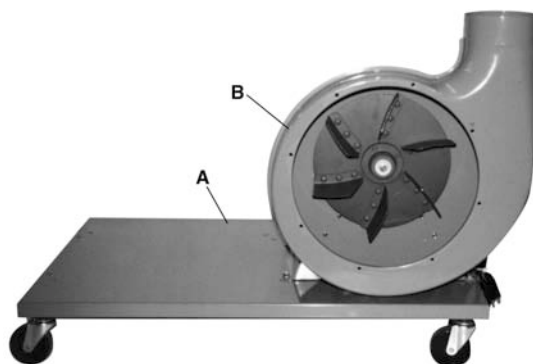

FIGURE 6

3. Attach inlet cover (A) Fig.7 to fan housing (B) using 8 pan hd screws.

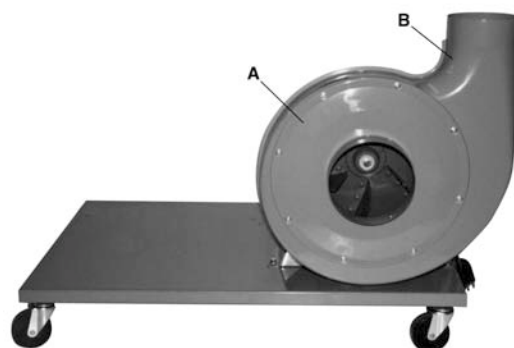

FIGURE 7

4. Attach the three support brackets (A) Fig.8 to the base (B) using 6 hex. bolts and 6 flat washers. Hand tighten only at this point.

5. Attach hose adapter (C) to inlet cover (D) by pressing it into the inlet cover opening.

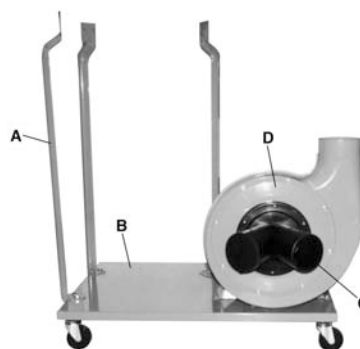

FIGURE 8

ASSEMBLY



6. Install housing (A) Fig.9 to three support brackets (B) using 6 hex. bolts, 12 flat washers and 6 hex. nuts. Make sure the hose opening (C) faces the fan housing (D). Before attaching the third support bracket, place hanger bracket (E) between the support bracket and the housing as shown (KC-3109C only). Tighten all bracket nuts and bolts at this time.

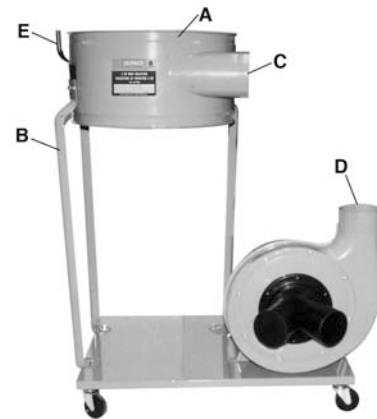

FIGURE 9

7. Slide hose clamps (A) Fig.10 onto each end of the hose (B). Attach hose between the fan housing (C) and the main housing (D). Tighten clamps to secure hose using a screwdriver.

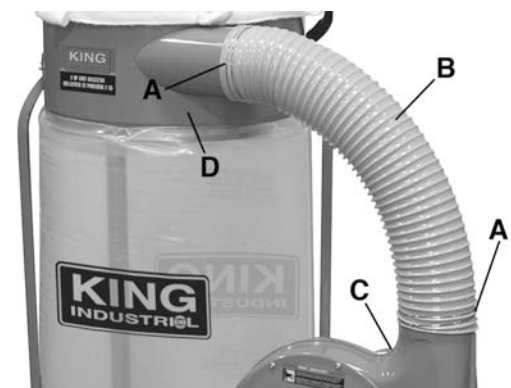

FIGURE 10

8. Insert bag hanger (A) Fig.11 into hanger bracket (B) and then hook the top dust bag to hanger. Insert retainer strap (C) through keeper straps of the top dust bag (D) and fasten to the upper lip of the main housing (E) (KC-3109C only).

9) Position the retainer strap (F) Fig.11 over the bottom transparent dust bag (G) and fasten to the lower lip of the main housing (H).

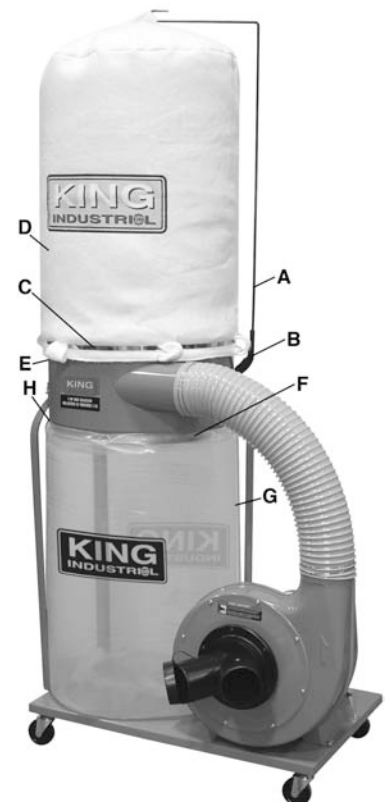

FIGURE 11



MAINTENANCE & TROUBLESHOOTING

MOTOR

Excessive dust in the motor could cause excessive heat. Every effort should be made to prevent foreign material from entering the motor. A visual inspection should be made at frequent intervals. Accumulations of dry dust can usually be blown out to prevent the interference with normal motor ventilation. To remove dust, blow off motor with a low pressure air hose.

CAUTION: TO AVOID INJURY OR ADVERSE REACTION TO DUST, A HIGH PRESSURE HOSE SHOULD NOT BE USED ESPECIALLY IN POORLY VENTILATED AREAS.

The operator performing this cleaning function should wear safety glasses and a filter mask. If any servicing (other than the above cleaning) becomes necessary, it should be performed by an authorized service centre.

Operational hints

During the first use and after cleaning, the upper filter bag may allow

some dust to escape. This is normal and will stop after a short period of time.

CAUTION: WEARING A PARTICLE MASK/RESPIRATOR FOR PROTECTION AGAINST FINE DUST PARTICLES DURING CLEANING IS HIGHLY RECOMMENDED.

Clean the upper filter bag frequently to keep the dust collectors' performance at its optimum. To clean:

1. Disconnect the machine from the power source.
2. Loosen the upper retaining strap, remove the bag from the housing.
3. Turn the bag inside out and shake vigorously.
4. Turn the bag inside in and reattach to the housing using the retainer strap to secure.
5. Connect the machine to the power source.

Use the proper type of hose to connect the dust collector to the machine being operated. A dryer vent hose is not acceptable for this purpose.

PROBLEM	PROBABLE CAUSE	REMEDY SUGGESTED
Motor will not run.	<ol style="list-style-type: none"> 1. Defective cord, plug, switch and/or motor. 2. Blown fuse. 	<ol style="list-style-type: none"> 1. Consult service. Any attempt to repair this motor may create a hazard unless repair is done by a qualified service technician. Repair service is available at your nearest service centre. 2. Check for blown fuses and replace with fuse of proper capacity.
Excessive sawdust in air.	<ol style="list-style-type: none"> 1. Loose connectors. 2. Filterbag and/or collection bag releasing sawdust. 	<ol style="list-style-type: none"> 1. Tighten connections. 2.a. Sawdust trapped between bag and housing. b. Reposition collection bag properly.
Excessive impeller noise.	<ol style="list-style-type: none"> 1. Picked up large wood chips and debris. 2. Loose impeller. 3. Rubbing impeller. 	<ol style="list-style-type: none"> 1. Do not pick up metal or ferrous materials. Stop the machine and the material will fall to the bottom of the inlet tube. 2. Unplug dust collector prior to disassembly. Hazardous moving parts inside. Attach inlet guard before plugging in. Use a piece of wood to free impeller. 3. Consult service to repair loose or rubbing impeller. A repair to the housing may create a hazard unless it is done by a qualified service technician. Servicing is available at your nearest service centre.
Excessive noise.	<ol style="list-style-type: none"> 1. Motor. 	<ol style="list-style-type: none"> 1. Have the motor checked by a qualified service technician.
Motor fails to develop full power. NOTE: LOW VOLTAGE (Power output of motor decreases rapidly with decrease in voltage at the motor terminals.	<ol style="list-style-type: none"> 1. Circuit overloaded with lights, appliances and other motors. 2. Undersized extension cord or extension cord is too long. 3. General overloading of power company facilities. 	<ol style="list-style-type: none"> 1. Do not use other appliances or motors on the same circuit as your dust collector. 2. Increase the wire size on extension cord, or reduce the length of the extension cord. 3. Request a power check from your power company.
Motor starts slowly or fails to come up to speed.	<ol style="list-style-type: none"> 1. Low voltage. 2. Windings are burned out or open. 3. Starting switch will not operate. Capacitor is bad. 	<ol style="list-style-type: none"> 1. Request voltage check from your power company. 2. Have motor repaired or replaced by a qualified service technician. 3. Have capacitor replaced by a qualified service technician.
Motor overheats	<ol style="list-style-type: none"> 1. Motor overloaded. 2. Improper cooling, air circulation is restricted through motor due to sawdust accumulation. 	<ol style="list-style-type: none"> 1. Clean out sawdust to provide normal air circulation through the motor. See "Maintenance" section above.