



KING KING CANADA

18 GA. X 2" BRAD NAILER



MODEL: 8201NL

INSTRUCTION MANUAL

COPYRIGHT © 2020 ALL RIGHTS RESERVED BY KING CANADA TOOLS INC.

WARRANTY INFORMATION



**2-YEAR
LIMITED WARRANTY
FOR THIS 18 GA. BRAD NAILER KIT**

**KING CANADA TOOLS
OFFERS A 2-YEAR LIMITED WARRANTY
FOR NON-COMMERCIAL USE.**

PROOF OF PURCHASE

Please keep your dated proof of purchase for warranty and servicing purposes.

REPLACEMENT PARTS

Replacement parts for this product are available at our authorized King Canada service centres across Canada. Please use the 10 digit part numbers listed in this manual for all part orders where applicable.

LIMITED TOOL WARRANTY

King Canada makes every effort to ensure that this product meets high quality and durability standards. King Canada warrants to the original retail consumer a 2-year limited warranty as of the date the product was purchased at retail and that each product is free from defects in materials. Warranty does not apply to defects due directly or indirectly to misuse, abuse, normal wear and tear, negligence or accidents, repairs done by an unauthorized service centre, alterations and lack of maintenance. King Canada shall in no event be liable for death, injuries to persons or property or for incidental, special or consequential damages arising from the use of our products.

To take advantage of this limited warranty, return the product at your expense together with your dated proof of purchase to an authorized King Canada service centre. Contact your retailer or visit our web site at www.kingcanada.com for an updated listing of our authorized service centres. In cooperation with our authorized service centre, King Canada will either repair or replace the product if any part or parts covered under this warranty which examination proves to be defective in workmanship or material during the warranty period.

NOTE TO USER

This instruction manual is meant to serve as a guide only. Specifications and references are subject to change without prior notice.

KING CANADA INC. DORVAL, QUÉBEC, CANADA H9P 2Y4

www.kingcanada.com



GETTING TO KNOW YOUR NAILER

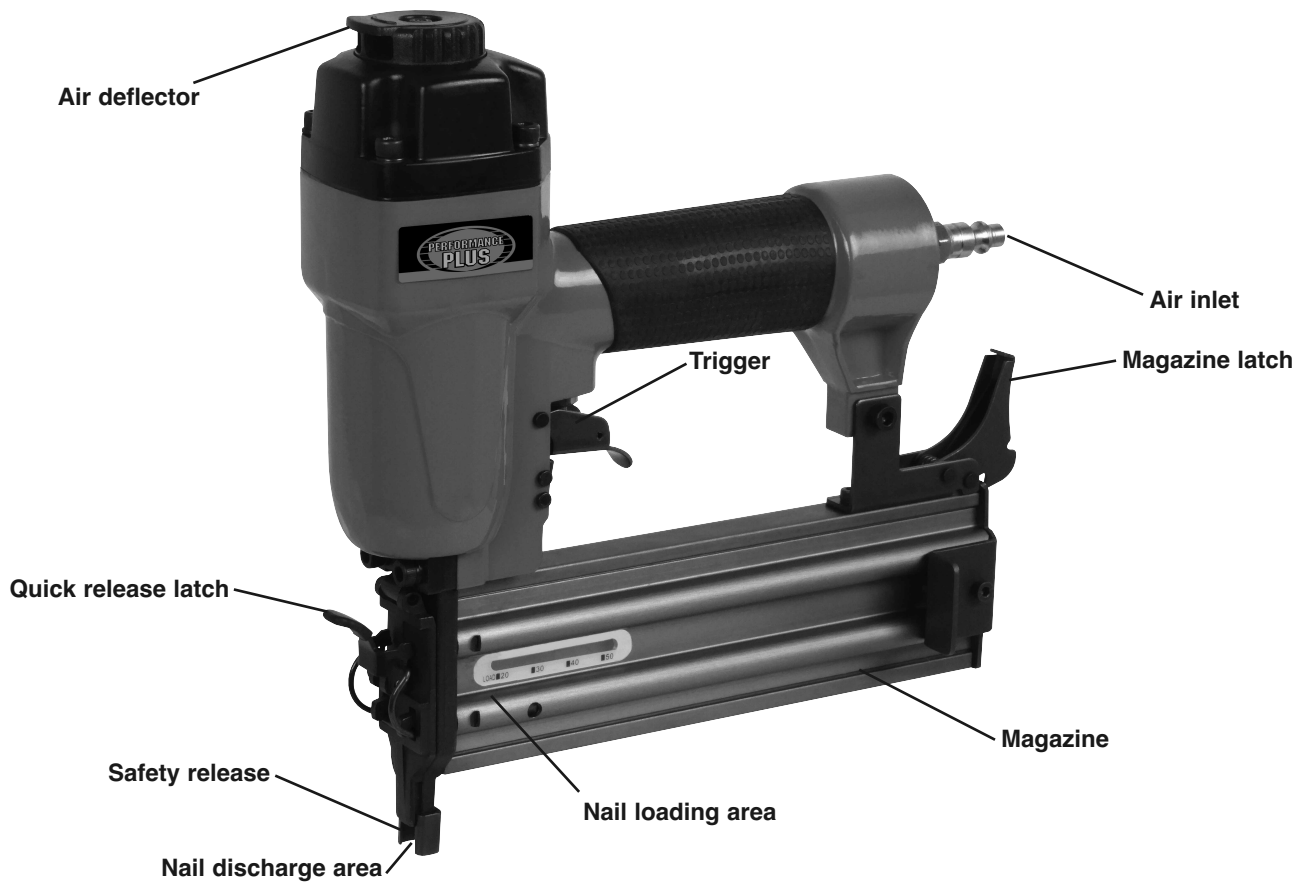

SPECIFICATIONS

Model	8201NL
Air inlet.....	1/4" NPT
Compressed air:	
Maximum permissible operating pressure	120 PSIG (8.3 bar)
Recommended operating pressure range	60-100 PSI
Nail range	3/4" to 2" 18 Ga. brad head finish nails
Width	1.25mm
Thickness2mm
Nail capacity	100 brad nails

A V A I L A B L E
KING INDUSTRIAL
18 GA. - BRAD NAILS

BN-1820	3/4"	(18MM APPROX.)
BN-1825	1"	(25MM APPROX.)
BN-1830	1-3/16"	(29MM APPROX.)
BN-1832	1-1/4"	(30MM APPROX.)
BN-1838	1-1/2"	(36MM APPROX.)
BN-1840	1-9/16"	(38MM APPROX.)
BN-1845	1-3/4"	(42MM APPROX.)
BN-1850	2"	(50MM APPROX.)

SAFETY INSTRUCTIONS

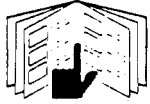

- Read and understand this manual and all the safety instructions before operating this nailer. If you have any questions, please contact our authorized service centres or retailers for help.



- Never allow the use of flammable gases as a power source for the nailer. Use filtered, lubricated and regulated compressed air only.



- Never use gasoline or other flammable liquids to clean this nailer. Vapors in the nailer will ignite by a spark and cause the nailer to explode.



- Do not exceed the maximum permissible operating pressure of this nailer (120 PSI).

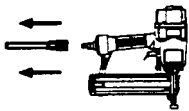

- Disconnect the nailer from its air supply before clearing jams, servicing, adjusting and while the nailer is not in use.



- Do not keep the trigger pulled when carrying or holding the nailer. Never carry the nailer by the air hose or pull on the air hose to move the nailer.



- At the workplace, always wear protective equipment such as Z87 safety glasses, hearing and head protection.

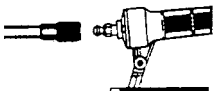

- Do not use a check valve or any other fitting which allows air to remain in the nailer.



- Do not place your hand or any part of your body in the nail discharge area of the nailer when connecting or disconnecting from the air supply.



- Never point any operational nail driving tool at yourself or at any other person.



LUBRICATION AIR SUPPLY AND CONNECTIONS

LUBRICATION AND MAINTENANCE



- Your nailer needs to be lubricated before and after the first time you use it.

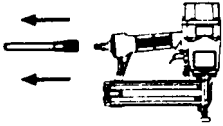

- Disconnect the air supply from the nailer before lubricating.

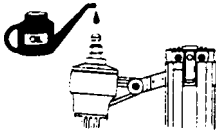

- Turn the nailer so that the inlet is facing up and put **ONE DROP** of high speed spindle oil or oil without detergent into the air inlet. Never use detergent oil or additives. Operate the nailer briefly after adding oil.

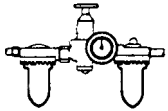

- Wipe off excessive oil at the exhaust. Excessive oil will damage O-rings of the nailer. If an in-line oiler is used, manual lubrication through the air inlet is not required on a daily basis.

AIR SUPPLY AND CONNECTIONS WARNING!

THE FOLLOWING ILLUSTRATION SHOWS THE CORRECT MODE OF CONNECTION TO THE AIR SUPPLY SYSTEM WHICH WILL INCREASE THE EFFICIENCY AND USEFUL LIFE OF THE NAILER.

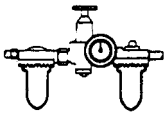
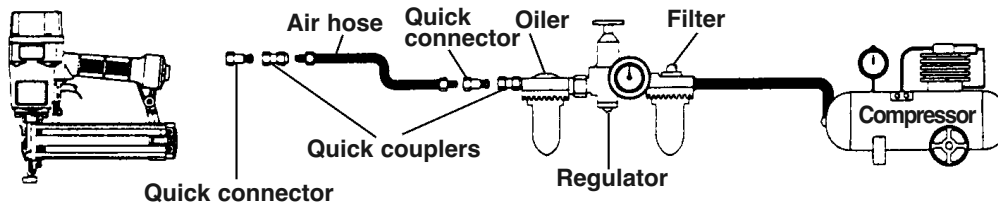

- Many air tool users find it convenient to use an oiler to help provide oil circulation through the tool as it increases the efficiency and useful life of the tool. Check oil level in the oiler daily.

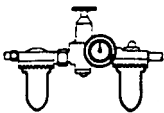

- Many air tool users find it convenient to use a filter to remove moisture and impurities which can rust or wear internal parts of the tool. A filter also increases the efficiency and useful life of the tool. The filter must be checked on a daily basis and, if necessary, drained.

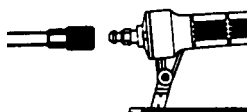

- For better performance, install a 3/8" quick connector (1/4" NPT threads) with an inside diameter of .315" (8mm) on your tool and a 3/8" quick coupler on the air hose.

FIRING MODE & VERIFICATION



Sequential Mode

In sequential mode, the nailer is actuated by depressing the nailer nose against the work surface, the trigger then needs to be pulled and released each time a nail is driven.



OPERATING A CONTACT SAFETY TRIP NAILER (SEQUENTIAL MODE):

- The operator is required to have the finger off the trigger and the nose of the nailer to be placed on the workpiece.

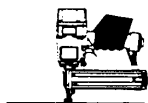

- The contact safety trip mechanism is then depressed against the workpiece and the trigger is pulled to drive the nail.

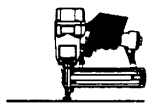

- The trigger is released after each nail is driven.
- Move the nailer to the next location and repeat the above procedure.

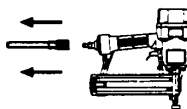

VERIFICATION

- Disconnect the air supply from the air inlet.

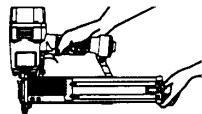

- Empty all nails from the magazine.

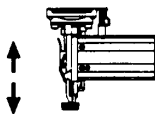

- Make sure the trigger and the contact safety trip mechanism (nose) moves up and down without sticking.

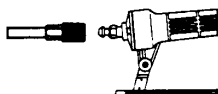

- Connect the air supply to the nailer air inlet.



- Depress the contact safety trip mechanism against the workpiece without pulling the trigger. The nailer must not cycle. **Never use the tool if a cycle occurs.**



- Hold the nailer clear of the workpiece. The contact safety trip mechanism should return to its original down position. Pull the trigger. The tool must not cycle. **Never use the nailer if a cycle occurs.**

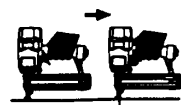

- Depress the contact safety trip mechanism against the workpiece and pull the trigger, the nailer must cycle.



LOADING NAILER & CLEARING JAMS

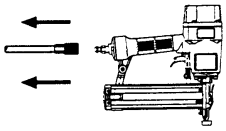

LOADING NAILER MAGAZINE

- Disconnect the air hose from the nailer air inlet.

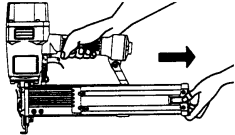

- Depress the magazine latch, pull back on the magazine cover.

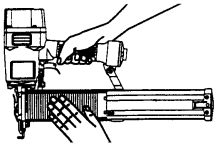

- Insert a stick of nails into the magazine. Make sure the pointed ends of the nails are as close to the bottom edge of the magazine as possible, ensuring the head of the nail is aligned with the appropriate machined groove in the magazine.

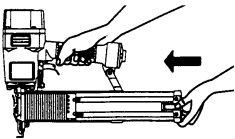

- Push the magazine cover forward until the latch catches.

CLEARING JAMS

Disconnect the nailer from the air compressor before adjusting, clearing jams, servicing, relocating and during non-operation.

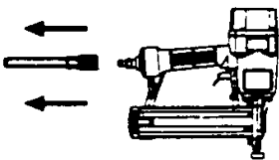

- Disconnect the air hose from the nailer air inlet.

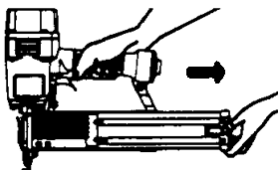

- Depress the magazine latch, pull back on the magazine cover and remove all nails.

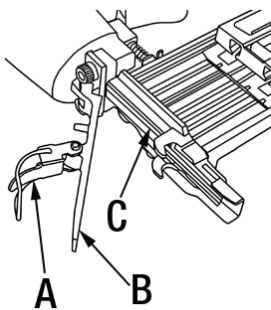

- Undo the quick release latch (A) and lift the front plate (B) as shown. Using pliers, remove the jammed nail from nail discharge area (C). Once the jammed nail is removed, lower front plate and secure it in place using the quick release latch.

OPERATING YOUR NAILER



OPERATING YOUR NAILER



WARNING! Protect your eyes and ears. Wear Z87 safety glasses with side shields. Wear hearing protection. Employers are responsible for ensuring the user or anyone near the nailer wears the above mentioned safety protection.



WARNING! Check and replace any damaged or worn components.

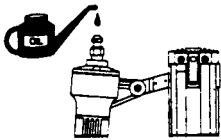

- Add one/two drops of high speed oil (non detergent) for air tools into the air inlet.

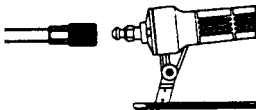

- Install a quick connect fitting to the nailer.

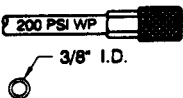

- Connect the nailer to an air compressor using a 3/8" I.D. hose. Make sure the magazine does not contain any nails and that the air hose has a rated working pressure exceeding 200 PSI and a female quick coupler.



- Regulate the air pressure to obtain 85 PSI. Check the operation of the contact safety trip mechanism following the instructions in this manual.

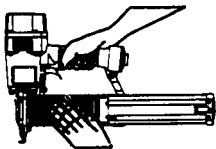

- Load magazine with nails following the instructions in this manual.

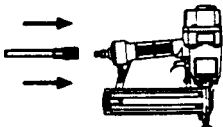

- Reconnect the air hose to the nailer air inlet.



- Test for proper nail penetration by driving nails into scrap wood. If the nails do not achieve the desired penetration, regulate the air pressure to a higher setting until the desired penetration is achieved. Do not exceed 120 PSI (Operating pressure 60-100 PSI).



MAINTENANCE & TROUBLESHOOTING



CLEANING YOUR NAILER

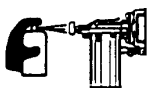
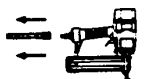

- Never use gasoline or other flammable liquids to clean the nailer. Vapors in the nailer will ignite by a spark and cause the tool to explode and result in death or serious personal injury.
- Disconnect the air supply from the nailer.
- Remove tar buildup with #2 kerosene fuel oil or diesel fuel. Do not allow solvent to get into the cylinder or damage may occur. Dry off the tool completely before use.

TROUBLESHOOTING CHART

WARNING: Stop using this tool immediately if any of the following problems occur. Serious personal injury could occur. Any repairs or replacements must be done by a qualified person or an authorized service centre only.

Problem	Cause	Solution
• Air leaking at trigger valve area.	• O-rings in trigger valve are damaged.	• O-rings must be replaced and safety trip mechanism must be verified.
• Air leaking between housing and nose.	• Loose screws in housing. • Damaged O-rings. • Bumper damage.	• Screws need to be tightened. • O-rings must be replaced. • Bumper needs to be replaced.
• Air leaking between housing and cap assembly.	• Loose screws. • Damaged seal.	• Screws need to be tightened. • Seal must be replaced.
• Nailer skips a nail.	• Worn bumper. • Dirt in nailer nose. • Dirt or damage prevents nails from moving freely in the magazine. • Inadequate air flow to nailer. • Worn O-ring on piston or lack of lubrication. • Damaged O-rings on trigger valve. • Air leaks. • Cap seal is leaking.	• Bumper needs to be replaced. • Clean. • Magazine must be cleaned. • Hose fitting and air compressor need to be checked. • O-rings must be replaced, lubricate. • O-rings must be replaced. • Screws and fittings need to be tightened. • Seal needs to be replaced.
• Nailer runs too slowly or has loss of power.	• Nailer is not sufficiently lubricated. • Broken spring in cap assembly. • Exhaust port in cap is blocked.	• Lubricate. • Spring needs to be replaced. • Damaged internal parts must be replaced.
• Jammed nails.	• Driver guide worn or damaged. • Nails are bent. • Magazine or nose screws are loose. • Damaged driver.	• Replace driver guide. • Replace with undamaged nails. • Screws need to be tightened. • Replace driver.

REPLACEMENT DRIVER, BUMPER & O-RING REPAIR KITS

After prolonged use of your Nailer, the internal driver, bumper and o-rings may have to be replaced caused by wear & tear. To repair, a complete Driver, Bumper & O-ring Replacement Accessory Kit is available for your Nailer (model: KW-169). Contact your local King Canada distributor for more information.



KW-169