

**SLIMLINE**  
COLLECTION  
Design • Evolution

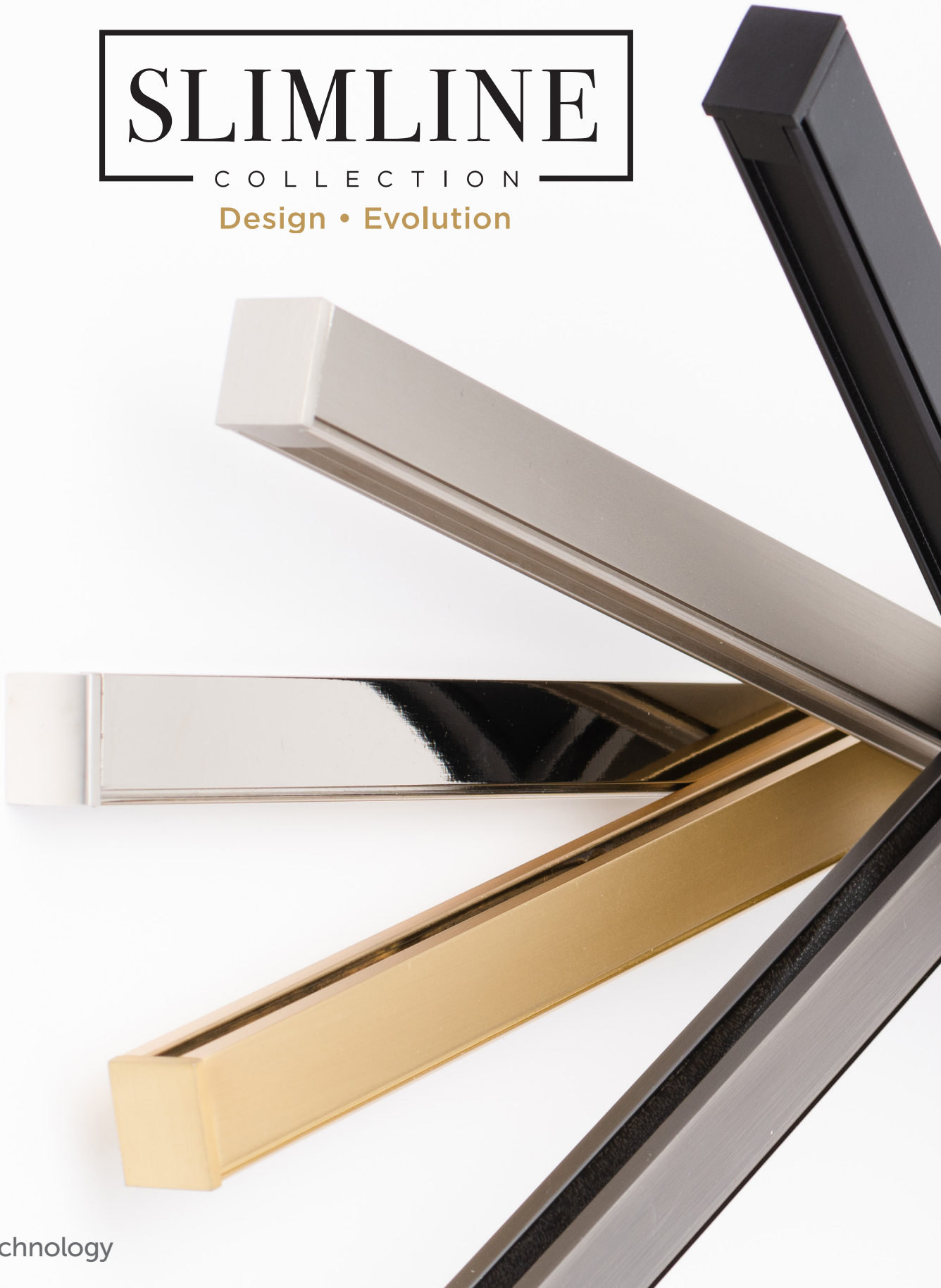



# Endless Possibilities



TCHIP

# Design Evolution

Trax Drapery Hardware was founded on the principle that innovation, design and quality do not need to be sacrificed to provide exceptional value. Offering a wide range of in-stock and ready to ship hardware, Trax Drapery Hardware has evolved and developed an extensive range of exclusive products, designs and colors. The Slim Line Collection is a follow-up to Trax' Iconic Collection, featuring new patent-pending SmartSet™ Technology, continuing this tradition of innovation by simplifying the installation process while respecting the customer's expectations of design and value.

The Slim Line Collection is the latest addition to the Trax Drapery Hardware range of products. The collection offers five designer colors. From

modern to elegant, every curve has been designed to enhance any room decor. Every color has been carefully selected, from Polished Nickel to Matte Black and Brushed Brass combinations, the design possibilities are endless.

Offering the widest range of components and accessories, the Slim Line Collection has been engineered for installation precision. Trax's new patent-pending SmartSet™ Technology offers easy to install channel rods.

We hope that the Slim Line Collection will meet our discerning customer's design needs and continue in our never-ending goal of achieving design evolution.



**Note:** Sizes are approximate.  
Pictures of products may not be exact color.



# Slim Line Channel Rods

Rod Dimension 0.65" x 0.80"



# Slim Line Channel Rod Joint

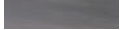

TSR4 AP  
TSR6 AP  
TSR8 AP  
TSR10 AP \*

Color:   
Antique Pewter: AP  
Sold Individually

TSJNT AP



Sold Individually



TSR4 BB  
TSR6 BB  
TSR8 BB  
TSR10 BB \*

Color:   
Brushed Brass: BB  
Sold Individually

TSJNT BB



Sold Individually



TSR4 MB  
TSR6 MB  
TSR8 MB  
TSR10 MB \*

Color:   
Matte Black: MB  
Sold Individually

TSJNT MB



Sold Individually



TSR4 PN  
TSR6 PN  
TSR8 PN  
TSR10 PN \*

Color:   
Polished Nickel: PN  
Sold Individually

TSJNT PN



Sold Individually

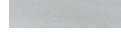

TSR4 SN  
TSR6 SN  
TSR8 SN  
TSR10 SN \*

Color:   
Satin Nickel: SN  
Sold Individually

TSJNT SN



Sold Individually

TSR4 Length 4' | TSR6 Length 6' | TSR8 Length 8' | TSR10 Length 10'

# Slimline Single Bracket

Rod Compatibility



# Slimline Single Bracket with Cover

TLS AP

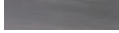

Color:   
 Antique Pewter: AP  
 Sold Individually

TLSV AP

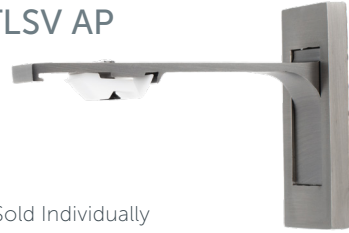

Sold Individually

TLS BB



Color:   
 Brushed Brass: BB  
 Sold Individually

TLSV BB

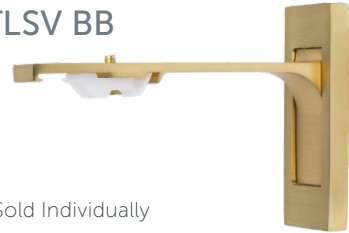

Sold Individually

TLS MB



Color:   
 Matte Black: MB  
 Sold Individually

TLSV MB



Sold Individually

TLS PN



Color:   
 Polished Nickel: PN  
 Sold Individually

TLSV PN

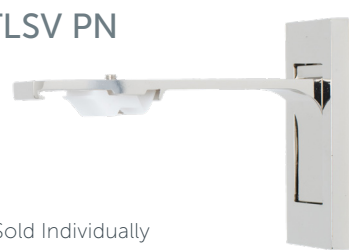

Sold Individually

TLS SN



Color:   
 Satin Nickel: SN  
 Sold Individually

TLSV SN



Sold Individually

## Dimensions

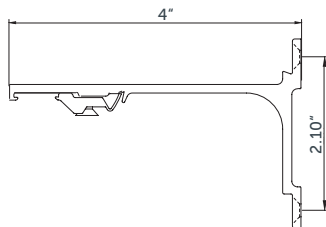
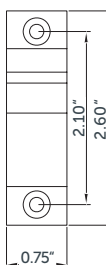

## Cover

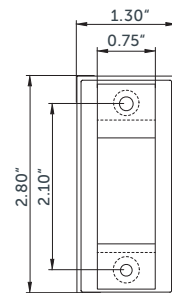

# Slimline 6 1/2" Bracket

Rod Compatibility 

# Slimline 6 1/2" Bracket with Cover

TLL AP



Color:   
 Antique Pewter: AP  
 Sold Individually

TLLV AP



Sold Individually

TLL BB



Color:   
 Brushed Brass: BB  
 Sold Individually

TLLV BB



Sold Individually

TLL MB



Color:   
 Matte Black: MB  
 Sold Individually

TLLV MB



Sold Individually

TLL PN



Color:   
 Polished Nickel: PN  
 Sold Individually

TLLV PN



Sold Individually

TLL SN



Color:   
 Satin Nickel: SN  
 Sold Individually

TLLV SN



Sold Individually

Dimensions

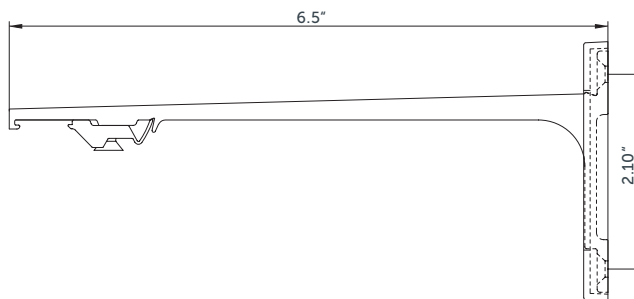
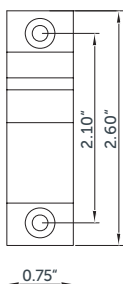

Cover

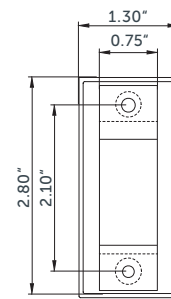

# Slimline Double Bracket

Rod Compatibility



# Slimline Double Bracket with Cover

TLD AP

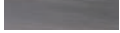

Color:   
 Antique Pewter: AP  
 Sold Individually

TLDV AP



Sold Individually

TLD BB



Color:   
 Brushed Brass: BB  
 Sold Individually

TLDV BB



Sold Individually

TLD MB



Color:   
 Matte Black: MB  
 Sold Individually

TLDV MB



Sold Individually

TLD PN



Color:   
 Polished Nickel: PN  
 Sold Individually

TLDV PN



Sold Individually

TLD SN



Color:   
 Satin Nickel: SN  
 Sold Individually

TLDV SN



Sold Individually

## Dimensions

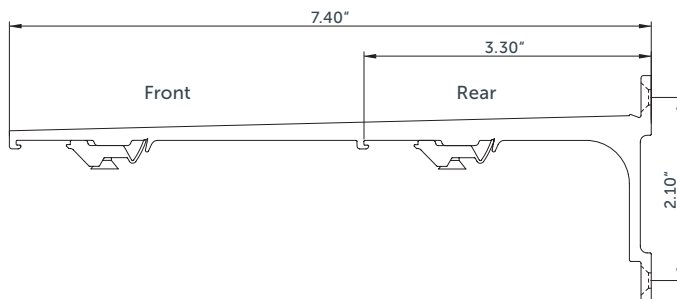
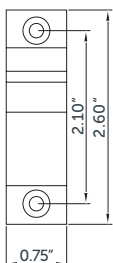

## Cover

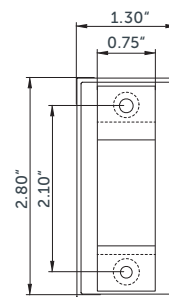

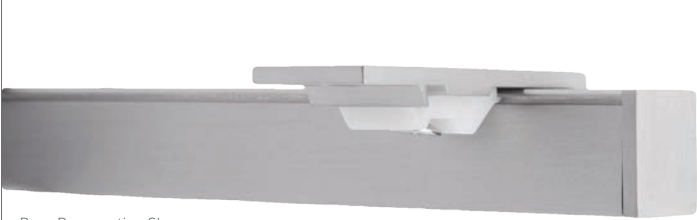

Rear Perspective Shown

### Slim Line Endcaps

### Slim Line Ceiling Mount



#### TSEC AP



Sold in Pairs

#### TSM AP



Color:   
Antique Pewter: AP  
Sold Individually

#### TSEC BB



Sold in Pairs

#### TSM BB



Color:   
Brushed Brass: BB  
Sold Individually

#### TSEC MB



Sold in Pairs

#### TSM MB



Color:   
Matte Black: MB  
Sold Individually

#### TSEC PN



Sold in Pairs

#### TSM PN



Color:   
Polished Nickel: PN  
Sold Individually

#### TSEC SN



Sold in Pairs

#### TSM SN



Color:   
Satin Nickel: SN  
Sold Individually



# Channel Rod Components

Rod Compatibility 



**SM8L** (Left Master Underlap)

Sold Individually



**SM8R** (Right Master Overlap)

Sold Individually

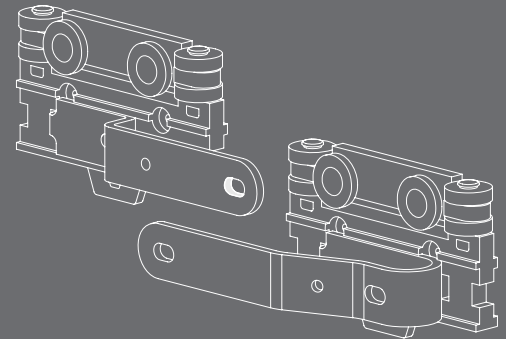

# Ball Bearing Carriers

Reengineered, SmartSet™ ball bearing carriers offer the smoothest and quietest movement on the market today

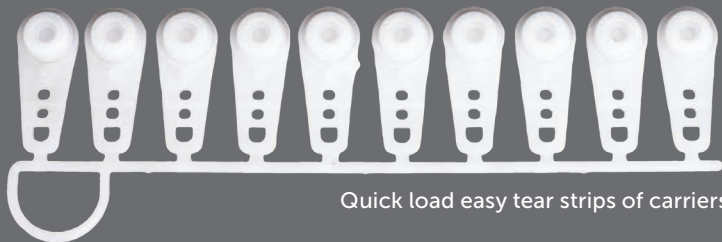

Quick load easy tear strips of carriers

**SC16**

Sold in Strips of 10

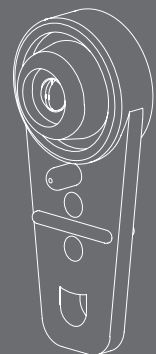

# RPL-TECH® Carrier Guide

Carrier guide shows the maximum number of carriers required per track length.

| Track Length in Inches | Fullness    |                  |             |                  |              |                   |              |                   |
|------------------------|-------------|------------------|-------------|------------------|--------------|-------------------|--------------|-------------------|
|                        | 60% One Way | 60% Center Split | 80% One Way | 80% Center Split | 100% One Way | 100% Center Split | 120% One Way | 120% Center Split |
| 24-30                  | 12          | 12               | 13          | 14               | 15           | 16                | 16           | 16                |
| 31-36                  | 14          | 14               | 16          | 16               | 17           | 18                | 20           | 20                |
| 37-42                  | 16          | 16               | 18          | 18               | 20           | 20                | 23           | 24                |
| 43-48                  | 19          | 20               | 21          | 22               | 23           | 24                | 26           | 26                |
| 49-54                  | 21          | 22               | 23          | 24               | 26           | 26                | 29           | 30                |
| 55-60                  | 23          | 24               | 26          | 26               | 29           | 30                | 32           | 32                |
| 61-66                  | 26          | 26               | 28          | 28               | 32           | 32                | 36           | 36                |
| 67-72                  | 28          | 28               | 31          | 32               | 34           | 34                | 39           | 40                |
| 73-78                  | 30          | 30               | 33          | 34               | 37           | 38                | 42           | 42                |
| 79-84                  | 32          | 32               | 36          | 36               | 40           | 40                | 45           | 46                |
| 85-90                  | 35          | 36               | 38          | 38               | 43           | 44                | 48           | 48                |
| 91-96                  | 37          | 38               | 41          | 42               | 46           | 46                | 52           | 52                |
| 97-102                 | 39          | 40               | 43          | 44               | 48           | 48                | 55           | 56                |
| 103-108                | 42          | 42               | 46          | 46               | 51           | 51                | 58           | 58                |
| 109-114                | 44          | 44               | 48          | 48               | 54           | 54                | 61           | 62                |
| 115-120                | 46          | 46               | 51          | 52               | 57           | 58                | 64           | 64                |
| 121-126                | 48          | 48               | 54          | 54               | 60           | 60                | 68           | 68                |
| 127-132                | 51          | 52               | 56          | 56               | 63           | 64                | 71           | 72                |
| 133-138                | 53          | 54               | 59          | 60               | 65           | 66                | 74           | 74                |
| 139-144                | 55          | 56               | 61          | 62               | 68           | 68                | 77           | 78                |

Carrier Quantities

RPL-Tech® Calculator Available Online

## RPL-Tech® Tape



XTP-WH

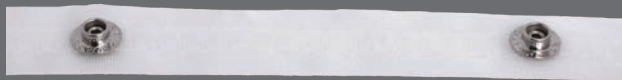

XTP-CL



XTP-BL

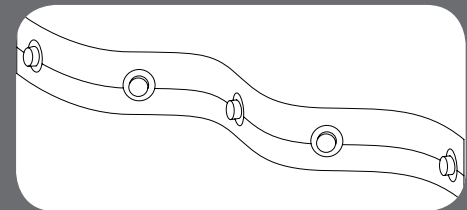









Sold by the yard or rolls of 100 yards.

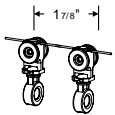
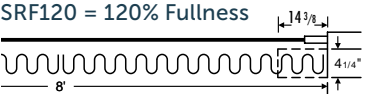

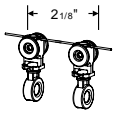
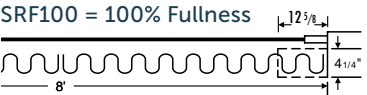
End Stop  
XES  
Sold as set

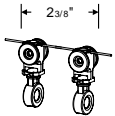
# Wheeled RPL-Tech® Carrier

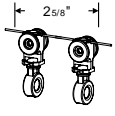
Rod Compatibility 

|                                                                                   |                                                                                                                    |                                                                                   |
|-----------------------------------------------------------------------------------|--------------------------------------------------------------------------------------------------------------------|-----------------------------------------------------------------------------------|
|  | <b>SRF120 = 120% Fullness</b><br> |  |
|  | <b>SRF100 = 100% Fullness</b><br> |  |
|  | <b>SRF80 = 80% Fullness</b><br>   |  |
|  | <b>SRF60 = 60% Fullness</b><br>   |  |



Sold in Strips of 20 Carriers

Only RPL-Tech® Carriers work with SmartSet™ Channel Rods

Quick load strips

# Glide RPL-Tech® Carrier

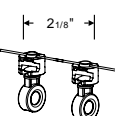
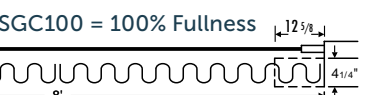
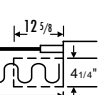
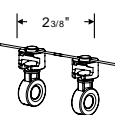
Rod Compatibility 

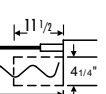
|                                                                                     |                                                                                                                    |                                                                                     |
|-------------------------------------------------------------------------------------|--------------------------------------------------------------------------------------------------------------------|-------------------------------------------------------------------------------------|
|    | <b>SGC100 = 100% Fullness</b><br> |    |
|  | <b>SGC80 = 80% Fullness</b><br> |  |

Sold in Strips of 20 Carriers

Only RPL-Tech® Carriers work with SmartSet™ Channel Rods

Quick load strips

Rod Compatibility 

## XBML (Left Touch Master)



Sold Individually

## XBMR (Right Touch Master)



Sold Individually

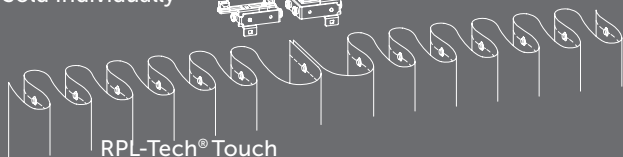

RPL-Tech® Touch

Rod Compatibility 

## SMS6L (Left Master Carrier Underlap)

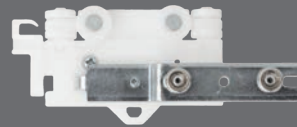

Sold Individually

## SMS6R (Right Master Carrier Overlap)

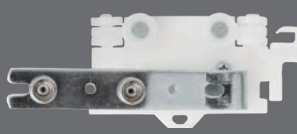

Sold Individually



RPL-Tech® Overlap

**SLIMLINE**

COLLECTION

Design • Evolution

Distributed by:

**Unique Fine Fabrics Inc.**

490 Rowntree Dairy Rd,  
Woodbridge, Ontario  
L4L 8H2

Tel: 905-851-8866 | Fax: 905-851-8846  
Toll Free: 1-800-653-0783 | Toll Free Fax: 1-877-388-5252

email: [sales@uniquefinefabrics.com](mailto:sales@uniquefinefabrics.com) | [uniquefinefabrics.com](http://uniquefinefabrics.com)