

ICONIC

COLLECTION

Design • Evolution

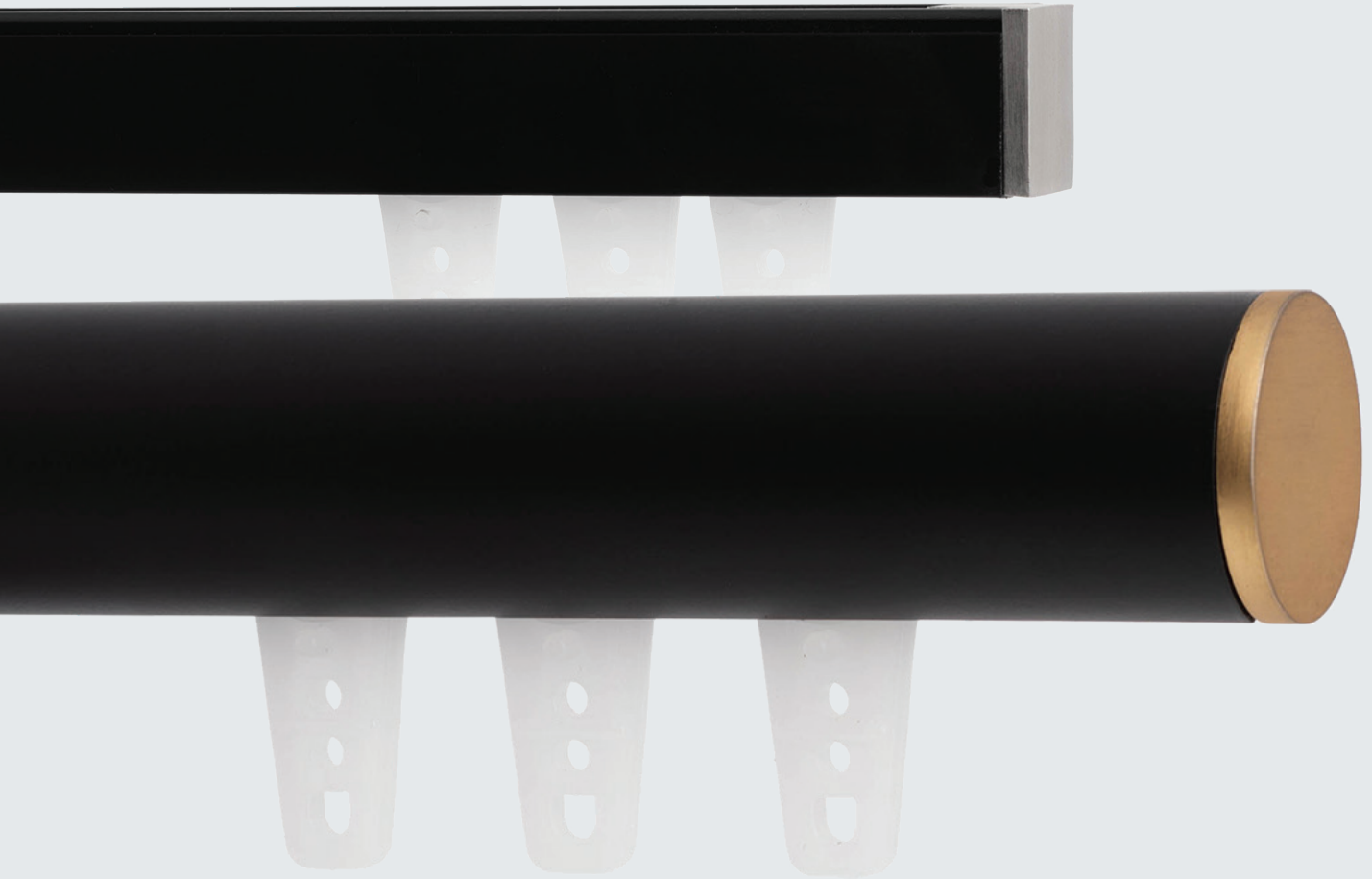



Endless Possibilities



TCHIP

Design Evolution

Trax Drapery Hardware™ was founded on the principle that innovation, design and quality do not need to be sacrificed to provide exceptional value. Offering a wide range of in-stock and ready to ship hardware, Trax Drapery Hardware™ has evolved and developed an extensive range of exclusive products, designs and colors. The Iconic Collection's new patent pending SmartSet™ Technology continues this tradition of innovation by simplifying the installation process while respecting the customer's expectations of design and value.

The Iconic Collection is the latest addition to the Trax Drapery Hardware™ range of products. The collection offers nine sensational finial designs in five designer colors. From modern to elegant, every curve has been designed to enhance any room's decor.

Every color has been carefully selected, from Polished Nickel to Matte Black and Brushed Brass combinations, the design possibilities are endless.

Offering the widest range of components and accessories, the Iconic Collection has been engineered for installation precision. Trax's new patent pending SmartSet™ Technology offers easy to install channel rods and the world's first post-installation vertical adjustments on channel rods. SmartSet™ Technology offers up to half an inch in post-installation vertical adjustment, providing the highest level of precision and customer satisfaction.

We hope that the Iconic Collection will meet our discerning customer's design needs and continue in our never-ending goal of achieving design evolution.



Note: Sizes are approximate. Pictures of products may not be exact color.

Finials

Rod Compatibility  

TFN1 AP

Color: 
 Antique Pewter: AP
 Sold in Sets (Right and Left)



TFN1 BB

Color: 
 Brushed Brass: BB
 Sold in Sets (Right and Left)



TFN1 MB

Color: 
 Matte Black: MB
 Sold in Sets (Right and Left)



TFN1 PN

Color: 
 Polished Nickel: PN
 Sold in Sets (Right and Left)



TFN1 SN

Color: 
 Satin Nickel: SN
 Sold in Sets (Right and Left)



Dimensions

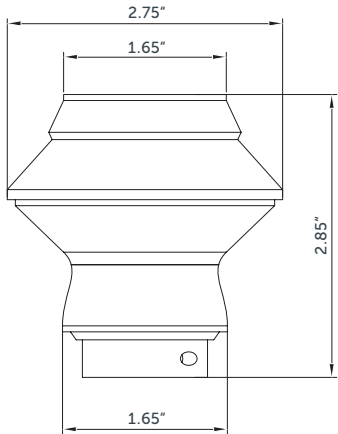

Finials

Rod Compatibility



TFN2 AP



Color: 
Antique Pewter: AP
Sold in Pairs

TFN2 BB



Color: 
Brushed Brass: BB
Sold in Pairs

TFN2 MB

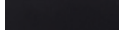

Color: 
Matte Black: MB
Sold in Pairs

TFN2 PN



Color: 
Polished Nickel: PN
Sold in Pairs

TFN2 SN



Color: 
Satin Nickel: SN
Sold in Pairs

Dimensions

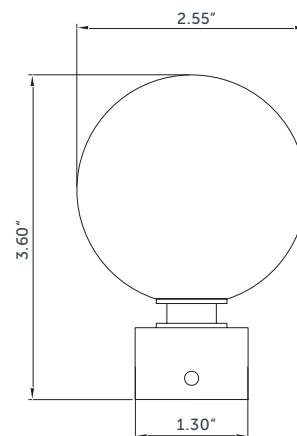

Finials

Rod Compatibility  

TFN3 AP



Color: 
Antique Pewter: AP
Sold in Pairs

TFN3 BB



Color: 
Brushed Brass: BB
Sold in Pairs

TFN3 MB

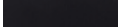

Color: 
Matte Black: MB
Sold in Pairs

TFN3 PN



Color: 
Polished Nickel: PN
Sold in Pairs

TFN3 SN

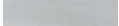

Color: 
Satin Nickel: SN
Sold in Pairs

Dimensions

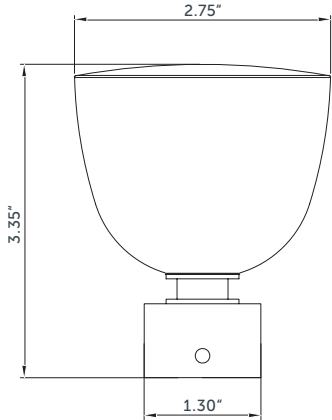

Finials

Rod Compatibility  

TFN4 AP



Color: 
Antique Pewter: AP
Sold in Pairs

TFN4 BB



Color: 
Brushed Brass: BB
Sold in Pairs

TFN4 MB



Color: 
Matte Black: MB
Sold in Pairs

TFN4 PN



Color: 
Polished Nickel: PN
Sold in Pairs

TFN4 SN



Color: 
Satin Nickel: SN
Sold in Pairs

Dimensions

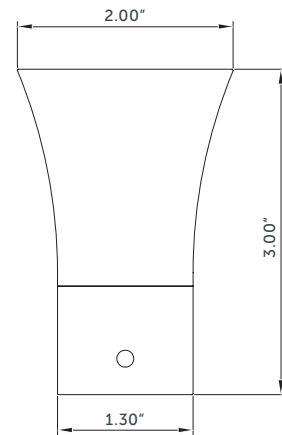

Finials

Rod Compatibility  

TFN5 AP



Color: 
 Antique Pewter: AP
 Sold in Pairs

TFN5 BB



Color: 
 Brushed Brass: BB
 Sold in Pairs

TFN5 MB



Color: 
 Matte Black: MB
 Sold in Pairs

TFN5 PN



Color: 
 Polished Nickel: PN
 Sold in Pairs

TFN5 SN



Color: 
 Satin Nickel: SN
 Sold in Pairs

Dimensions

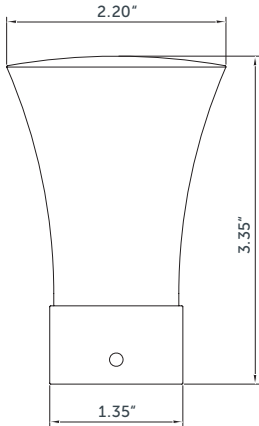

Finials

Rod Compatibility  

TFN6 AP



Color: 
Antique Pewter: AP
Sold in Pairs

TFN6 BB



Color: 
Brushed Brass: BB
Sold in Pairs

TFN6 MB



Color: 
Matte Black: MB
Sold in Pairs

TFN6 PN



Color: 
Polished Nickel: PN
Sold in Pairs

TFN6 SN



Color: 
Satin Nickel: SN
Sold in Pairs

Dimensions

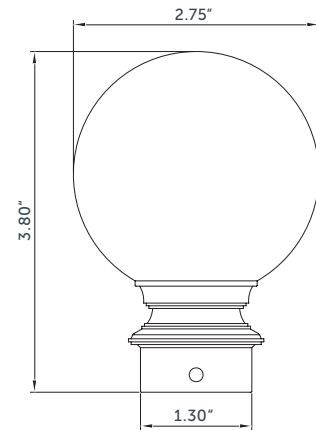

Finials

Rod Compatibility  

TFN7 AP



Color: 
 Antique Pewter: AP
 Sold in Pairs

TFN7 BB



Color: 
 Brushed Brass: BB
 Sold in Pairs

TFN7 MB



Color: 
 Matte Black: MB
 Sold in Pairs

TFN7 PN



Color: 
 Polished Nickel: PN
 Sold in Pairs

TFN7 SN



Color: 
 Satin Nickel: SN
 Sold in Pairs

Dimensions

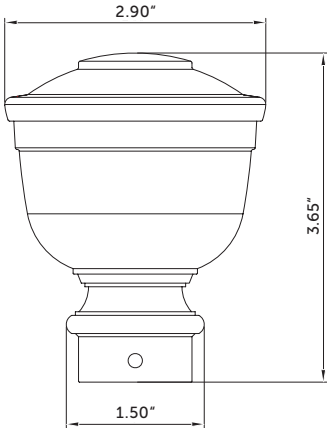

Finials

Rod Compatibility  

TFN8 AP



Color: 
 Antique Pewter: AP
 Sold in Sets (Right and Left)

TFN8 BB



Color: 
 Brushed Brass: BB
 Sold in Sets (Right and Left)

TFN8 MB



Color: 
 Matte Black: MB
 Sold in Sets (Right and Left)

TFN8 PN



Color: 
 Polished Nickel: PN
 Sold in Sets (Right and Left)

TFN8 SN



Color: 
 Satin Nickel: SN
 Sold in Sets (Right and Left)

Dimensions

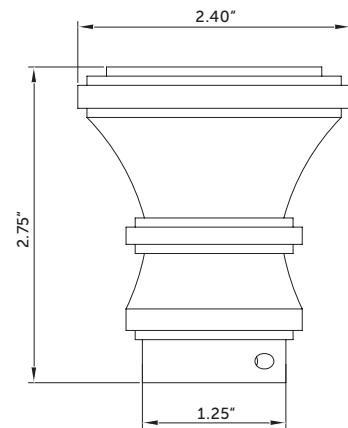

Finials

Rod Compatibility  

TFN9 AP



Color: 
 Antique Pewter: AP
 Sold in Pairs

TFN9 BB



Color: 
 Brushed Brass: BB
 Sold in Pairs

TFN9 MB



Color: 
 Matte Black: MB
 Sold in Pairs

TFN9 PN



Color: 
 Polished Nickel: PN
 Sold in Pairs

TFN9 SN



Color: 
 Satin Nickel: SN
 Sold in Pairs

Dimensions

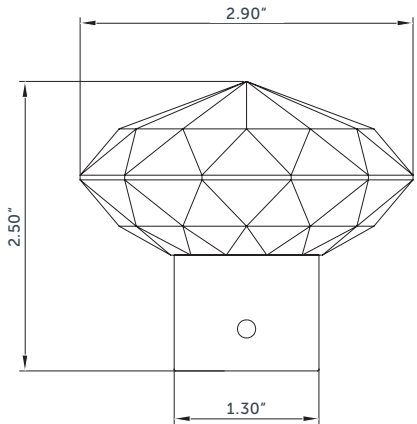

End Caps

Rod Compatibility  

TEC AP

Color: 
 Antique Pewter: AP
 Sold in Pairs



TEC BB

Color: 
 Brushed Brass: BB
 Sold in Pairs

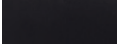

TEC MB

Color: 
 Matte Black: MB
 Sold in Pairs



TEC PN

Color: 
 Polished Nickel: PN
 Sold in Pairs



TEC SN

Color: 
 Satin Nickel: SN
 Sold in Pairs



Dimensions

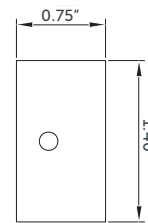

Wall Mounts

Rod Compatibility  

TWM AP

Color: 
 Antique Pewter: AP
 Sold in Pairs*



TWM BB

Color: 
 Brushed Brass: BB
 Sold in Pairs*



TWM MB

Color: 
 Matte Black: MB
 Sold in Pairs*



TWM PN

Color: 
 Polished Nickel: PN
 Sold in Pairs*



TWM SN

Color: 
 Satin Nickel: SN
 Sold in Pairs*



Dimensions

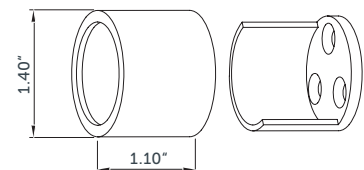

*Pairs consist of 2 wall mounts and 2 covers

Single Bracket

Rod Compatibility



TBK AP

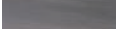

Color: 
 Antique Pewter: AP
 Sold Individually

TBK BB



Color: 
 Brushed Brass: BB
 Sold Individually

TBK MB



Color: 
 Matte Black: MB
 Sold Individually

TBK PN

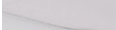

Color: 
 Polished Nickel: PN
 Sold Individually

TBK SN



Color: 
 Satin Nickel: SN
 Sold Individually

Dimensions

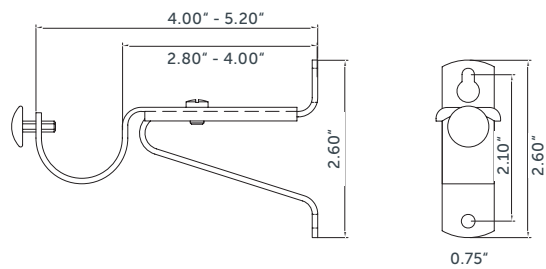

Double Bracket

Rod Compatibility



TDBK AP

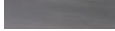

Color: 
 Antique Pewter: AP
 Sold Individually

TDBK BB



Color: 
 Brushed Brass: BB
 Sold Individually

TDBK MB



Color: 
 Matte Black: MB
 Sold Individually

TDBK PN



Color: 
 Polished Nickel: PN
 Sold Individually

TDBK SN

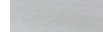

Color: 
 Satin Nickel: SN
 Sold Individually

Dimensions

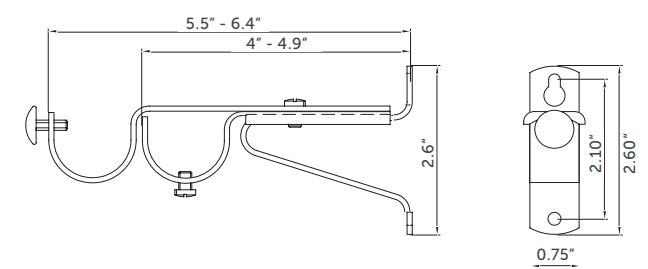

Ceiling Bracket

Rod Compatibility 

TCB AP

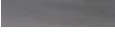

Color: 
Antique Pewter: AP
Sold Individually

TCB BB



Color: 
Brushed Brass: BB
Sold Individually

TCB MB



Color: 
Matte Black: MB
Sold Individually

TCB PN



Color: 
Polished Nickel: PN
Sold Individually

TCB SN



Color: 
Satin Nickel: SN
Sold Individually

Dimensions

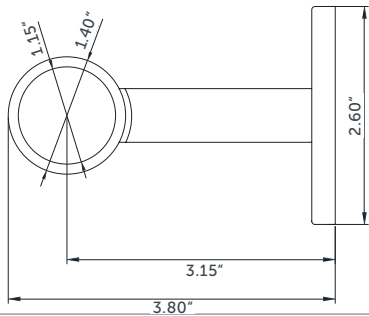

Wand

Rod Compatibility   

TWND AP

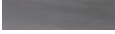

Color: 
Antique Pewter: AP
Sold Individually

TWND BB



Color: 
Brushed Brass: BB
Sold Individually

TWND MB



Color: 
Matte Black: MB
Sold Individually

TWND PN



Color: 
Polished Nickel: PN
Sold Individually

TWND SN



Color: 
Satin Nickel: SN
Sold Individually

Dimensions

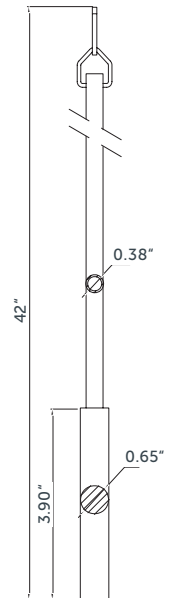

Single Bracket

Rod Compatibility



Single Bracket with Plate

TSB AP

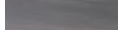

Color: 
Antique Pewter: AP
Sold Individually

TSV AP



Sold Individually

TSB BB



Color: 
Brushed Brass: BB
Sold Individually

TSV BB



Sold Individually

TSB MB



Color: 
Matte Black: MB
Sold Individually

TSV MB



Sold Individually

TSB PN



Color: 
Polished Nickel: PN
Sold Individually

TSV PN



Sold Individually

TSB SN



Color: 
Satin Nickel: SN
Sold Individually

TSV SN



Sold Individually

Dimensions

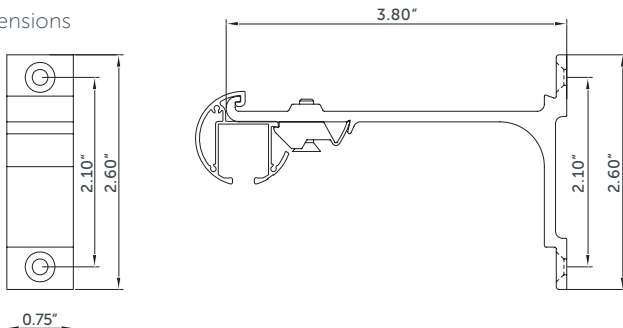

Cover

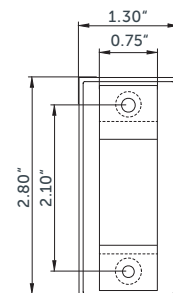

Double Bracket

Rod Assembly



Double Bracket with Plate

TDB AP

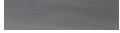

Color: 
 Antique Pewter: AP
 Sold Individually

TDV AP



Sold Individually

TDB BB



Color: 
 Brushed Brass: BB
 Sold Individually

TDV BB



Sold Individually

TDB MB



Color: 
 Matte Black: MB
 Sold Individually

TDV MB



Sold Individually

TDB PN



Color: 
 Polished Nickel: PN
 Sold Individually

TDV PN



Sold Individually

TDB SN



Color: 
 Satin Nickel: SN
 Sold Individually

TDV SN



Sold Individually

Dimensions

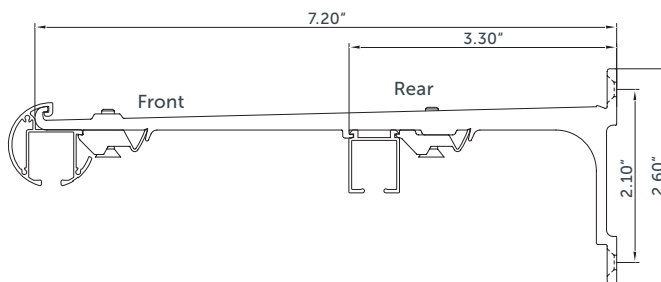
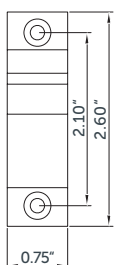

Cover

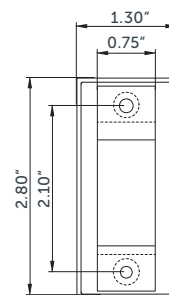

Adjustable Brackets

Featuring SmartSet™ Technology

Rod Compatibility



TAB AP



Color: 
Antique Pewter: AP
Sold Individually

TAB BB



Color: 
Brushed Brass: BB
Sold Individually

TAB MB



Color: 
Matte Black: MB
Sold Individually

TAB PN



Color: 
Polished Nickel: PN
Sold Individually

TAB SN

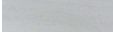

Color: 
Satin Nickel: SN
Sold Individually

Dimensions

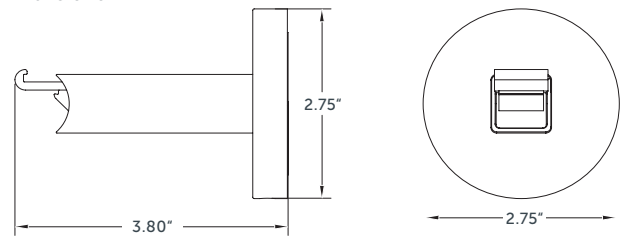

SmartSet™ Technology Overview

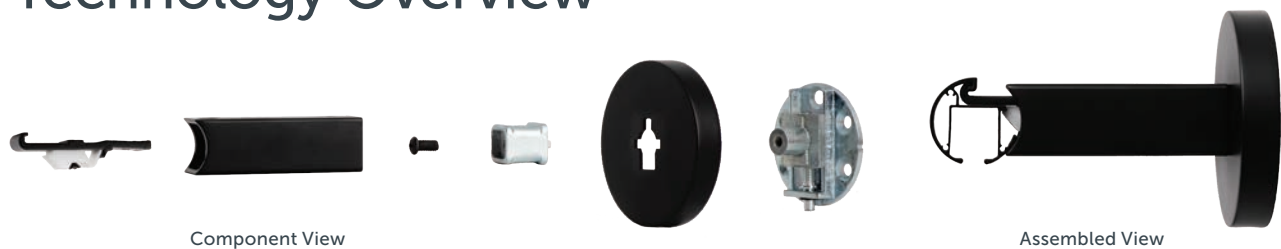

Patent Pending

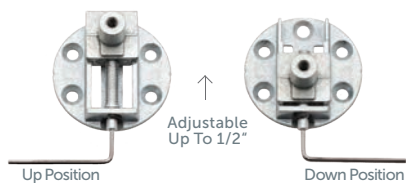

SmartSet™ Technology allows for up to half an inch in height adjustability after installation.

Channel Rods

Rod Diameter 1 1/8" 

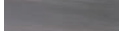

TRC4 AP
TRC6 AP
TRC8 AP
TRC10 AP *

Color: 
Antique Pewter: AP
Sold Individually



TRC4 BB
TRC6 BB
TRC8 BB
TRC10 BB *

Color: 
Brushed Brass: BB
Sold Individually



TRC4 MB
TRC6 MB
TRC8 MB
TRC10 MB *

Color: 
Matte Black: MB
Sold Individually



TRC4 PN
TRC6 PN
TRC8 PN
TRC10 PN *

Color: 
Polished Nickel: PN
Sold Individually



TRC4 SN
TRC6 SN
TRC8 SN
TRC10 SN *

Color: 
Satin Nickel: SN
Sold Individually

Channel Rod Joint Cover

TCC AP



Sold Individually

TCC BB



Sold Individually

TCC MB



Sold Individually

TCC PN



Sold Individually

TCC SN



Sold Individually

TRC4 Length 4' | TRC6 Length 6' | TRC8 Length 8' | TRC10 Length 10'

Channel Rod Joint



TCJNT

Sold Individually

* Due to certain courier restrictions, shipping of rods over 8' is not available in all territories and subject to additional shipping charges. Please contact customer service if you would like to place an order for a rod over 8'.



Slim Line Channel Rods

Rod Dimension 0.65" x 0.80"



Slim Line Channel Rod Joint

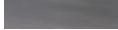

TSR4 AP
TSR6 AP
TSR8 AP
TSR10 AP *

Color: 
Antique Pewter: AP
Sold Individually

TSJNT AP



Sold Individually



TSR4 BB
TSR6 BB
TSR8 BB
TSR10 BB *

Color: 
Brushed Brass: BB
Sold Individually

TSJNT BB



Sold Individually



TSR4 MB
TSR6 MB
TSR8 MB
TSR10 MB *

Color: 
Matte Black: MB
Sold Individually

TSJNT MB



Sold Individually



TSR4 PN
TSR6 PN
TSR8 PN
TSR10 PN *

Color: 
Polished Nickel: PN
Sold Individually

TSJNT PN



Sold Individually



TSR4 SN
TSR6 SN
TSR8 SN
TSR10 SN *

Color: 
Satin Nickel: SN
Sold Individually

TSJNT SN



Sold Individually

TSR4 Length 4' | TSR6 Length 6' | TSR8 Length 8' | TSR10 Length 10'

Rods

Rod Diameter 1 1/8" 



TR4 AP
TR6 AP
TR8 AP
TR10 AP *

Color: 
Antique Pewter: AP
Sold Individually



TR4 BB
TR6 BB
TR8 BB
TR10 BB *

Color: 
Brushed Brass: BB
Sold Individually



TR4 MB
TR6 MB
TR8 MB
TR10 MB *

Color: 
Matte Black: MB
Sold Individually



TR4 PN
TR6 PN
TR8 PN
TR10 PN *

Color: 
Polished Nickel: PN
Sold Individually



TR4 SN
TR6 SN
TR8 SN
TR10 SN *

Color: 
Satin Nickel: SN
Sold Individually

Rod Joint



TJNT

Sold Individually

Flat Rings



TRGF AP
Sold in Packs of 10



TRGF BB
Sold in Packs of 10



TRGF MB
Sold in Packs of 10



TRGF PN
Sold in Packs of 10



TRGF SN
Sold in Packs of 10

Round Rings



TRG AP
Sold in Packs of 10



TRG BB
Sold in Packs of 10



TRG MB
Sold in Packs of 10



TRG PN
Sold in Packs of 10



TRG SN
Sold in Packs of 10

Dimensions

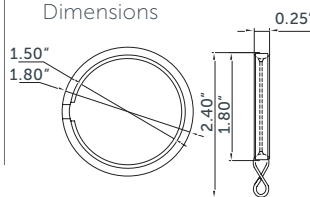

Dimensions

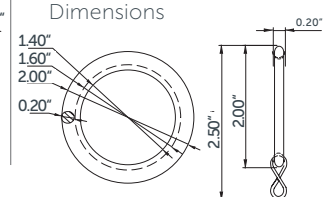

Elbows

Rod Compatibility



TEB SN
Sold Individually



TEB PN
Sold Individually



TEB MB
Sold Individually



TEB BB
Sold Individually



TEB AP
Sold Individually

TR4 Length 4' | TR6 Length 6' | TR8 Length 8' | TR10 Length 10'

* Due to certain courier restrictions, shipping of rods over 8' is not available in all territories and subject to additional shipping charges. Please contact customer service if you would like to place an order for a rod over 8'.



Rear Perspective Shown

Ceiling Flush Mount

Rod Compatibility



TFM AP



Color: 
Antique Pewter: AP
Sold Individually

TFM BB



Color: 
Brushed Brass: BB
Sold Individually

TFM MB



Color: 
Matte Black: MB
Sold Individually

TFM PN



Color: 
Polished Nickel: PN
Sold Individually

TFM SN



Color: 
Satin Nickel: SN
Sold Individually



Rear Perspective Shown

Ceiling Recessed Mount

Rod Compatibility



TCM AP



Color: 
Antique Pewter: AP
Sold Individually

TCM BB



Color: 
Brushed Brass: BB
Sold Individually

TCM MB

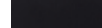

Color: 
Matte Black: MB
Sold Individually

TCM PN



Color: 
Polished Nickel: PN
Sold Individually

TCM SN

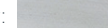

Color: 
Satin Nickel: SN
Sold Individually

End Plugs

Rod Compatibility



TPLG AP



TPLG BB



TPLG PN



TPLG MB



TPLG SN

Sold in Pairs

End Caps

Rod Compatibility



TEC AP



TEC BB



TEC PN



TEC MB



TEC SN

Sold in Pairs

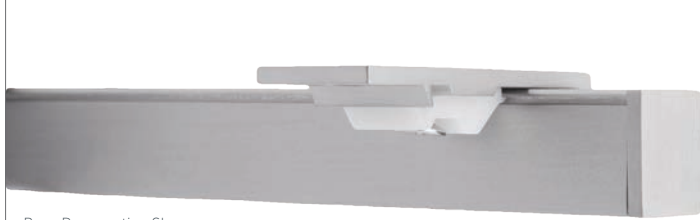

Rear Perspective Shown

Slim Line Endcaps

Slim Line Ceiling Mount

Rod Compatibility



TSEC AP



Sold in Pairs

TSM AP



Color: 
Antique Pewter: AP
Sold Individually

TSEC BB



Sold in Pairs

TSM BB



Color: 
Brushed Brass: BB
Sold Individually

TSEC MB



Sold in Pairs

TSM MB



Color: 
Matte Black: MB
Sold Individually

TSEC PN



Sold in Pairs

TSM PN



Color: 
Polished Nickel: PN
Sold Individually

TSEC SN



Sold in Pairs

TSM SN



Color: 
Satin Nickel: SN
Sold Individually

RPL-TECH® Carrier Guide

Carrier guide shows the maximum number of carriers required per track length.

Track Length in Inches	Fullness							
	60% One Way	60% Center Split	80% One Way	80% Center Split	100% One Way	100% Center Split	120% One Way	120% Center Split
24-30	12	12	13	14	15	16	16	16
31-36	14	14	16	16	17	18	20	20
37-42	16	16	18	18	20	20	23	24
43-48	19	20	21	22	23	24	26	26
49-54	21	22	23	24	26	26	29	30
55-60	23	24	26	26	29	30	32	32
61-66	26	26	28	28	32	32	36	36
67-72	28	28	31	32	34	34	39	40
73-78	30	30	33	34	37	38	42	42
79-84	32	32	36	36	40	40	45	46
85-90	35	36	38	38	43	44	48	48
91-96	37	38	41	42	46	46	52	52
97-102	39	40	43	44	48	48	55	56
103-108	42	42	46	46	51	51	58	58
109-114	44	44	48	48	54	54	61	62
115-120	46	46	51	52	57	58	64	64
121-126	48	48	54	54	60	60	68	68
127-132	51	52	56	56	63	64	71	72
133-138	53	54	59	60	65	66	74	74
139-144	55	56	61	62	68	68	77	78

Carrier Quantities

RPL-Tech® Calculator Available Online

RPL-Tech® Tape

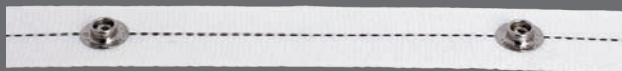

XTP-WH

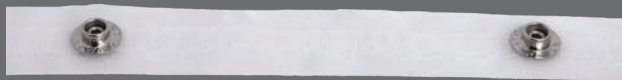

XTP-CL



XTP-BL

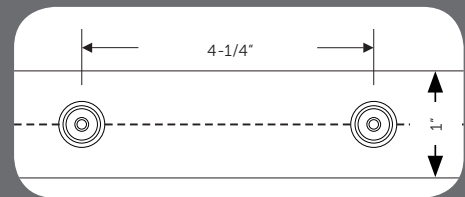
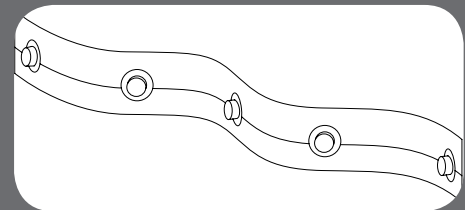





Sold by the yard or rolls of 100 yards.

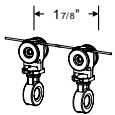
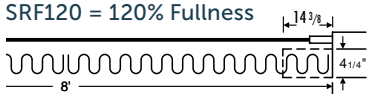
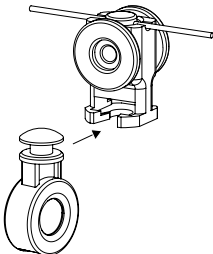
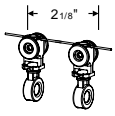

End Stop
XES
Sold as set

Wheeled RPL-Tech® Carrier

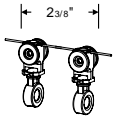
Rod Compatibility 

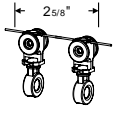
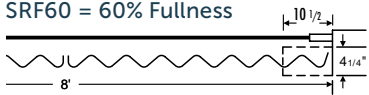
	SRF120 = 120% Fullness 	
	SRF100 = 100% Fullness 	
	SRF80 = 80% Fullness 	
	SRF60 = 60% Fullness 	



Sold in Strips of 20 Carriers

Only RPL-Tech® Carriers work with SmartSet™ Channel Rods

Quick load strips

Glide RPL-Tech® Carrier

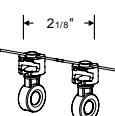
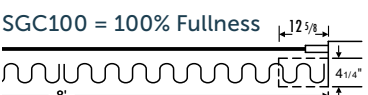
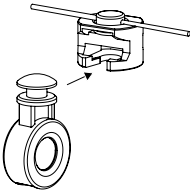
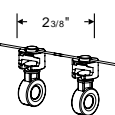
Rod Compatibility 

	SGC100 = 100% Fullness 	
	SGC80 = 80% Fullness 	

Sold in Strips of 20 Carriers

Only RPL-Tech® Carriers work with SmartSet™ Channel Rods

Quick load strips

Rod Compatibility 

XBML (Left Touch Master)



Sold Individually

XBMR (Right Touch Master)



Sold Individually

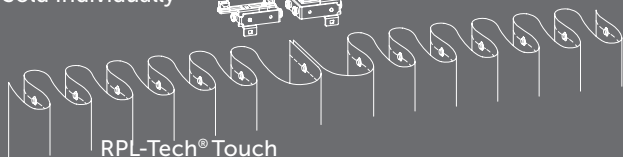

RPL-Tech® Touch

Rod Compatibility 

SMS6L (Left Master Carrier Underlap)



Sold Individually

SMS6R (Right Master Carrier Overlap)

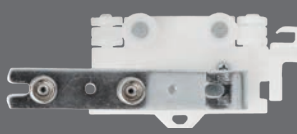

Sold Individually



RPL-Tech® Overlap



Newly re-designed and patent pending RPL-Tech® carriers are designed to be the smoothest traveling, quietest carriers on the market. The newly designed carrier pendants will make curtain hanging a snap, while quick load strips make carrier insertion quick and effortless. Only authentic RPL-Tech® carriers work with SmartSet™ channel rods.

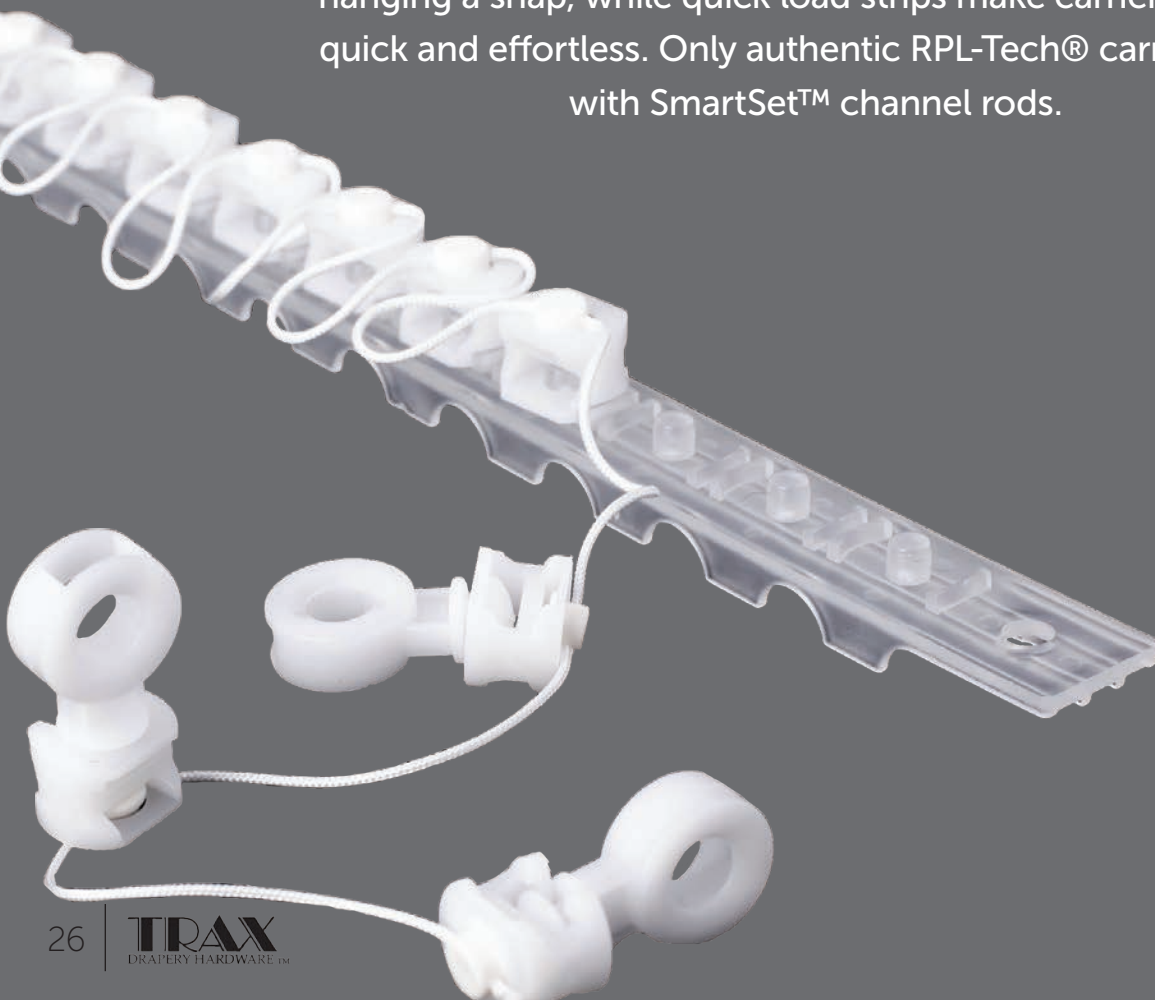

Channel Rod Components

Rod Compatibility 



SM8L (Left Master Underlap)

Sold Individually

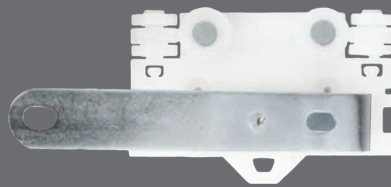

SM8R (Right Master Overlap)

Sold Individually

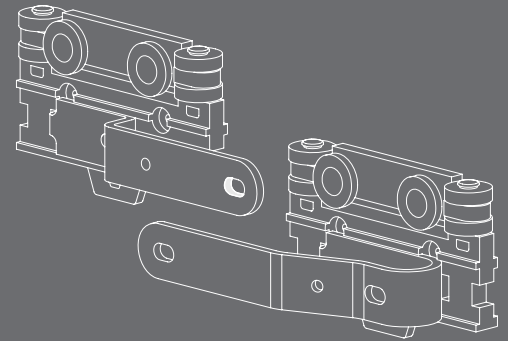

Ball Bearing Carriers

Reengineered, SmartSet™ ball bearing carriers offer the smoothest and quietest movement on the market today

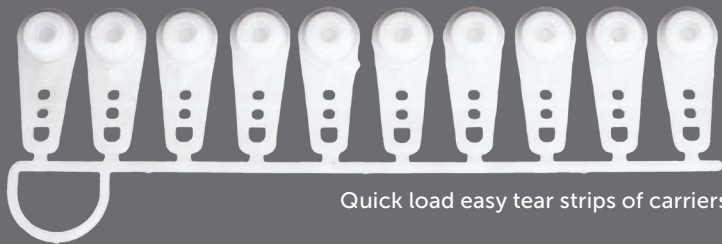

Quick load easy tear strips of carriers

SC16

Sold in Strips of 10

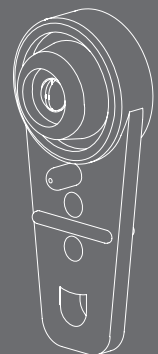

ICONIC
COLLECTION
Design • Evolution

Distributed by:

Unique Fine Fabrics Inc.

490 Rowntree Dairy Rd,
Woodbridge, Ontario
L4L 8H2

Tel: 905-851-8866 | Fax: 905-851-8846

Toll Free: 1-800-653-0783 | Toll Free Fax: 1-877-388-5252

email: sales@uniquefinefabrics.com | uniquefinefabrics.com

