



In partnership with



PEGASUS Tech



Description and technical features

1.1 MACHINE DESCRIPTION AND OPERATING PRINCIPLES

The machine is a washing centre for vehicles with one mobile gantry. This means that the gantry roll over the vehicle several times to wash and dry it, whereas the vehicle remains stationary for the whole cycle time.

The process includes a first washing phase with rotating brushes, followed by the drying phase during which the water is blown away from the vehicle surface by means of high pressure air flows. The brushes action is supported by the distribution of water and wash chemicals. Before the drying phase some wax is distributed on the vehicle's in order to make the water flow and obtain a polish finishing of the surfaces.

In addition to the phases of washing and drying, the PEGASUS TECH unit can carry out other processes that can be generally summed up in:

- pre-washing phase
- polishing phase.

A complete washing process is carried out according to the following sequence of operations:

1. pre-washing,
2. washing,
3. polishing
4. drying;

Each phase can be carried out in different ways.

The machine offers multiple choices also in the application of special products which help along the washing and finishing operation such as the pre wash cleaners, the waxes, the polishing products and the osmotic water.

The PEGASUS TECH units are equipped with options such as:

- systems for the distribution of hot/cold pre wash cleaner, inclinable for the front and rear of the vehicle.
- Systems for the distribution of active foam, white and Multicolor®.



- pre washing system with side and top high pressure water arches.
- pre washing system with side and top medium pressure water arches.
- shifting heads for high pressure washing Robowash®.
- wheels washer with or without distribution of chemical product
- WheelMaster high pressure wheel wash
- unit for the distribution of hot/cold and foamed waxes.
- unit for the distribution of polishing products.
- unit for the distribution of osmotic water.

One of the fundamental features of PEGASUS TECH, on top of the quality and speed of the different operations, is the possibility to carry out these operations in the same run, for example:

- Side high pressure with Robowash® or WheelMaster® together with the brush wash.
- Multicolor® active foam together with the brush wash.
- Waxing together with the drying.
- Osmosis water distribution together with the drying.

These features allow to shorten the cycle time, with a considerable increase of the unit capacity.

1.1.1 SERIES AND MODELS

PEGASUS TECH is available in two versions. One version features the well known contour following top drying system; the other one is equipped with two oscillating drying blowers that are fitted on the gantry top cross beam. The "AirPlus" range includes all machines that are equipped with the oscillating blowers.

All versions can be supplied with different working heights and widths as highlighted in the design on the side and in detail on paragraph 3.5.7.

In the following descriptions of the machine operation mode and of the technical equipment, we will make reference mainly to the version with the traditional contour following drying system.

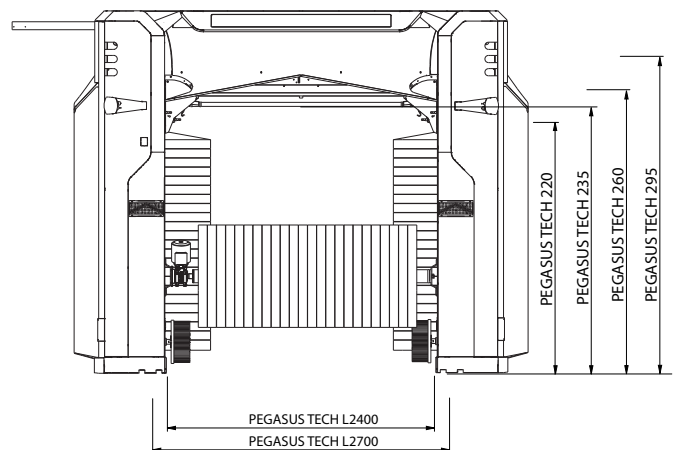

1.2 MAIN COMPONENTS

1.2.1 BLOCK LAYOUT OF THE MACHINE

1. Working area, marked on the floor and equipped with warning signals.
2. PEGASUS TECH washing unit
3. Gantry sliding rails.
4. Structure for the movement of the energy chain.
5. Control desk.
6. Self service control station (option)
7. Technical room (high pressure pumps, osmotic water, etc.)

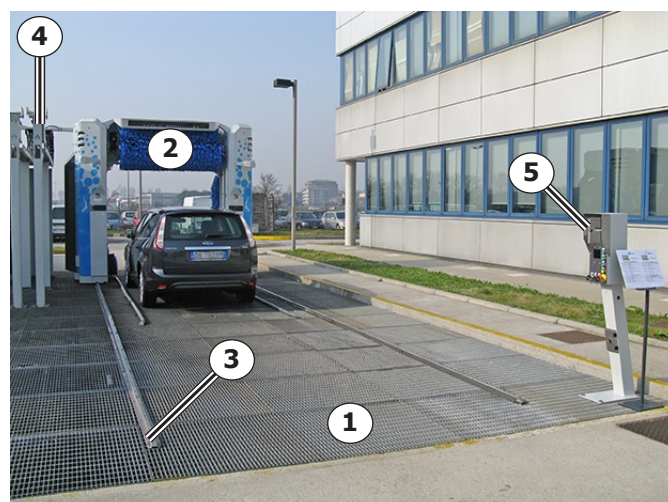

1.2.2 MAIN COMPONENTS OF THE MACHINE

1. Gantry column containing the electrical cabinet
2. Column containing the hydraulic equipment and wash chemicals
3. Top brush equipped with up and down movement (n. 1)
4. Wheel wash device, with rotating brushes (option)
5. Wheels driver vehicles (no. 2)
6. Gantry rails (no. 2)

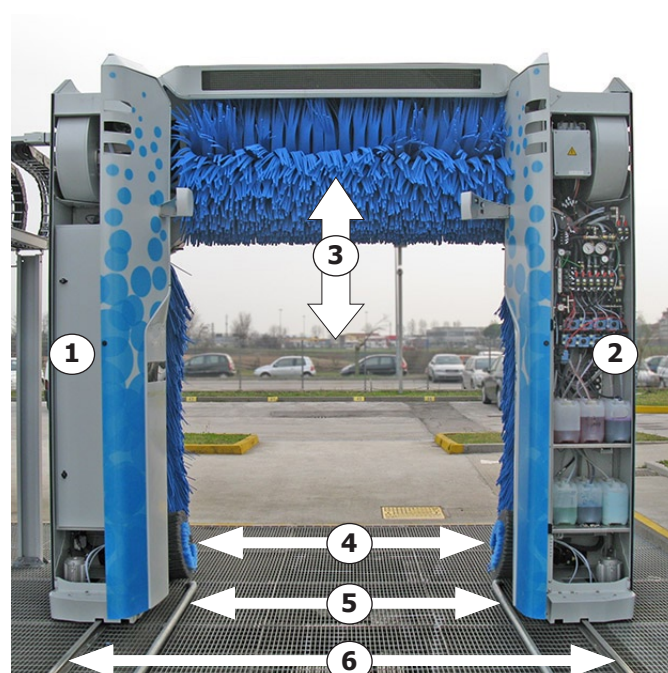

7. Signalisation and positioning device.



- 8. Splash guards (no. 2)
- 9. Side brushes (no. 2) with cross movement
- 10. Support frame of the cable and pipes energy supply chain.
- 11. Electrical box to connect the power supply and the external units.



12. The drying system includes:

- The horizontal working group includes one contour following nozzle, which moves up and down during the translation of the gantry over the vehicle.

The nozzle is equipped with two air blowers, fitted at both ends of the nozzle.

To increase the air flow efficiency, the top dryer is also equipped with the TSD system (patented). The unit can be optionally equipped with spraying nozzles for high or medium pressure wash and with pre-wash chemical nozzles.

- The vertical working group includes two side drying nozzles which are mounted on the opposite gantry columns. Each nozzle is equipped with one air blower, fitted on top of the relevant gantry column.

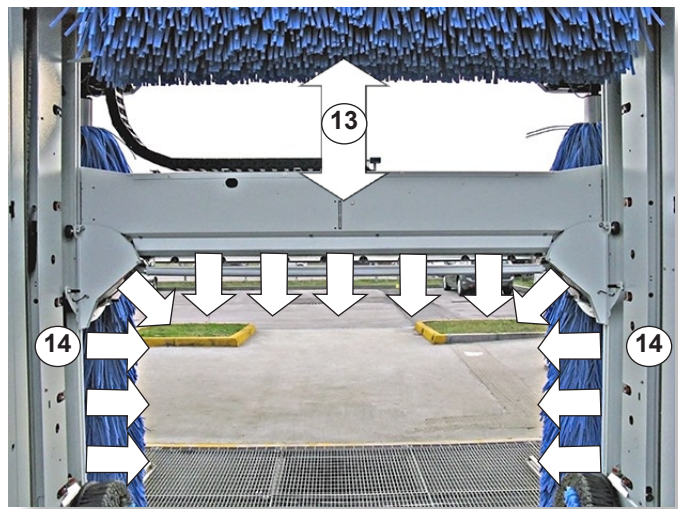

1.2.3 PEGASUS TECH AIRPLUS

The drying system includes:

- 1. Top section, including two oscillating drying nozzles, installed under the gantry top cross beam.
- 2. The vertical working group includes two side drying nozzles which are mounted on the opposite gantry columns. Each nozzle is equipped with one air blower, fitted on top of the relevant gantry column.



1.2.4 MAIN COMPONENTS INSIDE THE STRUCTURE

Left column

1. Left side blower
2. Electric cabinet



Right column

1. Right side blower.
2. Hydraulic and pneumatic switchboard
 - Compressed air connection
 - Water connections
 - Set of wash chemicals pneumatic dosing pumps.
3. Shelves of the wash chemical cans.

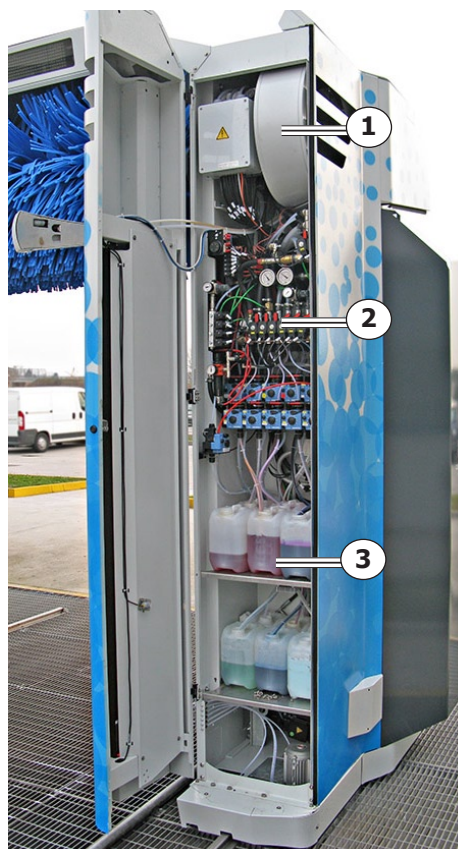

1.2.5 DESCRIPTION OF THE GROUP OF NOZZLES



Detailed information about the nozzles adjustment is given in chapter 7.

“Front shampoo” nozzles

“Front shampoo nozzles” are fitted in order to deliver shampoo and foam before the top brush. Two units are installed.

They can be used in the following ways:

- Distribution of white or multicolor foam during the brush wash.
- Distribution of water or multicolor foam, in the separate wash runs.
- Distribution of standard shampoo .
- Rinsing.



Top water nozzles

Two nozzle sets are installed to distribute water on the top brush.



Vertical water delivery arches

These nozzles are used to distribute water on the vehicles' sides and on the side brushes.

They can be used in the following ways:

- Distribution of white or multicolor foam during the brush wash.
- Distribution of water or multicolor foam, in the separate wash runs.
- Distribution of standard shampoo.
- Rinsing.



High pressure top and side nozzles

These nozzles have a double function:

- Distribution of pre-wash chemical with low pressure water to soften the grim and dirt.
- Removal of grim and dirt from the vehicle's surface with powerful high pressure water jets.

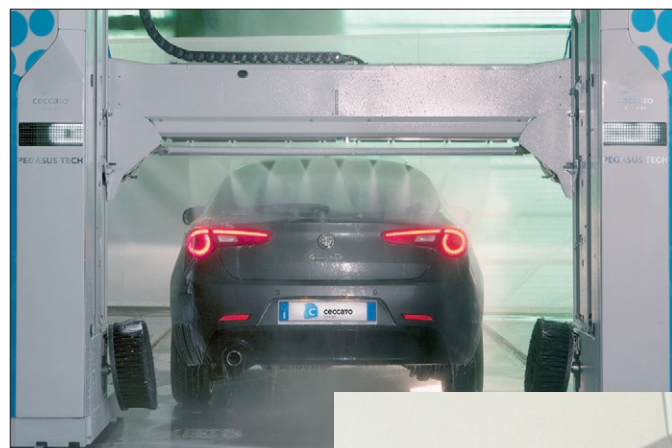

Rear nozzles

The nozzles can have following functions:

- Rinsing of the vehicles in forward run.
- Wetting of the surfaces before the side brushes in the backward runs.



Wax nozzles

Nozzles “waxes” equipped in two units, placed in the front part and out of the top brush. If there is the optional boiler, these nozzles can work with hot, tepid and cold water. They can be used in the following ways:

These nozzles are used for following functions:

- Distribution of wax beyond the top brush (during brush wash backward runs).
- Separate gantry wax run.
- Distribution of wax during the drying forward run.
- Separate gantry run with osmotic water.
- Distribution of osmotic water during the drying forward run.
- Rinsing.



1.2.6 "WHEEL MASTER" WHEEL WASHING DEVICE

This device consists of wheel washing brushes combined with high-pressure jets of water and detergent, and washes both the wheels (with detergent, high pressure and/or brush) and the sides of the vehicle (with detergent and/or high pressure).



If this device is not installed, a high-pressure side nozzle is present.

The device is provided with adjustable-angle telescopic guides optimized to aim the brush towards the centre of the wheel (adjustment depends on the size of the wheel and on the slant of centre-sloping floors).

This device also allows one to adjust the angle of the brush for using the jets on the wheels and sides of the vehicle.

When the wheel wash system is open and the side brush is in use, the product is ejected through the horizontal jets and the wheels are washed at high pressure.

The wheel wash has to be in physical contact with the wheels (with the side brushes and top jets) in order to clean them.

When the wheel wash is open and the brush is at an angle, the product is ejected through the inclined jets and the sides are washed at high pressure.

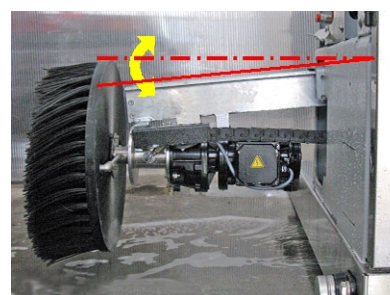

1.2.7 VEHICLE'S POSITIONING DEVICES

1.2.7.1 Lateral displays

The warning system consists of an electroluminescent display, placed on the side of the entrance of the two columns, which gives the following information:

- DRIVE IN = move the vehicle forward
- BACK UP = move the vehicle backward
- EMERGENCY = system in emergency status
- REPOSITION = reposition the board
- STOP = stop of the vehicle
- WASH IN PROGRESS = wash cycle in progress
- DRIVE OUT = remove the vehicle from the bay

The display of the message is determined by the interception of two inclined photocells which detect the presence of the vehicle in the bay.



1.2.7.2 Positioning start board (option)

It is a vehicle's position device that can be installed as an alternative to the standard photocells system. The customer must drive the vehicle forward and place the left front wheel in the centre of the start board, following the indications of the traffic lights.

1.2.7.3 Digital text display

These devices can be installed on the top of the system, both in the vehicle entrance side (A) and in the exit side (B), and represent a very effective means to supply information to the car wash user. They consist of a programmable led panel that can visualize texts in a dynamic way, with horizontal or vertical movements, with different graphical effects. The information can include: instructions for the positioning of the vehicle, information about the wash phase, alarm messages, machine state messages, date, time, programmable advertising messages, etc.



1.2.7.4 Buzzer

The machine is equipped with a sound alarm to indicate:

- start of the washing cycle
- end of the washing cycle
- re-positioning of the gantry
- beginning of the phase of automatic frost protection

1.2.8 CONTROL DEVICES

1.2.8.1 Control panel

The standard control board of the machine, shown in the picture on the side, is installed on top of a column anchored to the floor, outside the dangerous area.

At the side of this column it is possible to place another support post equipped with the payment system or with the additional pushbutton panel.

The panel is divided in two parts:

1. Operator panel
2. Electromechanical controls and signals.

1.2.8.2 Operator's panel

Operator panel with soft-touch keyboard and back lighted LCD display.

Following functions and controls are possible from the operator's panel:

- Information about the state of the machine, the current wash cycle, the alarms.
- Selection of the wash cycle.
- Customization of the programs
- Visualisation of statistical data.

The access to the system parameters is limited by two-level passwords.

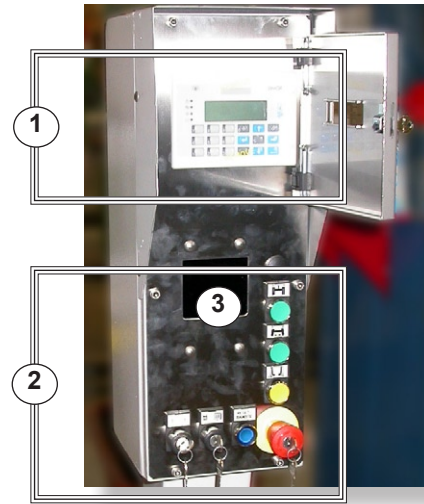

Further information is given in the enclosed relevant programming manual.

1.2.9 SUPERVISION AND CONTROL DEVICES

1.2.9.1 Telecontrol system

The telecontrol system also allows remote data processing and can be connected either through a GPRS or ADSL network, providing real-time information on the status of the unit and allowing immediate action in case of malfunctions.

The system allows to:

- manage 6 USER LEVELS with independent settings
- send text messages (SMS) or emails containing alarm warnings, cycle counter data or unit data
- receive requests to send data by SMS
- manage the ALARM LOG.
- view WEB PAGES for unit control and management
- view CASH and REVENUE status
- view the wash bays via multiple webcams

Once recognized by the system through a password, any enabled user can send an encoded SMS requesting the sending of:

- total and daily cycle counter data
- unit status
- alarms and events report

Enabled users can also request the sending of a emails with the following information:

- total and daily cycle counter data
- alarm log ed events report

By connecting via Web, authorized users can:

- manage a multi-user connection
- view the list and status of the units
- view a synoptic diagram showing the status of the units
- send and reply via SMS or EMAIL to messages from other users (even for units not connected through GPRS)
- send SMS messages in any of the languages available
- Configure the alarm and control settings
- Look after the system's filters over time
- Export data
- Analyse statistics concerning alarms, events and revenue
- Compare and contrast analyses of different systems
- Create reports and graphs

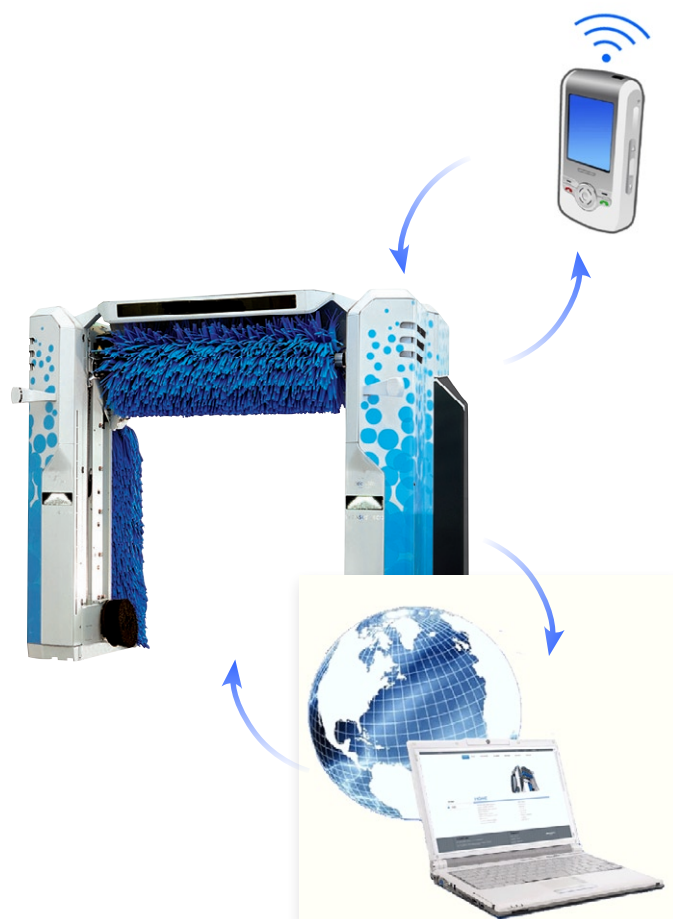

1.2.10 SELF SERVICE CONTROL DEVICES (optional)

1.2.10.1 SIMPLY COIN AIR coin acceptor

Coin acceptor, ideal for outdoor use with small to medium sized systems.



1.2.10.2 AUTO COIN coin/banknote acceptor

Coin/banknote acceptor for outdoor use with medium to large sized systems.



1.2.10.3 SIMPLYSTART activator for car wash

Automatic payment machine able to give change and change banknotes, or change and dispense coins for additional services.

It can be configured with 4 to 6 washing programs and has an emergency stop and system repositioning and reset buttons.



1.2.10.4 PITPOINT PLUS activator for car wash

Automatic payment machine that can be configured with 6 separate washing programs.



1.2.10.5 PSD CODAX

The device includes a main unit (A) with printer, placed in the kiosk and a remote unit (B) usually placed close to the washing machine. After payment, a ticket with a random code is issued by the main unit. The user goes then to the remote unit and digits the number on the keyboard to start the washing cycle.

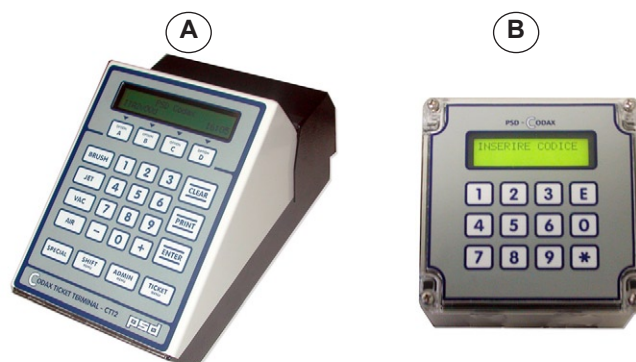

1.3 LIST OF THE OPTIONS

Supervision and control devices

- Remote diagnostic through SMS
- Remote diagnostic through WEB

Self-service payment systems

- Banknotes, coins and key reader
- Standard cards reader
- Magnetic cards reader
- PSD Codax

Vehicle's positioning devices

(Front digital text display - standard).

- Rear and external display
- Start board
- Wheel driver
- Addition photocells for cycles in short bays

High and medium pressure pre washing

- Total high pressure in one run
- Total high pressure in two runs
- Side high pressure in one run
- Side and top medium pressure
- Robowash / WheelMaster, can be linked to any of the above options.

Washing groups

- Wheel wash brushes
- Underchassis wash

Special treatments

- Side pre wash chemicals
- Directional top pre wash arch (front-rear)
- Programmable multicolour foam (MFS)
- Active foam
- Foam wax
- Additional wax
- Foam Polish polishing system
- Sonax polishing system
- Wheel rims cleaner
- Hot pre wash chemical - wax
- Rinsing with osmotic water

Brushes

(Standard brushes in polyethylene).

- Foam touch
- Fabric
- Other kinds of brushes on demand.

Auxiliary device

- Boiler
- Osmotic water
- Hydraulic drive short track device
- Automatic frost protection
- Doors control

Claddings and brushes colours

- White RAL 7035
- Grey RAL 7016
- Other configurations and colours upon request.

Other options

- Coloured or transparent side guards
- Installation of chemical products outside
- Centralised manual lubrication

1.4 CONVENTIONS

Gantry forward movement

FORWARD movement means that the gantry is in front of the vehicle and moves forward to get close to it .

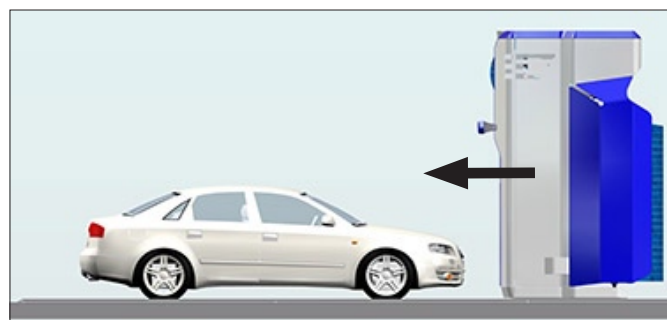

Gantry backward movement

BACKWARD movement means that the gantry is in front of the vehicle and moves backward to get away from it.

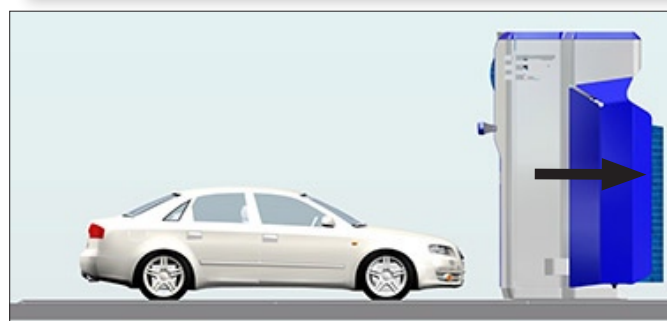

Left and right side

The definitions "right" and "left" refer to the front view of the machine, the vehicles' entry side

- A. Left side.
- B. Right side.

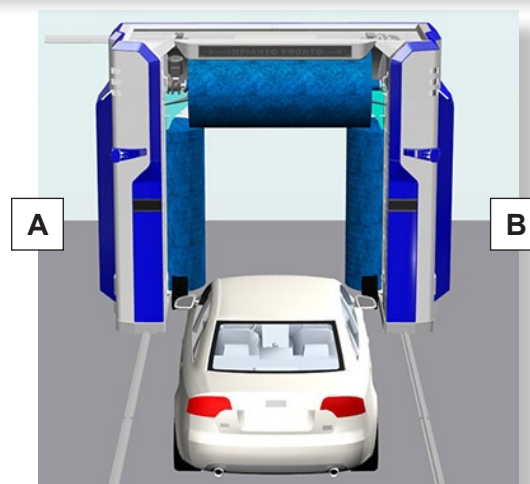

Brushes rotation

The direction of rotation of the brushes can be either "climbing" or "counter-rotating" in relation to the gantry movement.

"Climbing" rotation

See figure C

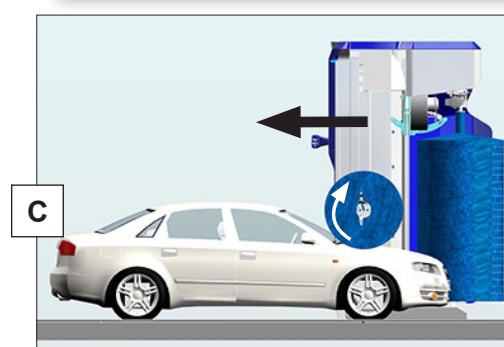

"Counter-rotating"

See figure D

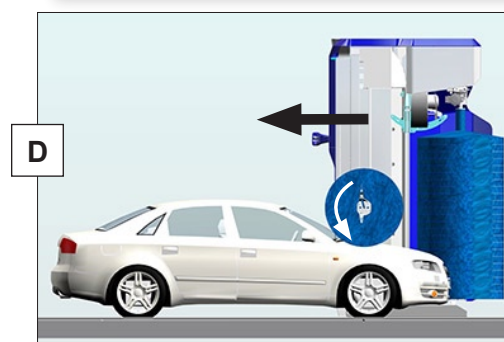

These indications are the same for the side brushes.

1.5 TECHNICAL FEATURES



Except where expressly indicated, the technical data given in the next paragraphs applies to all PEGASUS TECH versions.

1.5.1 CONNECTIONS

Recycled water..... G 3/4"

Clean water G 1/2"

Water pressure..... 3-4 bar (45-60 PSI)

Compressed air..... G 1/4"

Air pressure 7-8 bar (100-115 PSI)

Osmotic water..... G 1/2"

			PEGASUS TECH 220 - 240 - 260	PEGASUS TECH 295
Max power absorption (*)	with boiler	kW (Hp)	20,5 (27,5)	23,5 (31,5)
	without boiler	kW (Hp)	14,5 (20)	17,5 (23,5)
Max power required (*)	with boiler	kW (Hp)	25,5 (34)	28,5 (38)
	without boiler	kW (Hp)	19,5 (26,5)	22,5 (30)
Power supply		V	See plate	
Frequency		Hz	See plate	

(*)Power absorbed by the light panel, pumps and other is not included.

Please see following table to calculate the total installed power of a given configuration

Pumps power	kW (Hp)
Recycled water supply pump	1,5 / 3 / 4 (2 / 4 / 5,5)
Fresh water supply pump	1,5 / 3 / 4 (2 / 4 / 5,5)
Robowash / WheelMaster feeding pump	5,5 / 7,5 (7,5 / 10)
No. 1, 2 or 3 high pressure feeding pumps	7,5 (10)
Medium pressure feeding pump	5,5 / 7,5 (7,5 / 10)
Underchassis feeding pump	5,5 (7,5)

1.5.2 REQUIRED ENVIRONMENTAL CONDITIONS FOR MACHINE EXPLOTATION

The washing unit can be installed:

- on forecourts, in the open air;
- indoor, in suitable wash bays;
- in service stations, at a distance of minimum 10 m (32ft) from gasoline / diesel oil / gas filling pumps and from the fuel tanks filling pits; in any case well outside of the dangerous zones classified under the norms in force;
- at a distance of at least 10 m (32ft) from residences or other buildings used for commercial activities, offices or business;
- allowed operation temperatures: +1/+40° C (33.8-104°F), also with the presence of persons;
- relative humidity: 80 % maximum;
- maximum height above sea level: 1500 m (4900 ft), in case of higher altitudes please contact Ceccato technical assistance;
- absence of corrosive, combustible or explosive dust;
- absence of corrosive and combustible liquids and aerosol products.



Special contractual agreements are necessary if above conditions cannot be met.

1.5.3 QUALITY OF THE WATER

The correct operation of the washing equipment is granted only if the water used for the washing process is in compliance with the following characteristics:

FRESH WATER

Parameter		
pH		6-8
Hardness	°F	<30
Total suspended solids	mg/l	<10
TDS (total salinity)	mg/l	<3000
Turbidity max	NTU	1
Free chlorine	mg/l	-
Iron	mg/l	<2

RECYCLED WATER

Depending on the system, it is possible to guarantee 70-80% of water reuse.

Parameter		
pH		6-8
Hardness	°F	<30
Total suspended solids	mg/l	<15
COD	mg/l	<200
Total hydrocarbons	mg/l	<5
Total surfactants	mg/l	<2

If above parameters are not met, the Manufacturer is at your disposal to study and propose the most suitable water treatment solution to obtain the required water quality.



- It is not possible to use recycled water with the features reported in table to supply the softened and osmosis unit.
- No large material must be found in the infeed water (stones, bags, leaves) which could damage the system's feed and the high-pressure pumps.
- For the discharge of the waste water of the vehicle wash operation into the city sewer, follow the local regulations.

1.5.4 WASH CHEMICALS CONSUMPTION

When using Ceccato wash chemicals, the dosing pumps shall be adjusted in order to obtain a consumption per cycle as shown in the diagram on the side. The consumption data are referred to the wash of vehicles with average length of 4,5 m and to an ambient temperature of 10-12 °C. The wash chemical delivery rate shall be reduced if the temperature is higher.

Ceccato Chemicals	Consumption per cycle (ml)
Pre-Wash Cleaner	20-30
Wheel Rim Cleaner	20-30
Foam Shampoo	10-20
Brush Shampoo	5
Multicolor Yellow PRO	20-30
Multicolor Fucsia PRO	20-30
Multicolor Blue PRO	20-30
Wax Plus	20-25
Polishing Wax	30-35

1.5.5 PROPERTIES OF THE CHEMICAL PRODUCTS

Product	Ceccato Code	pH of concentrated product	Material of gaskets on dosing pump	Characteristics
Pre wash cleaner	832198	11-12	EPDM	It must not attack aluminium, similar alloys and paintwork, even in the hot season.
Brush shampoo	832234	3-4	EPDM	It must be easy to rinse off and the degree of foam must be controllable. It is important the shampoo can be mixed with the other detergents used for the washing process and can help protect against limescale.
Foam shampoo	832233	3.5-4.5	EPDM	It must have a highly foaming effect, for use in small quantities (20 g/cycle). It must not leave whiteish residue and the pH must be slightly acid to remove grime. The foam shampoo must contain an agent that can prevent the redepositing of dirt, and well lubricate the brushes to reduce friction between these and the surfaces of the vehicle.
Multicolor	832249 832250 832251	11.5-13.5	EPDM	It must be a true pre-washing cycle, not only a neutral PH foaming, with an anti-static cleaning action, easy to rinse and it must not leave any mark. It also must be compatible with nanostructured polymer based wax to be used during the subsequent phase. If incompatible waxes are used, residuals or deposits may form in the pipes.
Rim detergent	832235	13-14	EPDM	This must contain a suitable amount of inhibitor so as not to attack the parts in contact with the spray circuit or damage the bodywork of the vehicle in the event of contact. It must not be acid, otherwise it could attack and damage the spraying system and concrete bay.
Polish	832184	9-10	EPDM	It must not solidify or build up in layers in its container or in the nozzles when sprayed out.
Sonax	832207	7-8	EPDM	Exclusive supplier: Sonax
"Cera plus" wax	832236	4-5	VITON	It must not contain silicone or insoluble polymers that can form residue in the pipes. In general, the wax must not contain any greasy substances or mineral oils that could "soil" the brushes of the washing system and smear the windows of the vehicle.
"Super cera" wax	832237	4-5	VITON	It must not contain silicone or insoluble polymers that can form residue in the pipes. In general, the wax must not contain any greasy substances or mineral oils that could "soil" the brushes of the washing system and smear the windows of the vehicle.

1.5.6 MAXIMUM VEHICLE SIZE

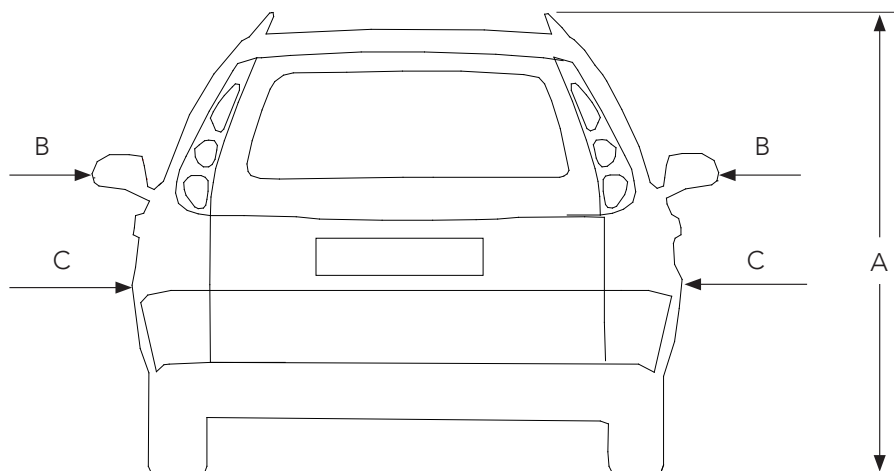

		PEGASUS TECH			
		220	240	260	295
Washing useful heights	A	2200 (86")	2350 (92")	2600 (102")	2950 (116")
Max. passage width	B	2400 / 2700 (94" / 106") **			
Washing useful width *	C***	2100 / 2400 (82" / 94") **			

* bodywork without ledges (mirrors, etc.)
 ** PEGASUS TECH LARGE
 *** Vehicle with normal shape and correctly positioned in the middle of the wash bay

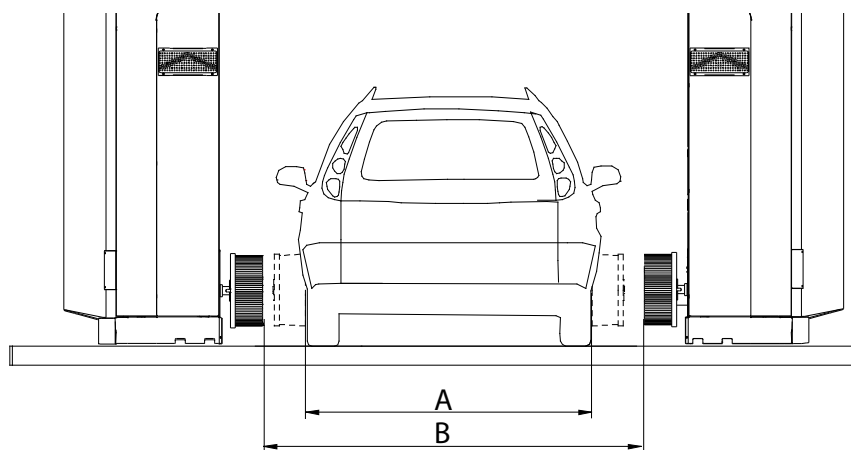

1.5.7 WHEEL WASH UNIT OPERATION LIMITS

	PEGASUS TECH STD	PEGASUS TECH LARGE
(A) Minimum distance between wheels mm (in)	1120 mm (44")	1420 mm (56")
(B) Max. wheel wash passage width mm (in)	2040 mm (80")	2340 mm (92")



The wheel wash width may be adjusted ± 6 cm

1.5.8 USEFUL WASHING LENGTH

1.5.8.1 Unit with standard rail length

With the standard length rails of 9 metres (29ft ^{1/2}) is possible to carry out a complete wash of a 5,3m (17ft ^{1/2}) long vehicle, as shown in the following drawing.

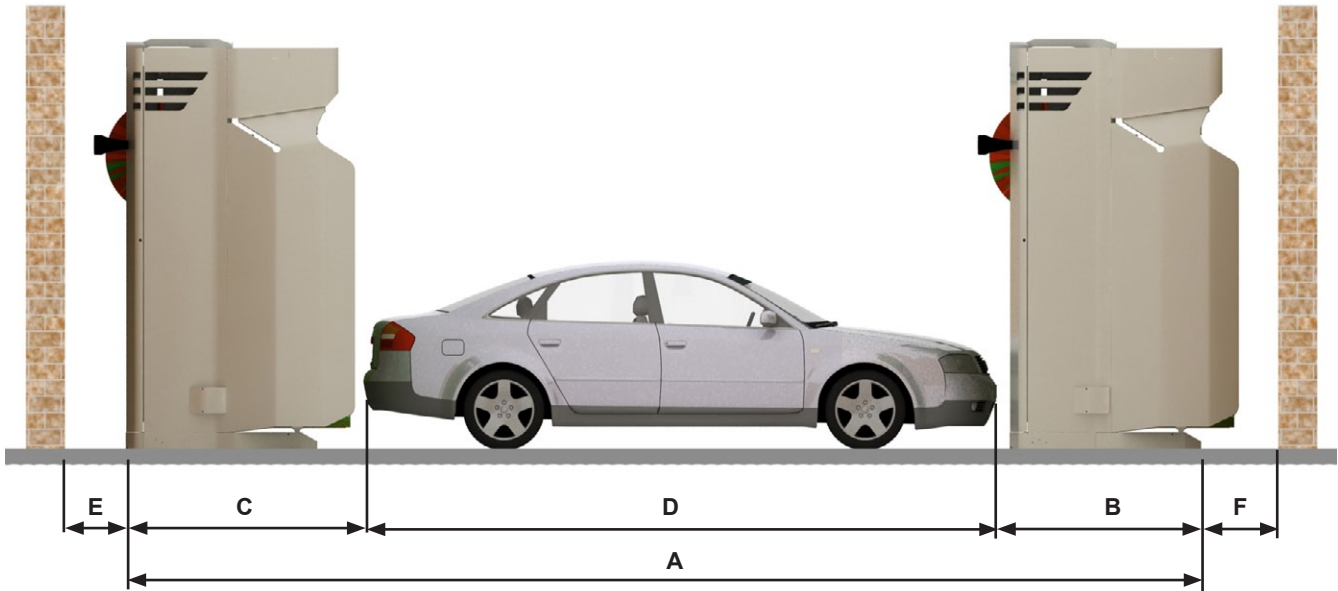

Legend

- A. Standard rail length: 9000 mm (29ft ^{1/2})
- B. Space needed in front of the vehicle: 1690 mm (5ft ^{1/2})
- C. Space needed behind the vehicle: 2000 mm (6ft ^{1/2})
- D. Maximum vehicle length: 5300 mm (17ft)



In case of indoor installation, check the minimum distances from the machine side frames to the walls and the space remaining between the machine and the entry and exit walls/doors when the unit is positioned on both rails limit switches ($E > 410$ mm [17"] and $F > 530$ mm [21"]).

1.5.8.2 Unit with special rail length

Increasing the rail length

By increasing the rails length, the washing length will be increased by the same length.

Rail length m - (ft)		Vehicle length m - (ft)
(standard)	9 - (29 ^{1/2})	5,3 - (17 ^{1/2})
	10 - (32 ^{3/4})	6,3 - (20 ^{3/4})
	11 - (36)	7,3 - (24)

Decreasing the rail length

By diminishing the rails length, the washing length will be decreased by the same length. Please take into account that the machine will in any case carry out the wash cycle. The wash will be completed on all those vehicles which length is compatible with the rails size, whereas some of the operations could be carried out only partially or not carried out at all on longer vehicles.

Rails length m - (ft)		Vehicle length m (ft)
(standard)	9 - (29 ^{1/2})	5,3 (17)
	8 - (26 ^{1/4})	6,3 (20)
	7 - (23)	7,3 (24)

1.5.8.3 Unit with "short bays" photocell

The installation of this device in short bays allows an increase of the washing length of at least 60 cm.(23^{1/2})

- Maximum vehicle's wash length with standard rails will be 5,9 m (232")

1.5.8.4 Units with short-track device

With the installation of the short-track device, the washing length can be increased by 1,3 m (51") in relation to the standard.

- Maximum vehicle's wash length with standard rails will be 6,6 m (260")

1.5.8.5 Units with start board (threadle) positioning

On machines equipped with standard rails, the washing length could be diminished up to 500 mm (19^{3/4}), depending on the length of the vehicles' fore carriage.

Longer rails should be installed to solve this problem, taking into account that the overall length required to install the machine will be increased.

- Maximum vehicle's wash length with standard rails will be 4,8 m (189")

1.5.9 SIZES

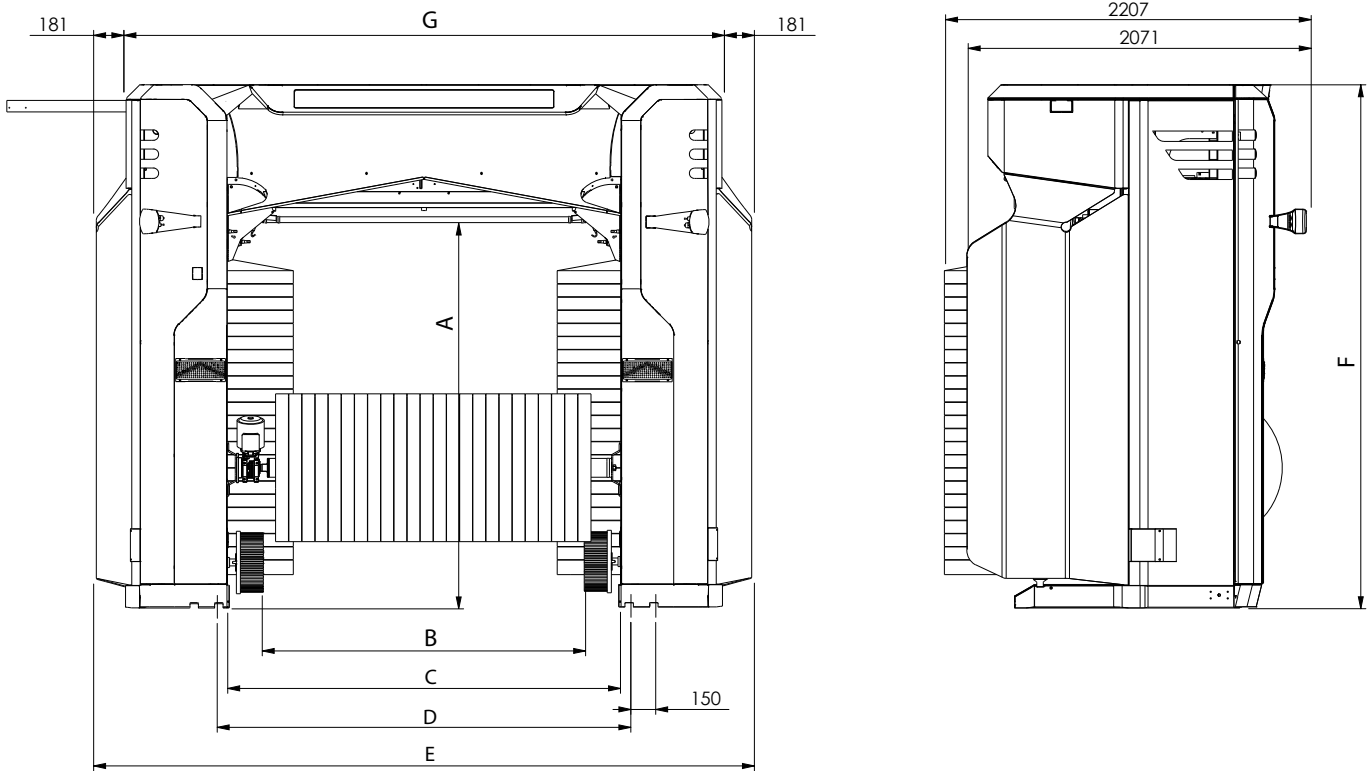

			PEGASUS TECH			
			220	240	260	295
Total weight	kg	(lb)	1600 - 1700 (3500 - 3800 #)			
Height (A)	mm	(in)	2220 (87 ¹ / ₂)	2370 (93 ¹ / ₄)	2620 (103 ¹ / ₄)	2970 (116 ³ / ₄)
Width (B)	mm	(in)	2000 / 2300 (78 ³ / ₄ / 90 ¹ / ₂ #)			
Width (C)	mm	(in)	2400 / 2700 (94 ¹ / ₂ / 106 ¹ / ₄ #)			
Rails distance (D)	mm	(in)	2500 / 2800 (98 ¹ / ₂ / 110 ¹ / ₄ #)			
Width (E)	mm	(in)	3990 - 4290 (157" / 168 ³ / ₄ #)			
Height (F)	mm	(in)	3060 (120 ¹ / ₂)	3210 (126 ¹ / ₄)	3460 (136 ¹ / ₄)	3810 (150")
Width (G)	mm	(in)	3630 - 3930 # (143" - 154 ³ / ₄ #)			

(#) PEGASUS TECH LARGE

1.5.10 INDOOR INSTALLATION

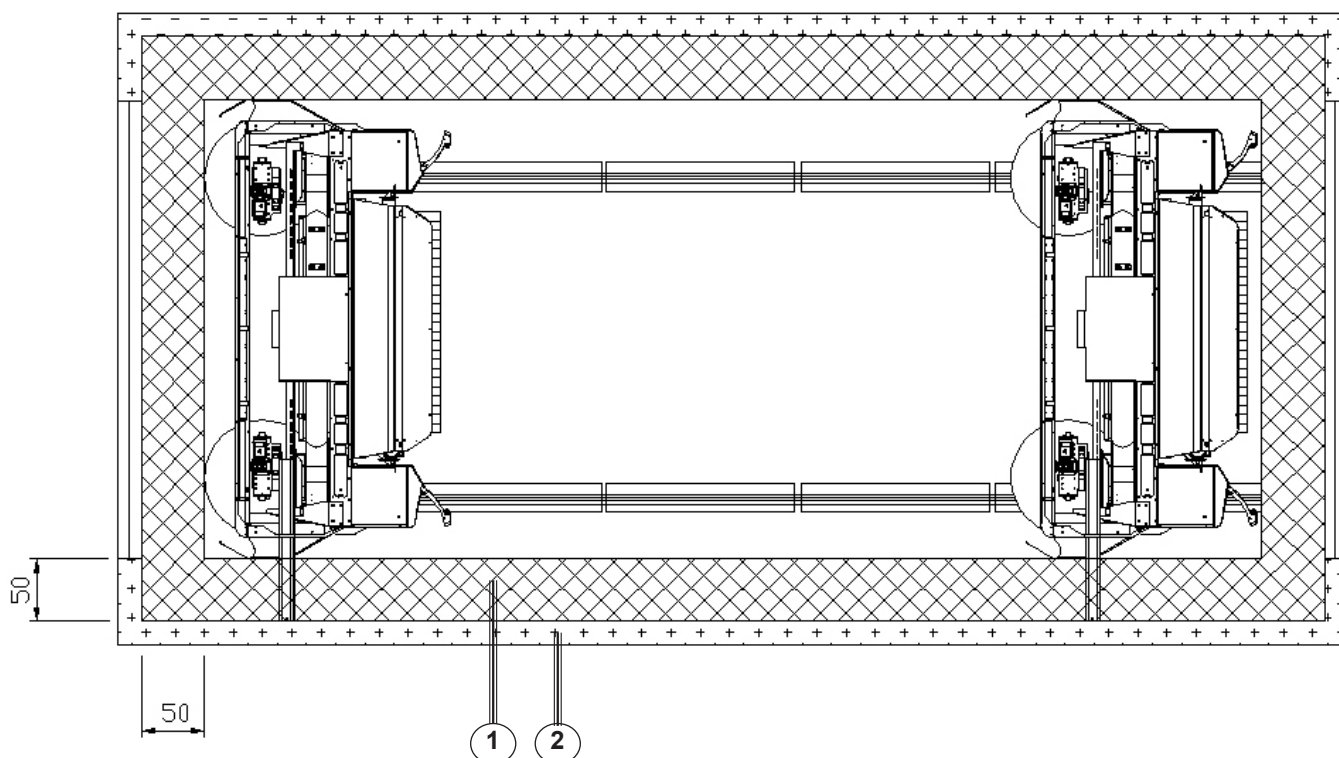

The washing unit PEGASUS TECH can be installed in closed bays.

In compliance with the applicable technical norms, if the machine is installed in a closed bay, there shall be at least 50 cm (19^{3/4}) of free space (1) around the perimeter (2) which encloses the working area of the unit.

When the necessary space is restricted, for example by columns, the minimum safety distance must be increased by the size of said obstacles.

If, for any reason, such space is not available, it is compulsory to install specific safety devices, see paragraph 4.4, chapter 4.

If the safety devices are installed later on, for example after moving the machine to another site, the engineer in charge of the installation shall supply an updated handbook, or add following documents to the existing manual:

- technical cards and drawings;
- commercial components certificates;
- description of system operation;
- analysis of risks.



The safety system described above becomes part of the washing unit and therefore must be tested with it.



- As for the dimensions, see the foundation plan of the specific unit.
- Further information on this issue is given in chapter 4.

1.5.11 OPEN AIR INSTALLATION

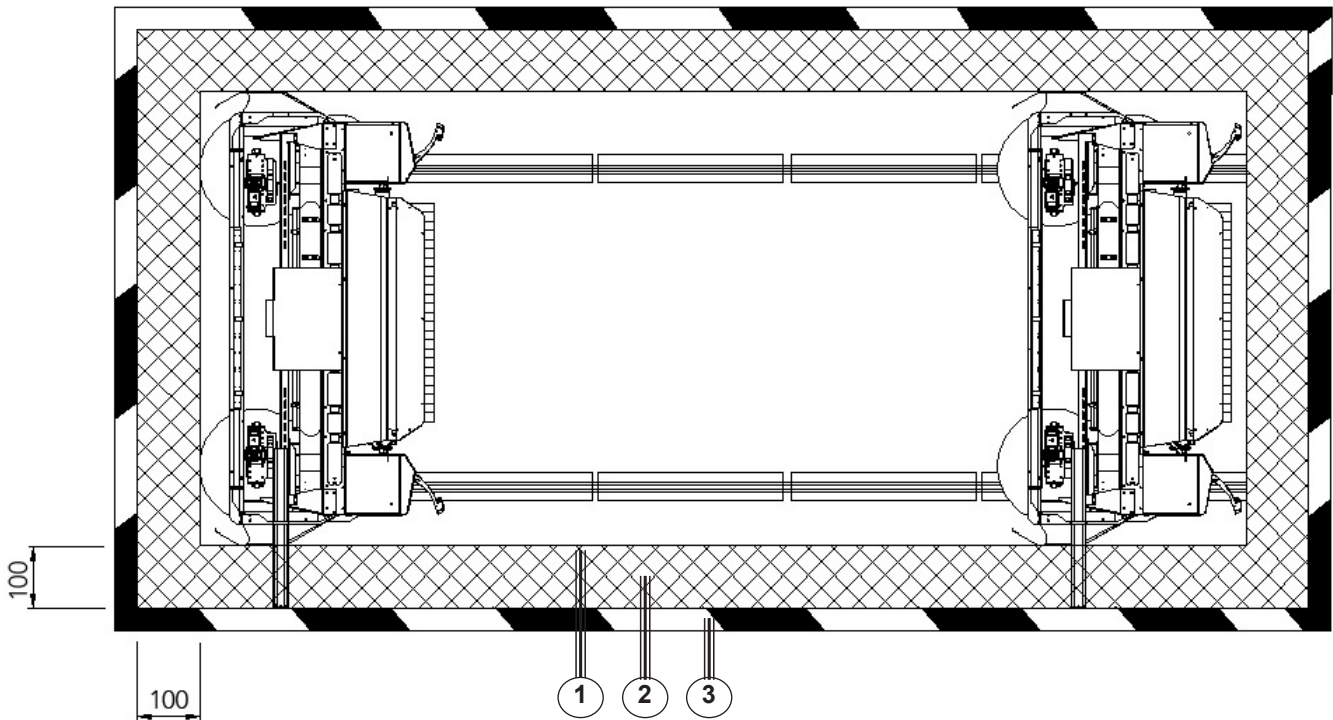

It is necessary to leave at least 100 cm (39^{1/2}) free space (2) around the perimeter (1) which encloses the working area of the unit.

The area should be marked by yellow and black stripes (delivered with the machine) on the floor (3). The stripes shall be fixed to the floor after completing the installation of the machine and before the unit is handed over to the customer.

The information signs dedicated to the operation area must be fixed to suitable support boards that will be placed on the external perimeter of the wash bay in such a way that they can be easily seen by customers (see par. 4.5.3).



The installation work can not be considered as completed if the working area has not been marked with the coloured bands and the warning panels are not in place.



Further information on this issue is given in chapter 4.

1.5.12 MIXED INSTALLATIONS - Guidelines

“Mixed” are those open air installations where there are some side and/or front limitations.

In these cases it is necessary to comply with the norms in force for both types of installation; for the open air part it is compulsory to limit the dangerous area with yellow and black stripes, while for the area with side or front obstacles the same safety devices used in the closed bays should be installed.



The above described norms regarding the safety devices to place when the space around the machine is less than 50 cm (19”3/4), are valid also in case there is only one concerned point in the whole perimeter of the unit’s area (for example a column, part of side wall, etc).

If, after the preliminary checks of the safety conditions of the selected installation area, the safety requirements described in the previous paragraphs are not granted, please do not proceed with the installation of the machine, but get in touch with the Manufacturer’s technical department for instructions.

1.5.13 NOISE LEVEL

The sound level has been measured in compliance with the norm ISO 3746, using the control method of surface enveloping on a reflecting plane.

The table below shows the noise levels that are generated by the machine during the phases of brush washing, high pressure washing and drying.

PHASE	Sound pressure level db(A)
Brush wash	92,4
High pressure wash	101,9
Drying	100,4

Alongside is an indicative diagram of the noise levels according to distance (in db(A), at 5, 10, 15 and 20 metres from the source).



The User shall inform the site personnel about the danger connected to the noise level and comply with the relevant local norms.

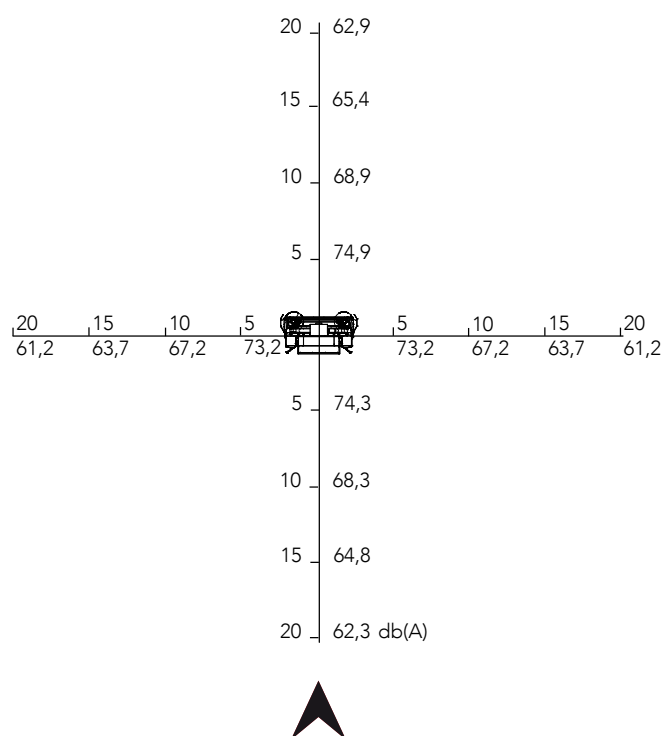

1.6 PRE-ARRANGEMENTS AND SUPPLIES

1.6.1 TO BE PROVIDED BY THE USER

The User is in charge of the following supplies, if not otherwise agreed:

- Preparation of the installation area including possible civil works and/or required ducting.
- Power supplies necessary for the machine operation and their connections in compliance with the local norms.
- Preparation of an efficient earth system and specific connections in compliance with the local norms.
- The supply of the required ancillary hydraulic components, such as pumps, water softeners, etc.)

A detailed hydraulic and pneumatic connection plan is supplied together with this handbook. Please consult it for all technical data and details.

Concerning the electrical connection, please consult the enclosed wiring diagram where you can find following information:

1. number of phases;
2. minimum cables section;
3. installed power;
4. maximum absorbed power;
5. characteristics of the current operated earth leakage circuit breaker to protect the power supply line.



The data of items 1,2,3,4 are written also on the machine identification plate (see paragraph 1.4.2 chapter 1).

1.6.2 MACHINE KEYS

The machine is supplied with following keys:

1. One pair of keys to open the door of the electrical cabinet and the door of the cabinet containing the wash chemical cans on the gantries' columns.



For shipment reasons, all keys are placed inside the gantries' columns, which are kept closed during transportation by plastic straps.

2. One pair of keys to unlock the switch-on selector of the machine.
3. One pair of keys to lock or unlock the selector switch for the activation of the machine operation in self-service mode.
4. One pair of keys to lock or unlock the emergency stop button on the remote control panel.



All keys supplied with the machine shall be kept in a safe place and accessible only for authorized personnel.



The use of the keys, items 2-3-4, is described in chapter 6, paragraph 6.2

1.7 PROGRAMMES - TIMES – CONSUMPTIONS

In the following table are listed some typical washing programmes, with the relevant cycle times and consumptions, measured on a medium length vehicle.

Program			runs	Time	Recycled water	Clean water	Air	Power	Smoothers	Shampoo Foam	Wax	Super wax	Sonax	
					litre	litre	litre	kW/h	g	g	g	g	g	
					gal.	gal.	gal.	HP/h	oz	oz	oz	oz	oz	
					gal. (uk)	gal. (uk)	gal. (uk)							
1	Forward:	Wax + Drying	2	1'40"	-	15	-	0.55	-	-	12	-	-	
	Return:				Drying		4		0.74			0.45		
2	Forward:	Washing + Shampoo	4	3'10"	60	15	5	0.71	-	20	12	-	-	
	Return:				Washing + Wax	16	4	1.5	0.95		0.7	0.45		
	Forward:				Drying	13	3.3	1						
3	Forward:	Washing + Shampoo + Finishing	4	3'40"	70	15	20	0.74	-	22	12	-	-	
	Return:				Washing + Finishing + Wheels washer + Wax	19	4	5	1		0.78	0.45		
	Forward:				Drying	15	3.3	4						
4	Forward:	Multicolor /PreFoam+ Washing + Finishing + Side high pressure + Robowash	4	3'40"	120	25	50	1.30	-	26	18	-	-	
	Return:				Washing + Finishing + Wheels washer + Hot wax	32	7	13	1.74		0.9	0.65		
	Forward:				Wax + Drying	26	6	11						
5	Forward:	Multicolor	6	4'30"	75	15	60	0.94	-	26	-	15	-	
	Return:				Washing + Finishing + Wheels washer washing + Finishing	20	4	16	1.25		0.9			
	Forward:				Hot wax	17	3.3	13						
6	Forward:	Hot smoother	6	5'10"	160	25	70	1.72	80	20	18	-	-	
	Return:				Total high pressure	42	7	19	2.3	3	0.7	0.65		
	Forward:				Washing + Shampoo + Finishing + Wheels washer	35	6	16						
7	Forward:	Multicolor	8	7'30"	120	15	140	1.5	-	26	12	-	100	
	Return:				Washing + Finishing + Wheels washer Washing + Finishing+ Side high pressure + Robowash	32	4	37	2		0.9	0.45		3.5
	Forward:				Formel Plus Sonax	26	3.3	31						

8	Forward:	Hot smoother	10	8'20"	160	25	130	1.83	-	26	12	-	100
	Return:	Total high pressure											
	Forward:	Washing + Shampoo + Finishing + Wheels washer											
	Return:	Washing + Finishing + Hot wax											
	Forward:	Drying											
	Return:	Formel Plus Sonax											
Forward:	Sonax Brushing	42	7	34	2.5		0.9	0.45	3.5				
Return:	Hot wax												
Forward:	Wax + Drying												
Return:	Drying												

1.7.1 EXPLANATION OF THE DATA

- The measurements were taken using a standard vehicle with a length of 4,5 m (15ft);
- The chemical products used are the ones recommended by Ceccato (please contact the Sales Department of Ceccato s.p.a.).
- The power consumption data include following pumps:
 - fresh water supply pump, 1.5 kW (1,5HP);
 - recycled water supply pump 1.5 kW (1,5HP);
 - Robowash or WheelMaster feeding pump, 5.5 kW (7,5HP);
 - side high pressure pump, 7.5 kW (10HP);
 - top high pressure pump, 7.5 kW (10HP).