

Knock Down Bar/Sampling Station

The Portable Popup Bar is a portable, wheeled sampling and serving station perfect for any event. The pre-assembled aluminium frame comes together by unfolding the legs, and inserting the interior shelf panels. Fully-customized graphics and printed top will win visitors over as you provide an effortless serving experience.

features and benefits:

- Portable, pre-assembled aluminium frame
- Zipper-enclosed storage space
- Printable graphics available
- Locking wheel casters
- Kit includes frame, four shelves, and a carry bag
- 1 year hardware warranty against manufacturer defects



Included In Your Kit

Tools, Components, & Connectors

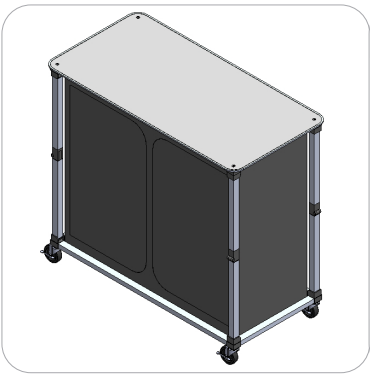

Large Portable Popup Bar x1

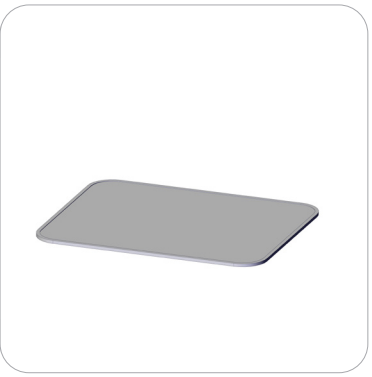

SHELF x4

Kit Assembly

Step by Step

Step 1.

Unfold and lock legs.

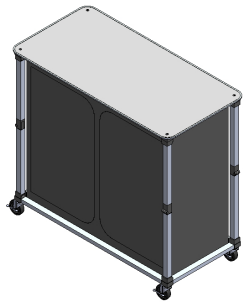

Step 2.

Unzip and insert shelves.

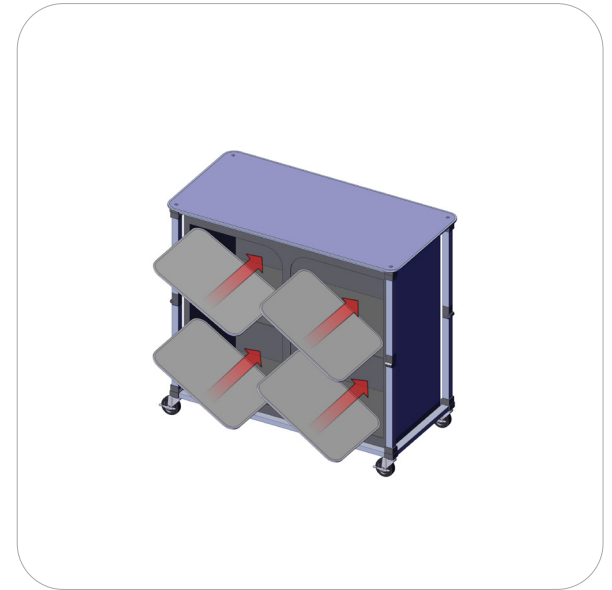
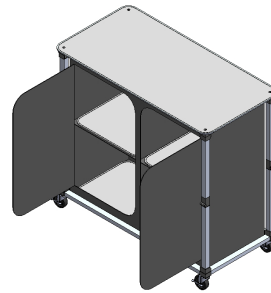

Step 3.

Zip door to close or roll up velcro to stay open.

If graphics have been purchased move on to step 4, otherwise Set-up is complete.

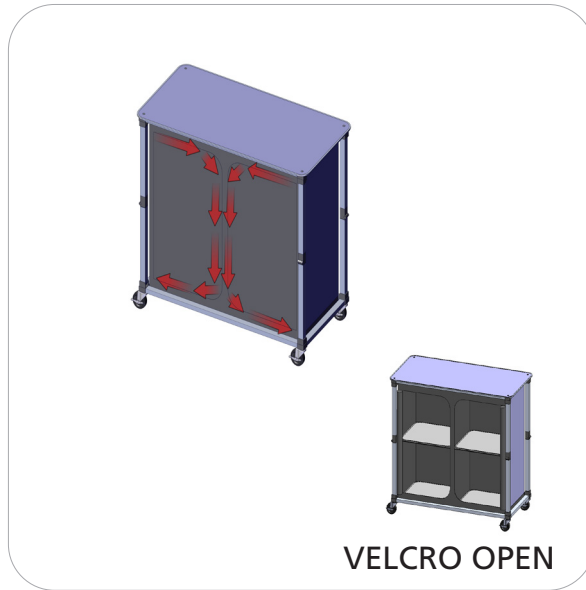
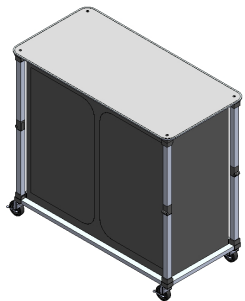

Step 4.

Apply graphics by pressing the sides of the graphics onto the counter, making sure the velcro bands are aligned with one another.

Set-up is complete

