

Funnel

Funnels transform any environment through form, fabric and lighting. Funnels feature a heavy-duty, wooden base and silver powder coated truss interior to create a dynamic, towering structure that commands attention. Fabric graphics feature a zipper at the top and a silicone edge at the bottom for easy assembly. Accent LED light kits are not included, but can be purchased a la carte to add a glow within the funnel structures.

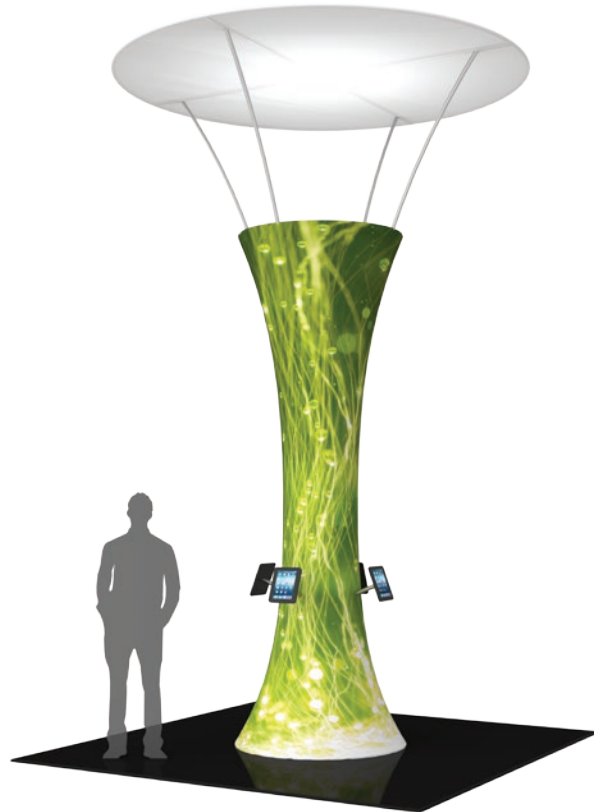

features and benefits:

- State-of-the-art 30mm curved aluminum tube frame with expanding spigots
- Easy to store and ship
- Quick to set up
- Kit includes: one frame, two dye-sublimated zipper pillowcase graphics, four iPad holders, and one OCE and one wheeled molded OCH2 storage case (base packs separately).
- Lifetime hardware warranty against manufacturer defects

dimensions:

Hardware	Graphic
<p>Assembled unit: 35.95" w x 144" h x 59.5" d 912mm(w) x 3657mm(h) x 1509mm(d)</p> <p>Approximate weight with cases: 249 lbs / 113kgs</p>	<p>Refer to related graphic template for more information.</p>
<p>Shipping</p> <p>Packing case(s): 1 OCE Case 1 OCH2 Case</p> <p>Shipping dimensions: OCE: Expandable case length (l) may vary 40" - 66" l x 18" w x 18" h 1016mm-1677mm(l) x 458mm(w) x 458mm(h)</p> <p>OCH2: 52" l x 29" w x 15" h 1321mm(l) x 737mm(w) x 381mm(h)</p> <p>Approximate total shipping weight (includes cases & graphics): 295 lbs / 134kgs</p>	
<h3>additional information:</h3> <p>Graphic material: dye-sublimation zipper pillowcase fabric</p> <p>*Tablet holders compatible with 2nd - 4th gen and Air iPad tablets only.</p> <p>*Tablets not included.</p>	

We are continually improving and modifying our product range and reserve the right to vary the specifications without prior notice. All dimensions and weights quoted are approximate and we accept no responsibility for variance. E&OE. See Graphic Templates for graphic bleed specifications.

Included In Your Kit

Tools, Components, & Connectors



ALLEN KEY SET x1



ES30 x38



FUN-HU-S x4

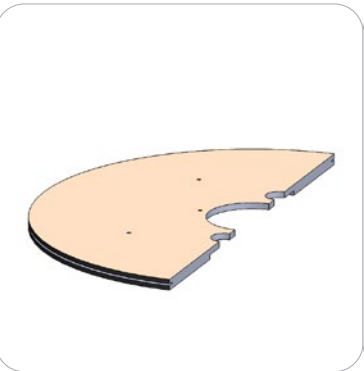

BASE-FUN-04-1 x2

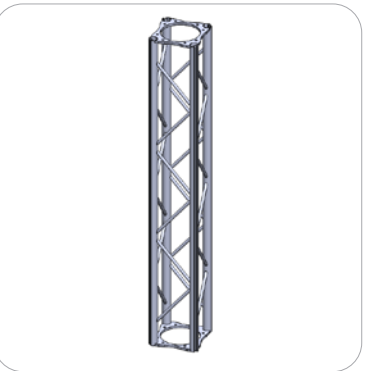

FUN-04-TRUSS-1 x2



FUN-04-TRUSS-2 x1

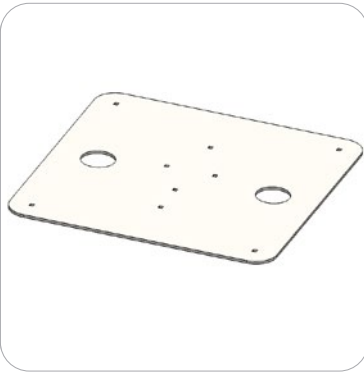

FUN-PLATE-ST x2



Wingnut x20



M8-1.25-30MM x16



M8-1.25-40MM x4

Graphics

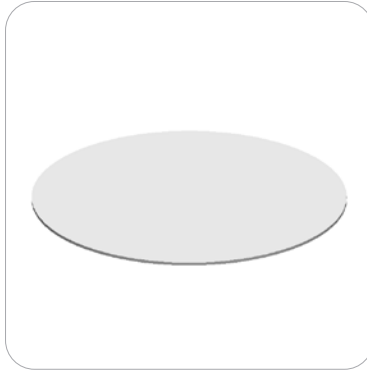

FUN-04-A-G x1

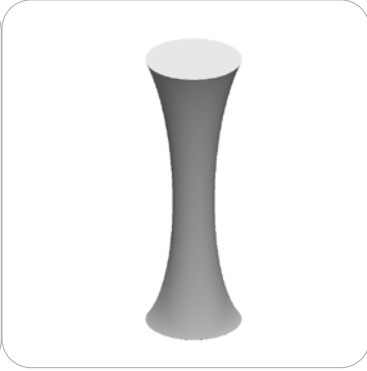

FUN-04-B-G x1



10MM ALLEN KEY x1

Included In Your Kit

Tubes



FUN-04-T1 x1



FUN-04-T2 x4



FUN-04-T3 x2



FUN-04-T4 x4



FUN-04-T5 x4

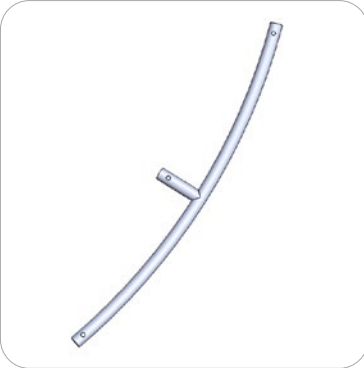

FUN-04-T6 x4



FUN-04-T7 x4



FUN-04-T8 x1

Exploded View

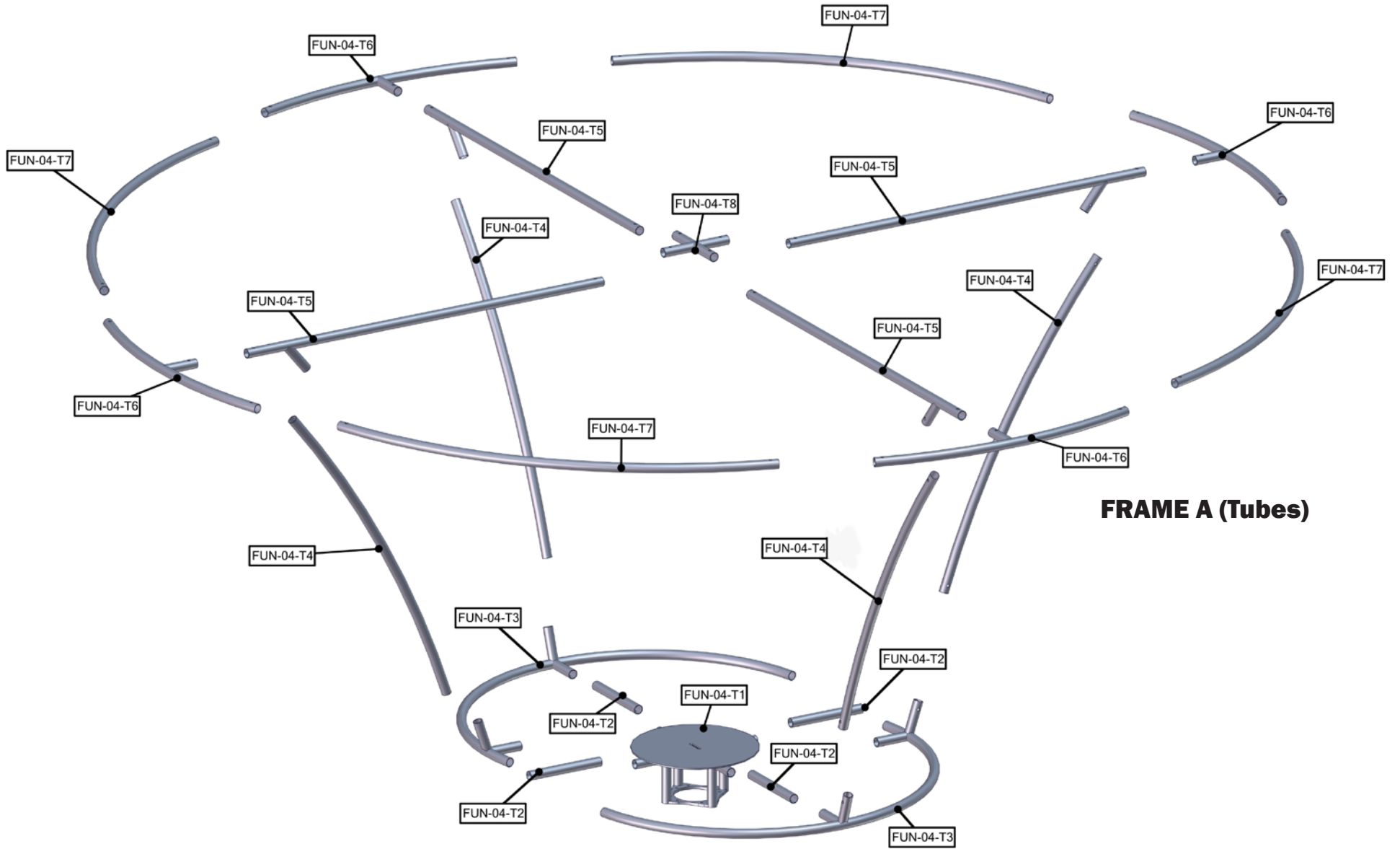

FRAME A (Tubes)

Exploded View

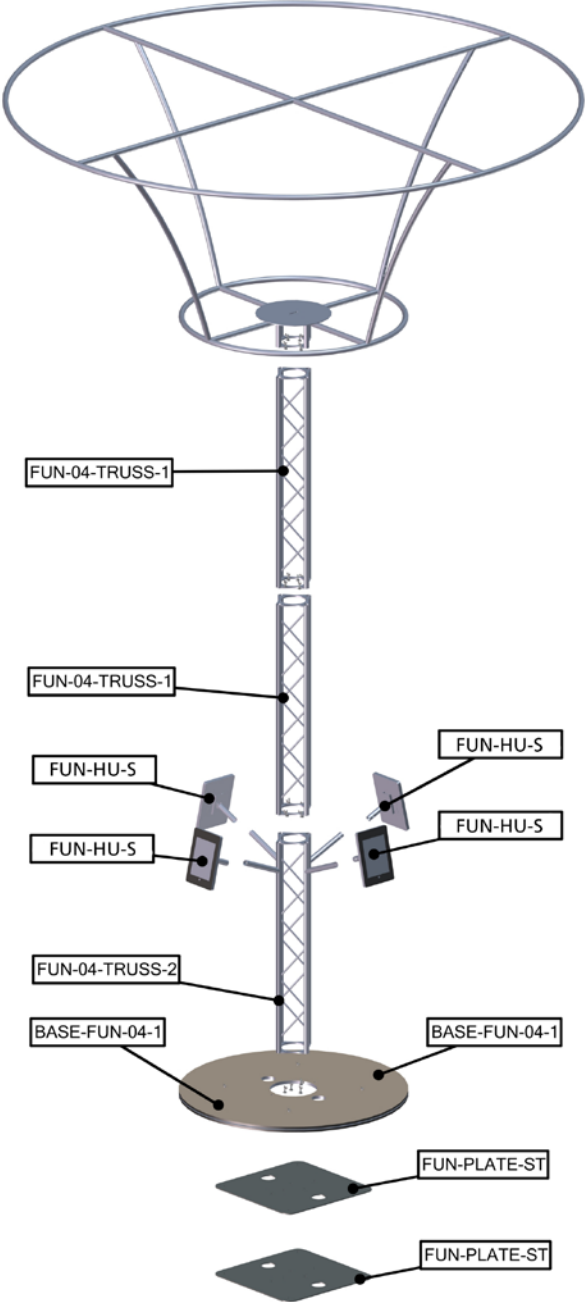

FRAME A (Truss)

Labeling Diagram

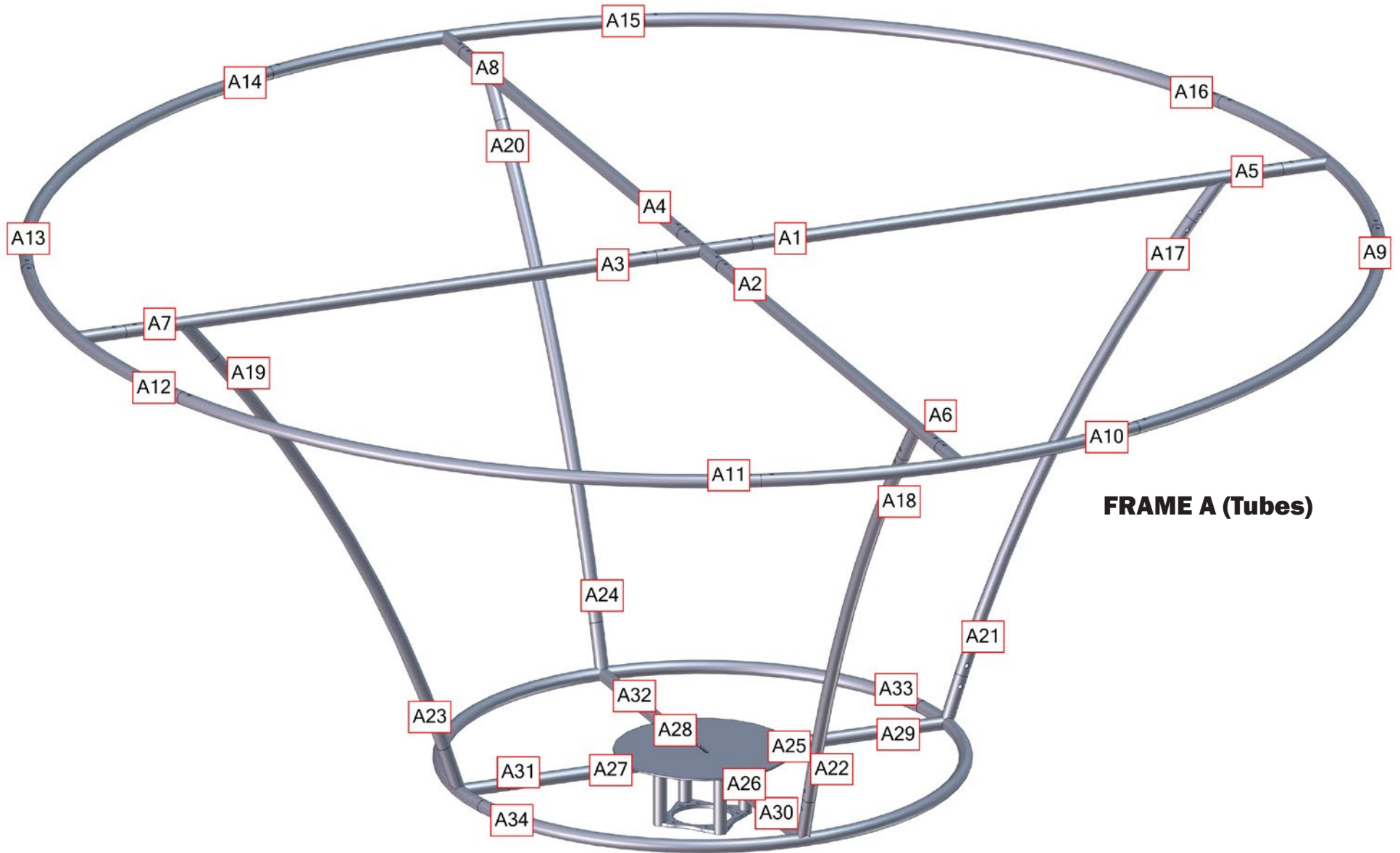

FRAME A (Tubes)

Connection Methods

Formulate® structures use a number of different yet simple connection methods. Your kit will include one or more of the connection methods shown below. Steps within the Kit Assembly will reference a specific method for each connection point.

Connection Method 1: ES30 / ES50 / ES75

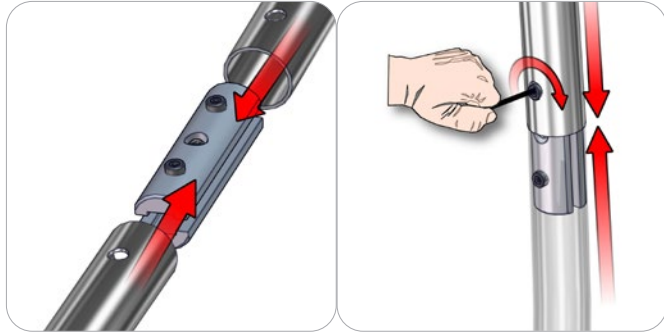

Compress the unlocked connector and slide one tube onto each end. Lock both screws carefully using your allen key tool. Be sure to lock securely, but do not overtighten.

Connection Method 2: Snap Buttons & Swage

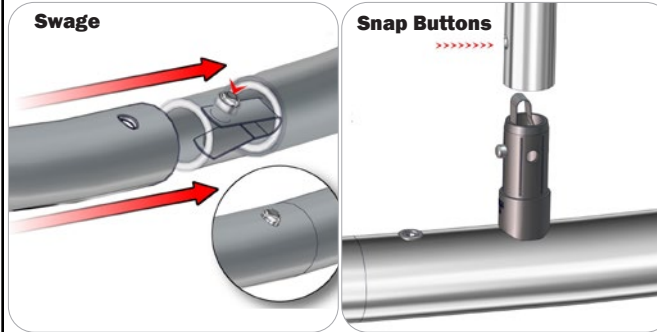

Locate the snap button on the connector or swage tube. Locate the hole on the corresponding tube. Press the snap button with your thumb and slide the tube and connector together so that the snap button snaps fully into the lock hole. To disassemble, press the snap button and pull apart.

Connection Method 3: ES30-90B / ES30-I / ES30-C

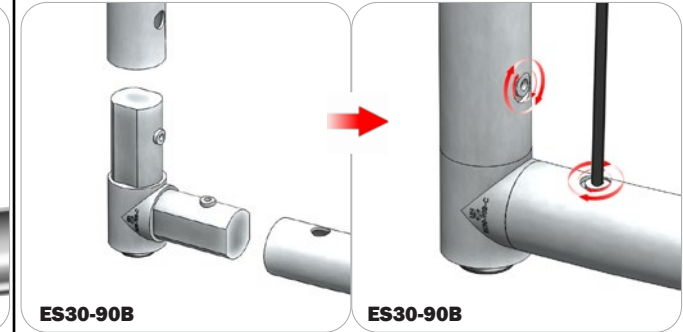

Compress one unlocked end of the connector and slide it through one tube end. Compress the other end of the connector and slide the second tube on. Lock both screws carefully using your allen key tool. Be sure to lock securely, but do not overtighten.

Connection Method 4: Tube Clamps

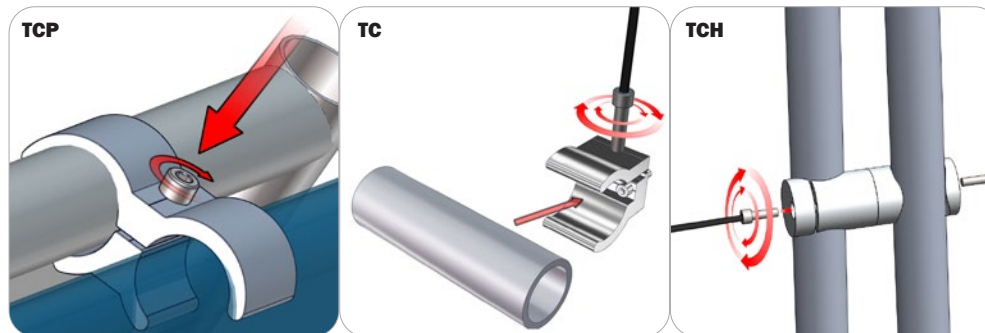

Be sure to fully assemble all frames before using clamps. With the clamp unlocked, place one tube of the first frame into the mouth of the clamp. Place the second tube (if applicable) into the second mouth of the clamp. With both frame's tubes in the clamp, be sure to lock securely, but do not overtighten.

Kit Assembly

Step by Step

Step 1.

Assemble your tube structure according to the Labeling Diagram. Skip connections 17-24 (FUN-04-T4), we will connect these tubes in a later step.

Please reference Connection Method 1 for more details.



Step 2.

Apply FUN-04-A-G to the top portion of your tube structure using the zippers.

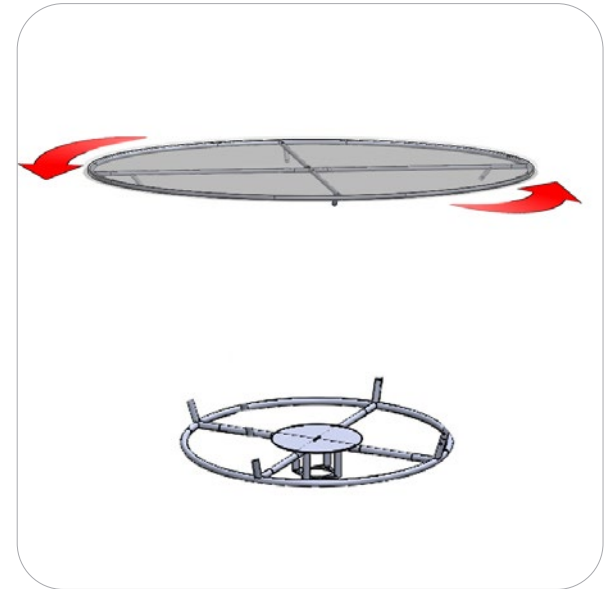

Step 3.

Locate your (2) BASE-FUN-04-1. Use the 8mm allen key to lock the bases together.

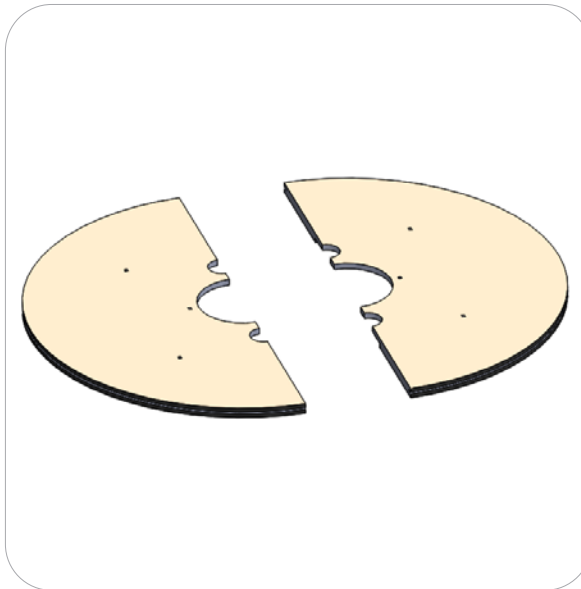
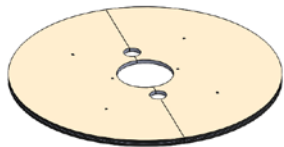

Step 4.

Locate the (2) FUN-PLATE-ST. Stack the plates into the routed underside of the base. Fasten the plates to the base using (4) M8-1.25-40MM carriage bolts and (4) Wingnuts. Thread the screws through the bottom of the base and use wingnuts to secure from the top.

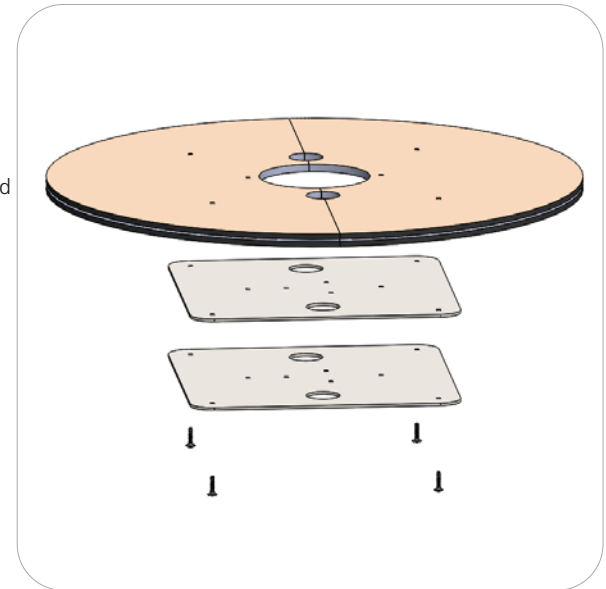
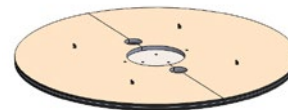

Kit Assembly

Step by Step

Step 5.

Attach your FUN-04-TRUSS-2 truss assembly to the base using (4) M8-1.25-30MM bolts and (4) Wingnuts. Thread the screws through the bottom and secure with wingnuts from the top. Add your FUN-04-B-G graphic over the truss and fit the bottom into the routing along the base.

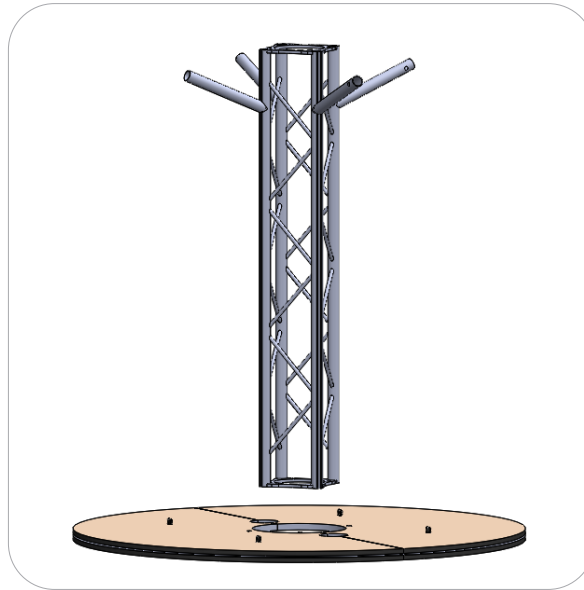

Step 6.

Attach (1) truss assembly to the top of your FUN-04-TRUSS-2. Use (4) M8-1.25-30MM bolts and (4) Wingnuts. Thread the screws through the bottom and secure with wingnuts from the top.

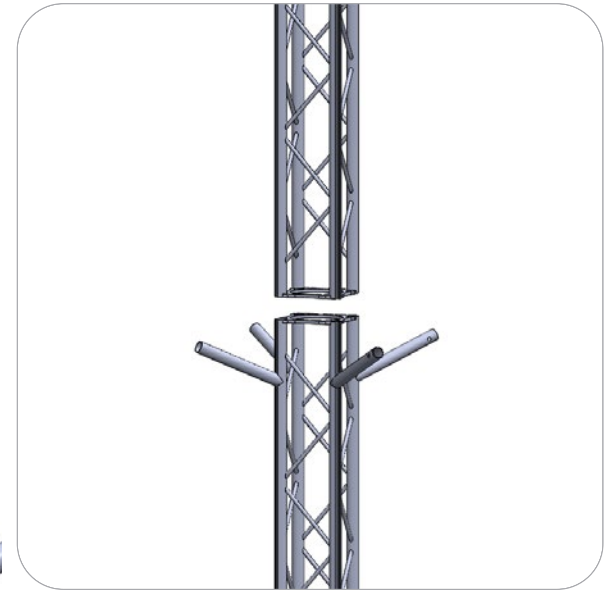
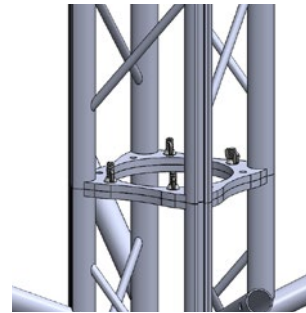

Step 7.

Attach the final (1) FUN-04-TRUSS-1 truss assembly to the top of your attached FUN-04-TRUSS-1. Use (4) M8-1.25-30MM bolts and (4) Wingnuts. Thread the screws through the bottom and secure with wingnuts from the top.

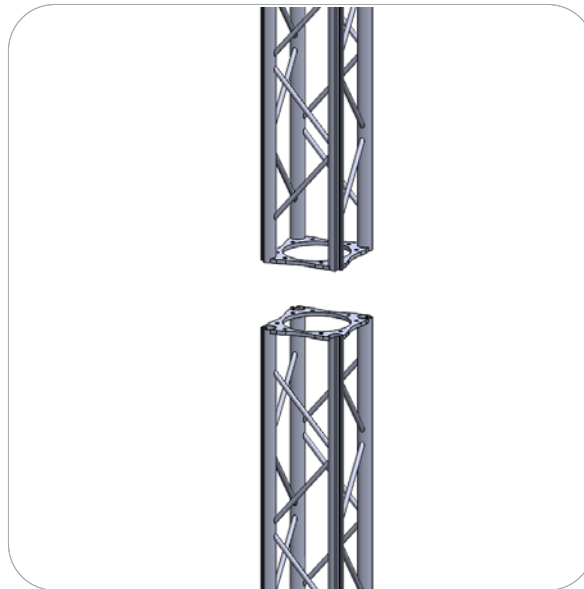

Step 8.

Locate the lower portion of your tube assembly. Use (4) M8-1.25-30MM bolts and (4) Wingnuts to lock the bottom of your tube assembly to the top of the FUN-04-TRUSS-1. Thread the screws through the bottom and secure with wingnuts from the top. Pull your FUN-04-B-G graphic up to the top of your assembly. Zip the fabric around the tube structure. Pushfit the bottom of the pillowcase into the base. Be sure to allow the arms on the truss protrude through the graphic without twisting or distorting the graphic, adjust if needed.



Kit Assembly

Step by Step

Step 9.

Apply your FUN-04-T4 tubes to your tube structure using ES30s.

Please reference Connection Method 1 for more details.

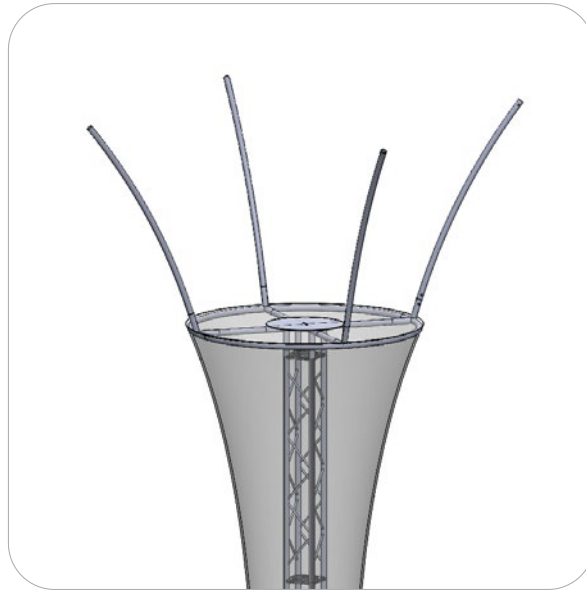

Step 10.

Apply the top portion of your tube structure.

Please reference Connection Method 1 for more details.



Step 11.

Locate your (4) IPAD-HU-S. Attach them to your protruding truss arms using (4) ES30 spigots.

Please reference Connection Method 1 for more details.

