

# Light Box With Bridge Header Instructions

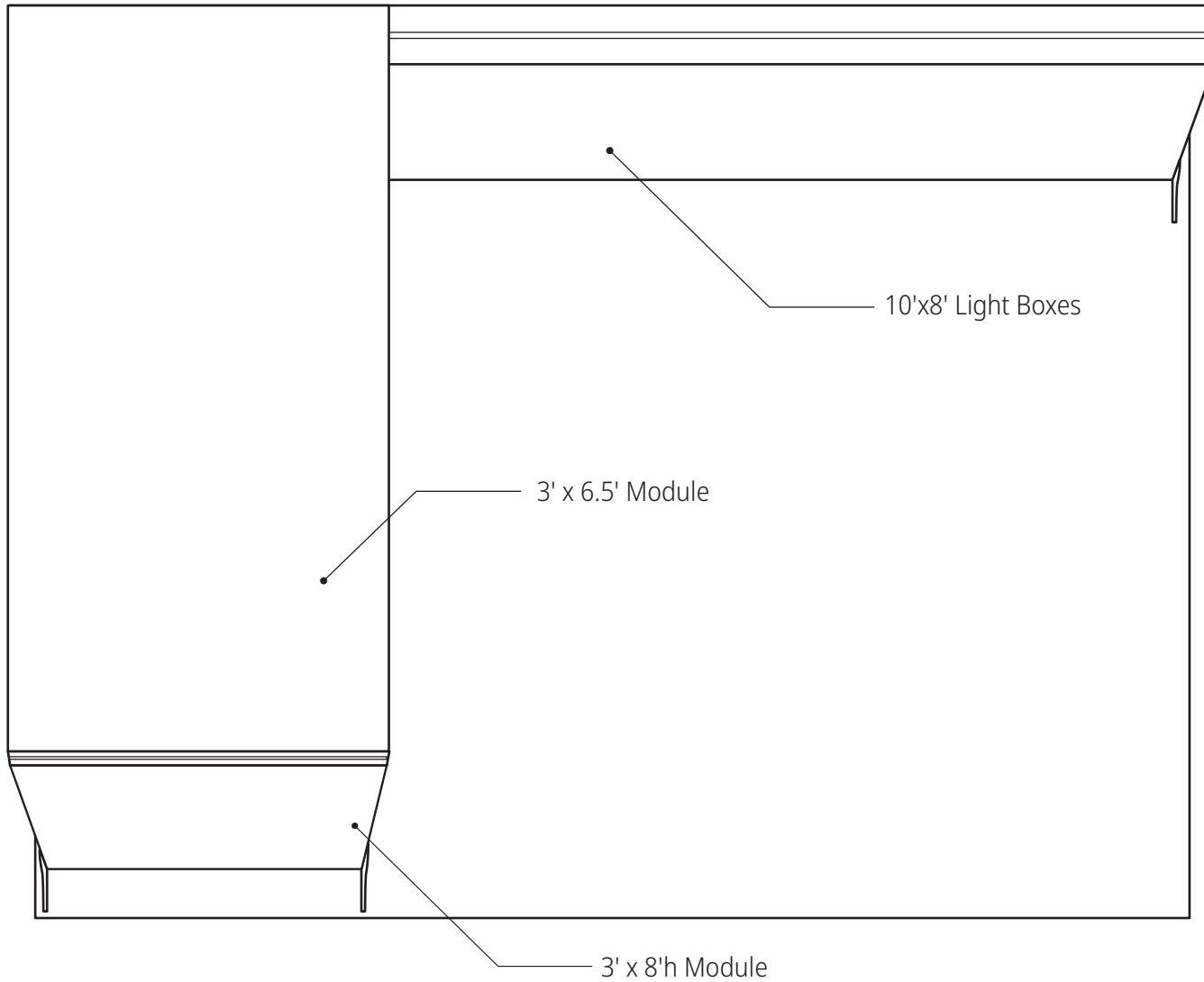

# Plan Preview



# 3'x8' Module Assembly

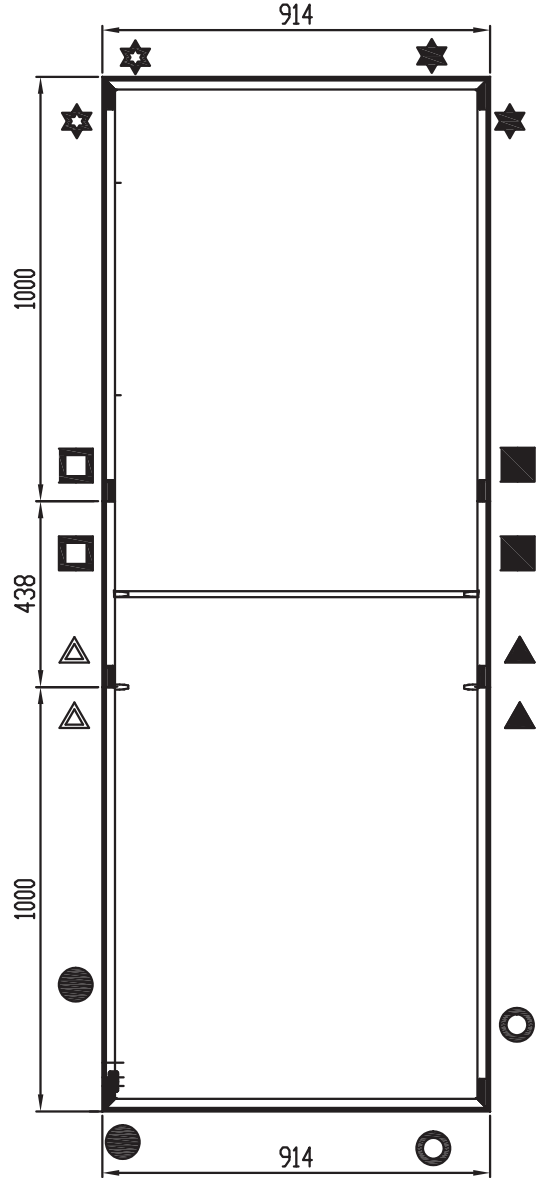

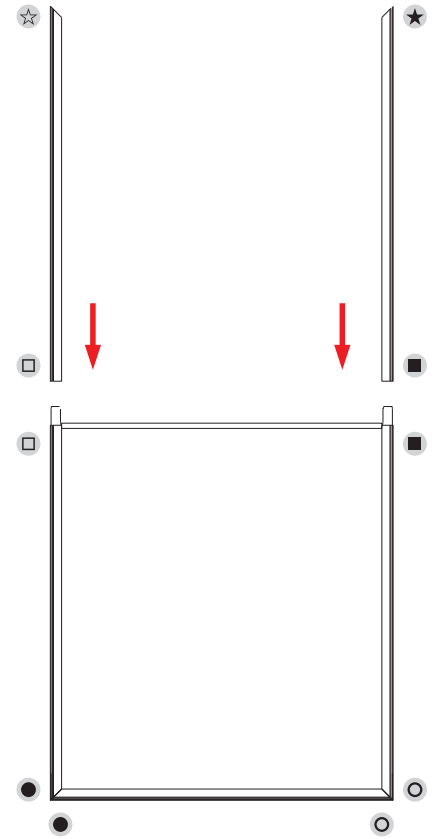
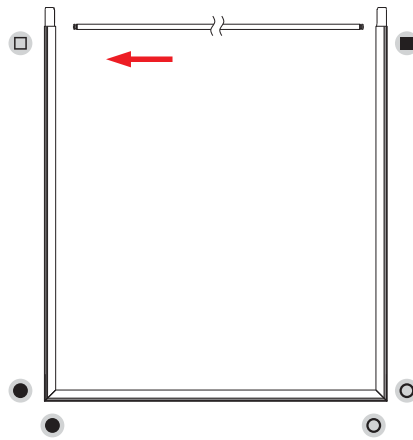
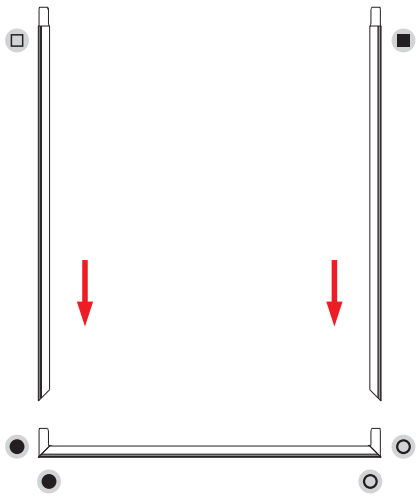
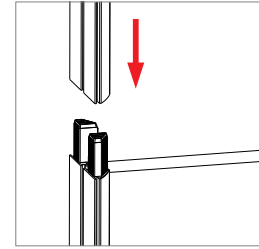
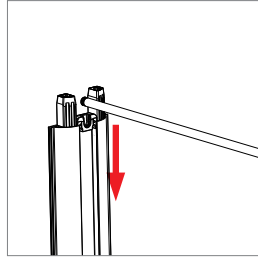
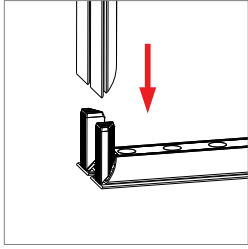

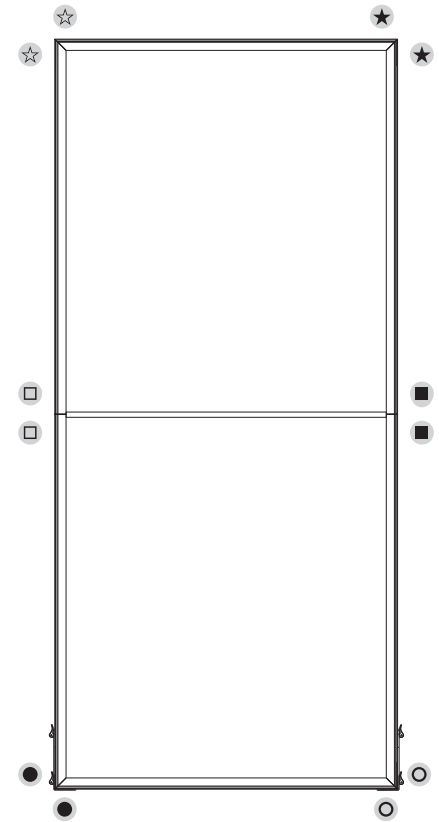
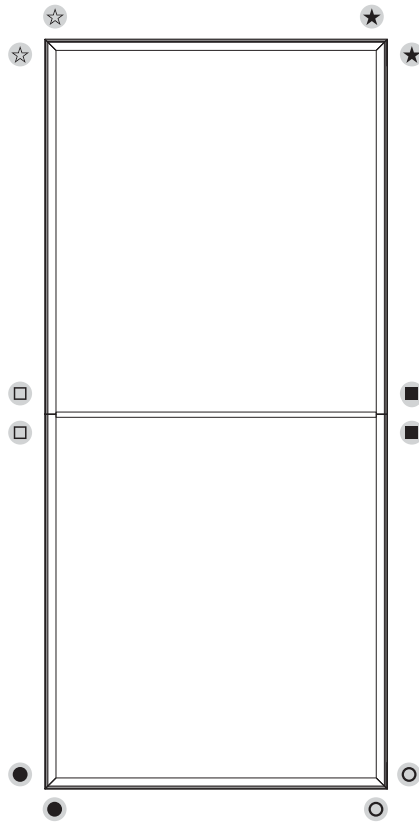
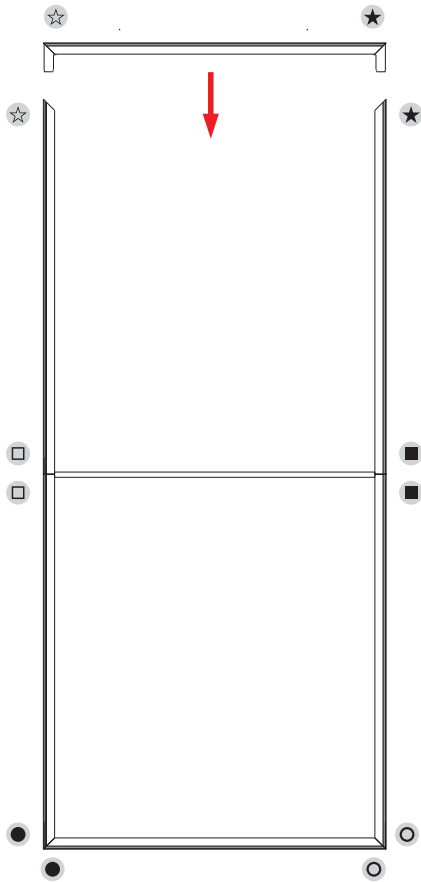
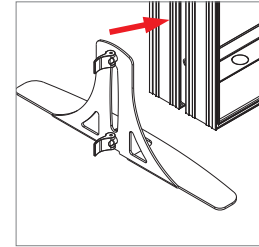
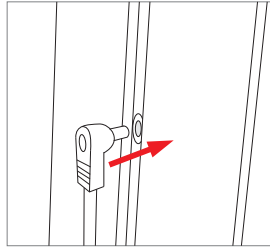
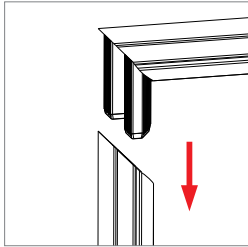

# 10'x8' Light Box Assembly

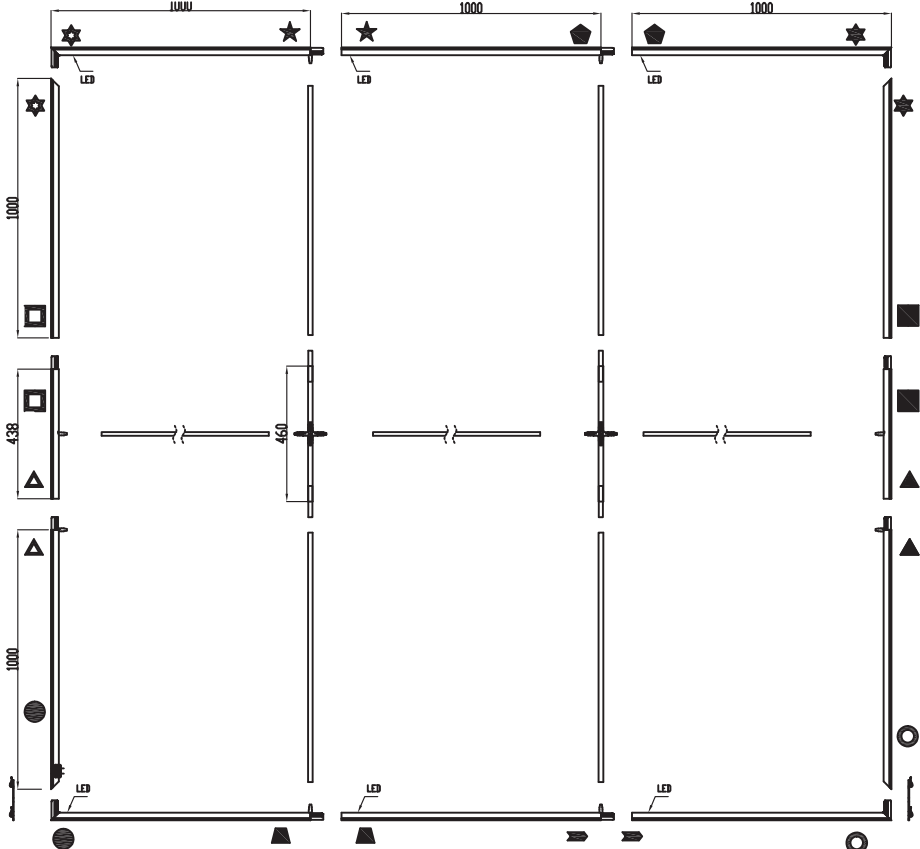

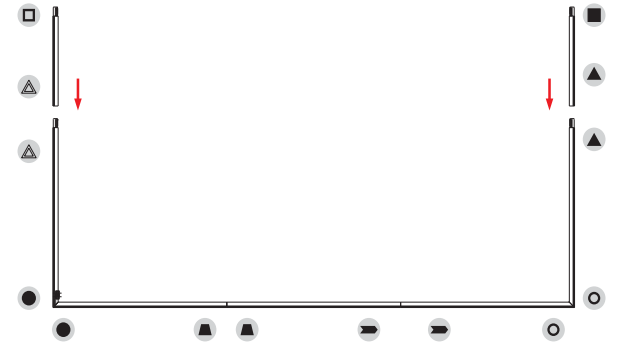
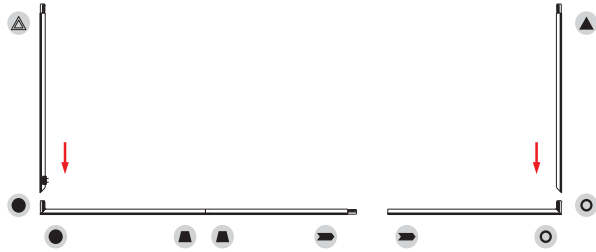
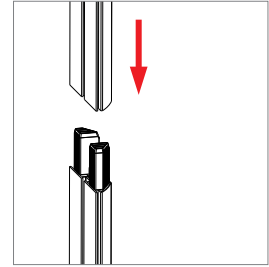
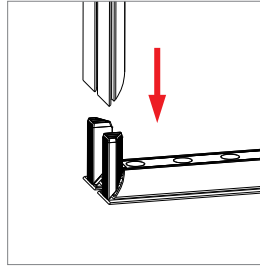
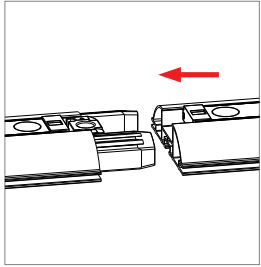

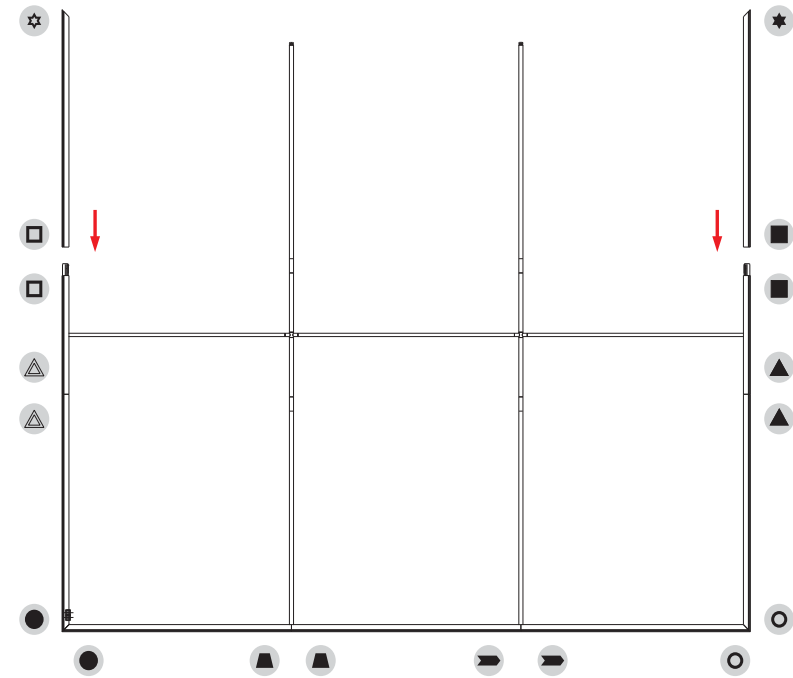
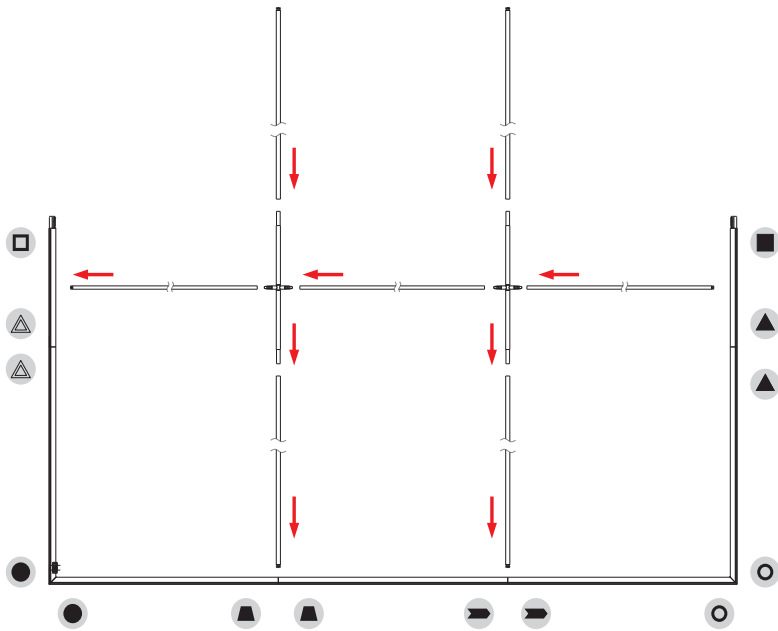
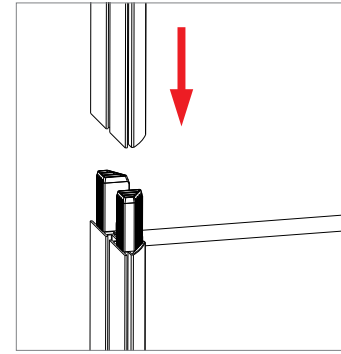
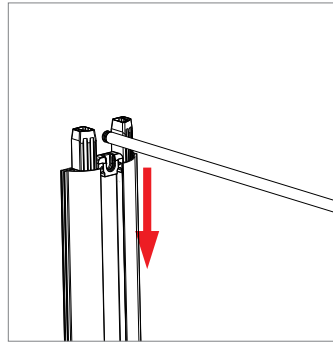
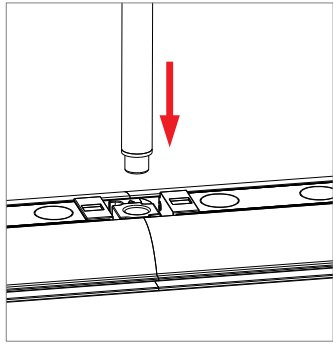



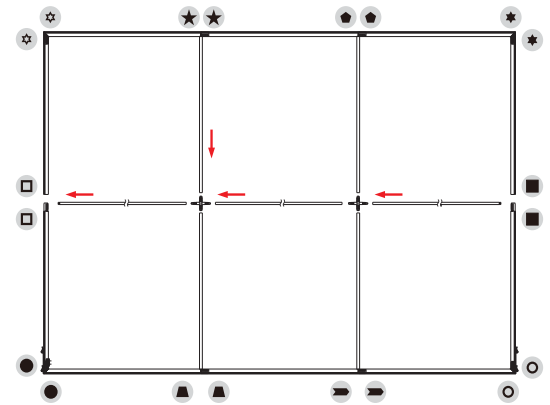
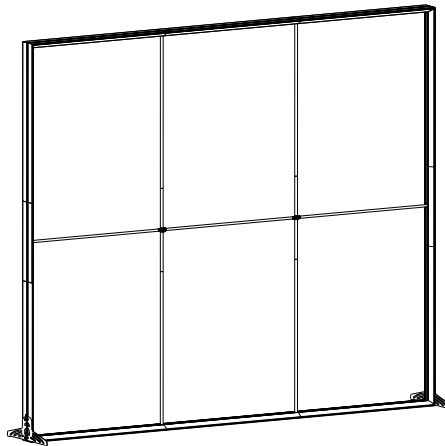
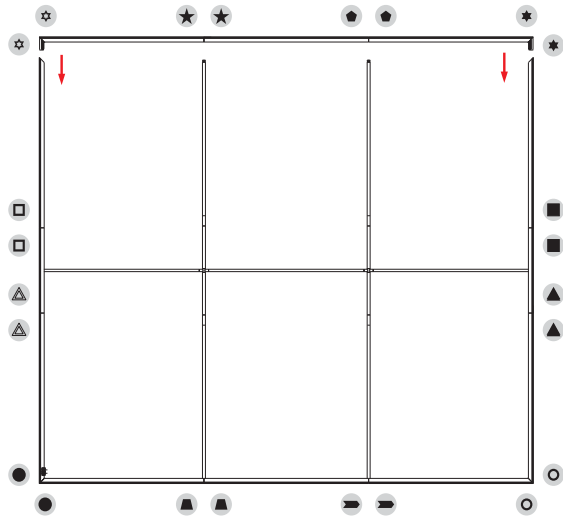
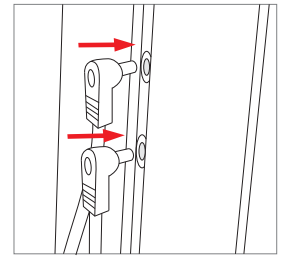
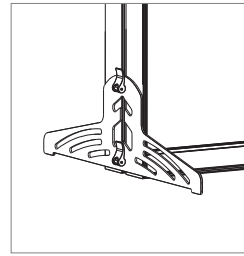
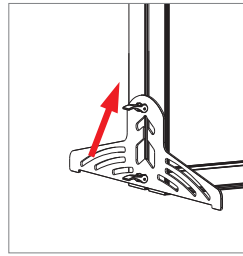
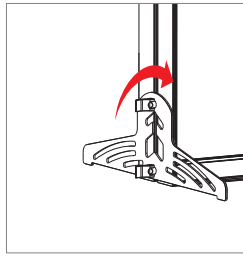
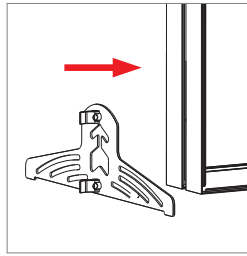
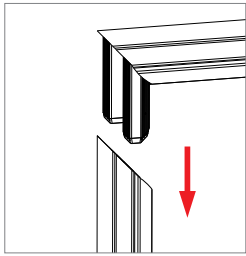

# 3'x6.5' Module Assembly

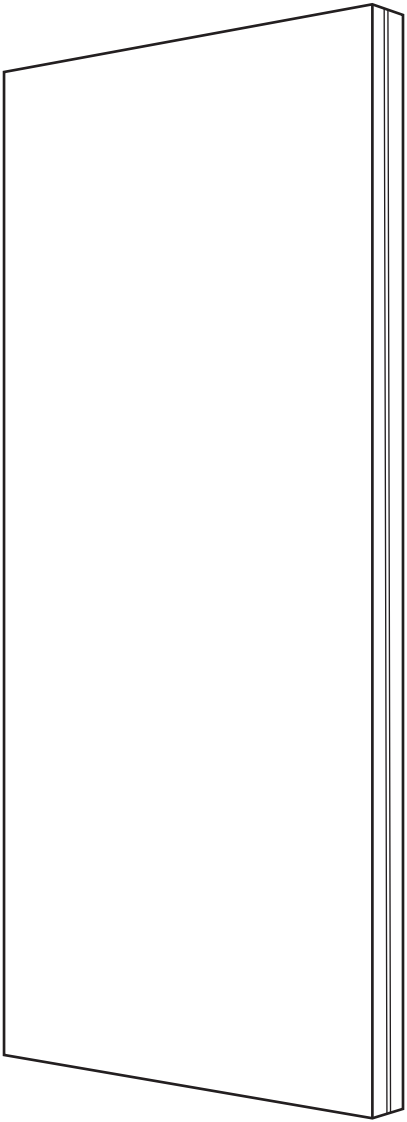
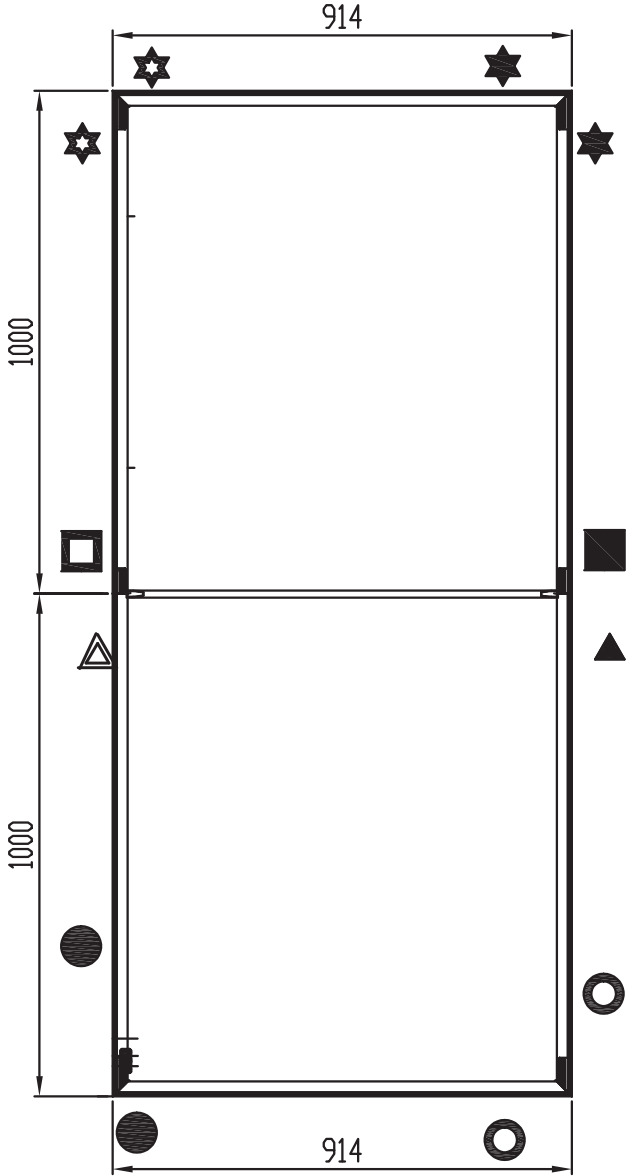

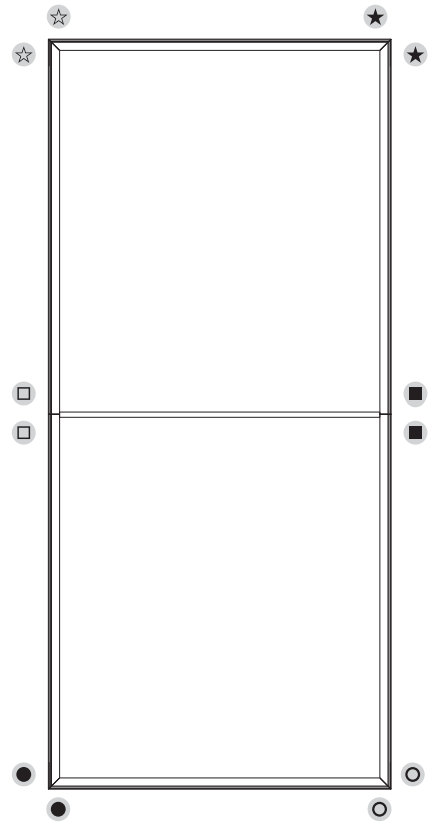
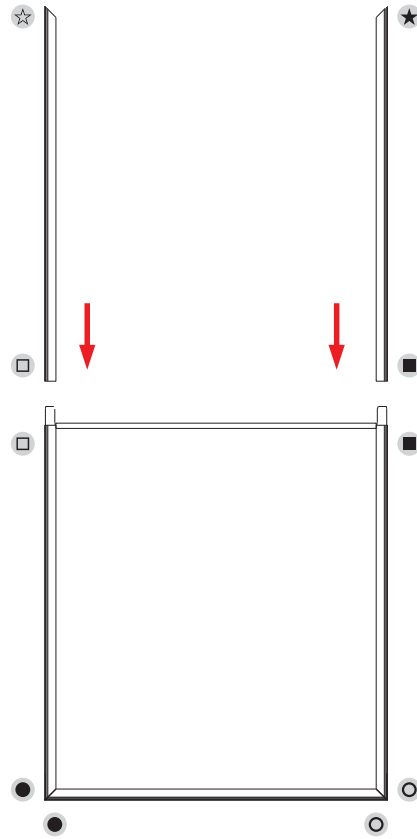
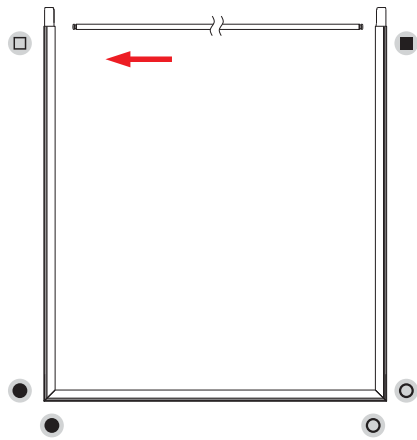
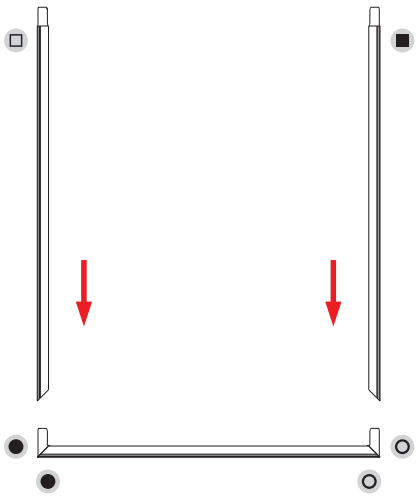
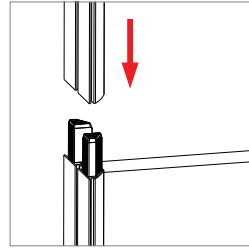
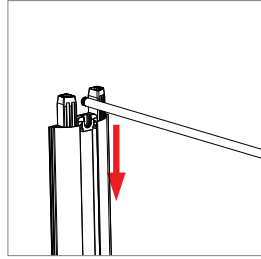
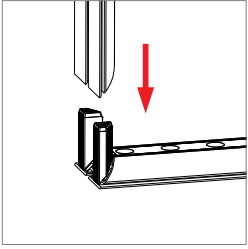

# T connector Assembly

