

BrightLine

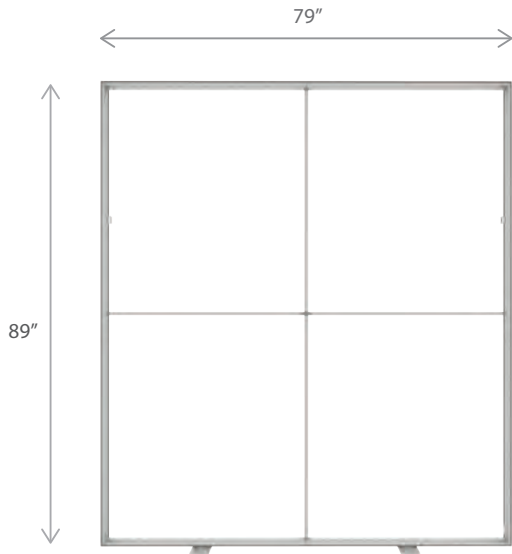

PRODUCT DESCRIPTION

BrightLine smart light box displays feature swift tool-free installation, durable light-weight frames, embedded LEDs, and exclusive One Planet recycled fabrics with impressive vivid graphics, all conveniently organized in a heavy-duty shipping case. Panel N backlit display is two meters of brilliance, perfectly sized to create high-impact 20ft booths in just three panels.

Mix-and-match with other BrightLine panels, or combine with WaveLine and SharpLine displays, to create unique branded environments. TV mounts and counters complete an enhanced experience to really make brands stand out.

KEY FEATURES

- Easy tool free assembly
- Lightweight portable construction
- Magnetic power links
- LED lights encapsulated in frame
- Heavy duty shipping case, molded foam inserts
- Single- or double-sided
- Vibrant graphics on recycled fabric

DISPLAY CONSTRUCTION

Aluminum frame with aluminum support poles

DIMENSIONS

Assembled Unit	79"w x 89"h x 4"d
Packed Case	46.5"w x 15"h x 12"d, 58 lbs
Shipping Box	47"w x 16"h x 13"d, 60 lbs
Graphic Size	79"w x 89"h

GRAPHIC MATERIAL

Graphic Print : Dye sublimated on One Planet, 100% recycled, backlit fabric	Bottles recycled 51
Blocker : One Planet light block recycled fabric	Bottles recycled 20

LED LIGHT SPECIFICATIONS

Power Requirements	128 W
CCT (Color Temp)	6000 K
Voltage Input	110 / 220V
Voltage Output	24V 11A 264W
Transformers Included	1

GRAPHIC FINISHING

Silicone sewn edges

WARRANTY

Limited Warranty Periods

- Frame : Lifetime
- Lights : 90 days
- Graphics : 30 days

ASSEMBLY

Assemble parts on the floor and stand-up unit when completed.

1



2

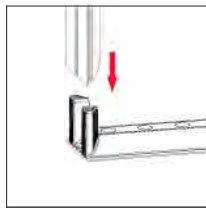

3

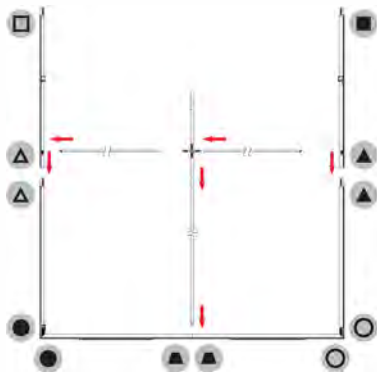
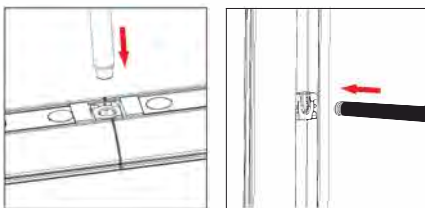

4

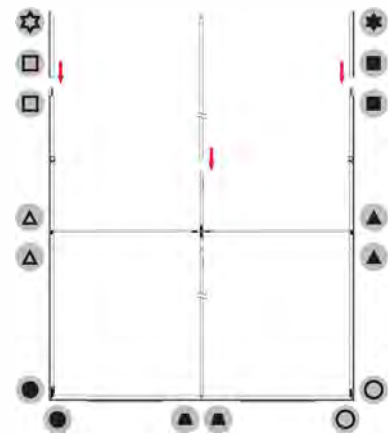
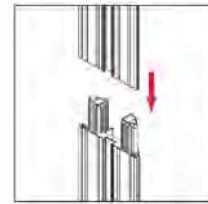

5

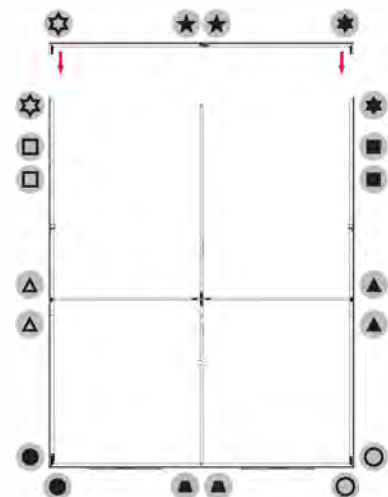

6 Push the silicone bead into each corner of the frame with your thumb.

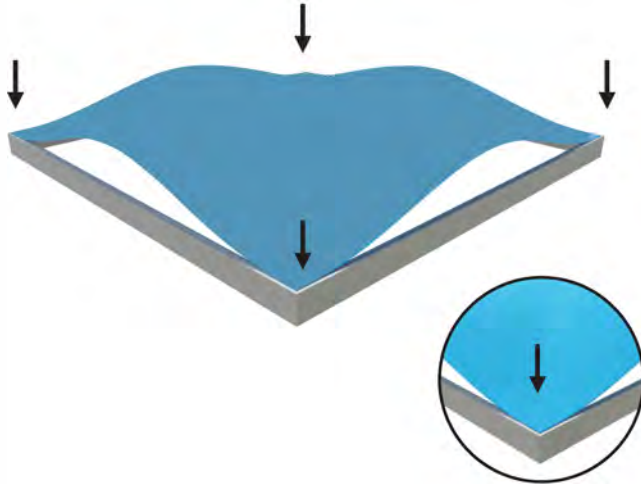

Push the silicone bead into the middle of the run and work your way around the perimeter of the frame until all beading is pushed in properly

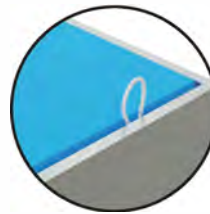
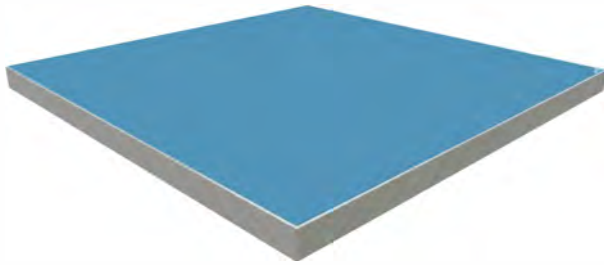
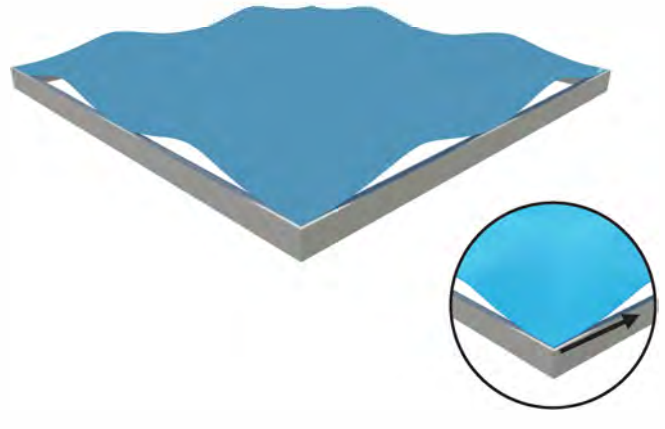

To Remove Graphic
Use the pull tab located on the graphic and gently pull the graphic from the frame, going around the perimeter

7

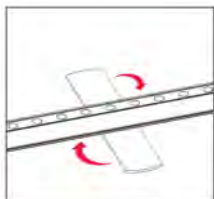
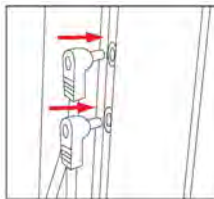

BrightLine

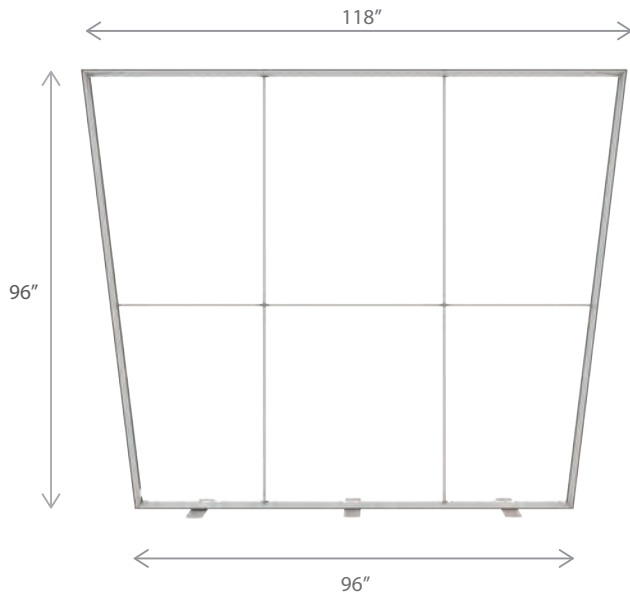

PRODUCT DESCRIPTION

BrightLine smart light box displays feature swift tool-free installation, durable light-weight frames, embedded LEDs, and exclusive One Planet recycled fabrics with impressive vivid graphics, all conveniently organized in a heavy-duty shipping case. Panel A2, an illuminated trapezoid backdrop, showcases a distinctive shape and style guaranteed to turn heads at any event.

Mix-and-match with other BrightLine panels, or combine with WaveLine and SharpLine displays, to create unique branded environments. TV mounts and counters complete an enhanced experience to really make brands stand out.

KEY FEATURES

- Easy tool free assembly
- Lightweight portable construction
- Magnetic power links
- LED lights encapsulated in frame
- Heavy duty shipping case, molded foam inserts
- Single- or double-sided
- Vibrant graphics on recycled fabric

DISPLAY CONSTRUCTION

Aluminum frame with aluminum support poles

DIMENSIONS

Assembled Unit	118"w1 x 96"w2 x 96"h x 4"d
Packed Case	46.5"w x 15"h x 12"d, 71 lbs
Shipping Box	47"w x 16"h x 13"d, 73 lbs
Graphic Size	118"w x 96"h1 x 96"h2

GRAPHIC MATERIAL

Graphic Print : Dye sublimated on One Planet, 100% recycled, backlit fabric	Bottles recycled 82
Blocker : One Planet light block recycled fabric	Bottles recycled 33

LED LIGHT SPECIFICATIONS

Power Requirements	172 W
CCT (Color Temp)	6000 K
Voltage Input	110 / 220V
Voltage Output	24V 11A 264W
Transformers Included	1

GRAPHIC FINISHING

Silicone sewn edges

WARRANTY

Limited Warranty Periods

- Frame : Lifetime
- Lights : 90 days
- Graphics : 30 days

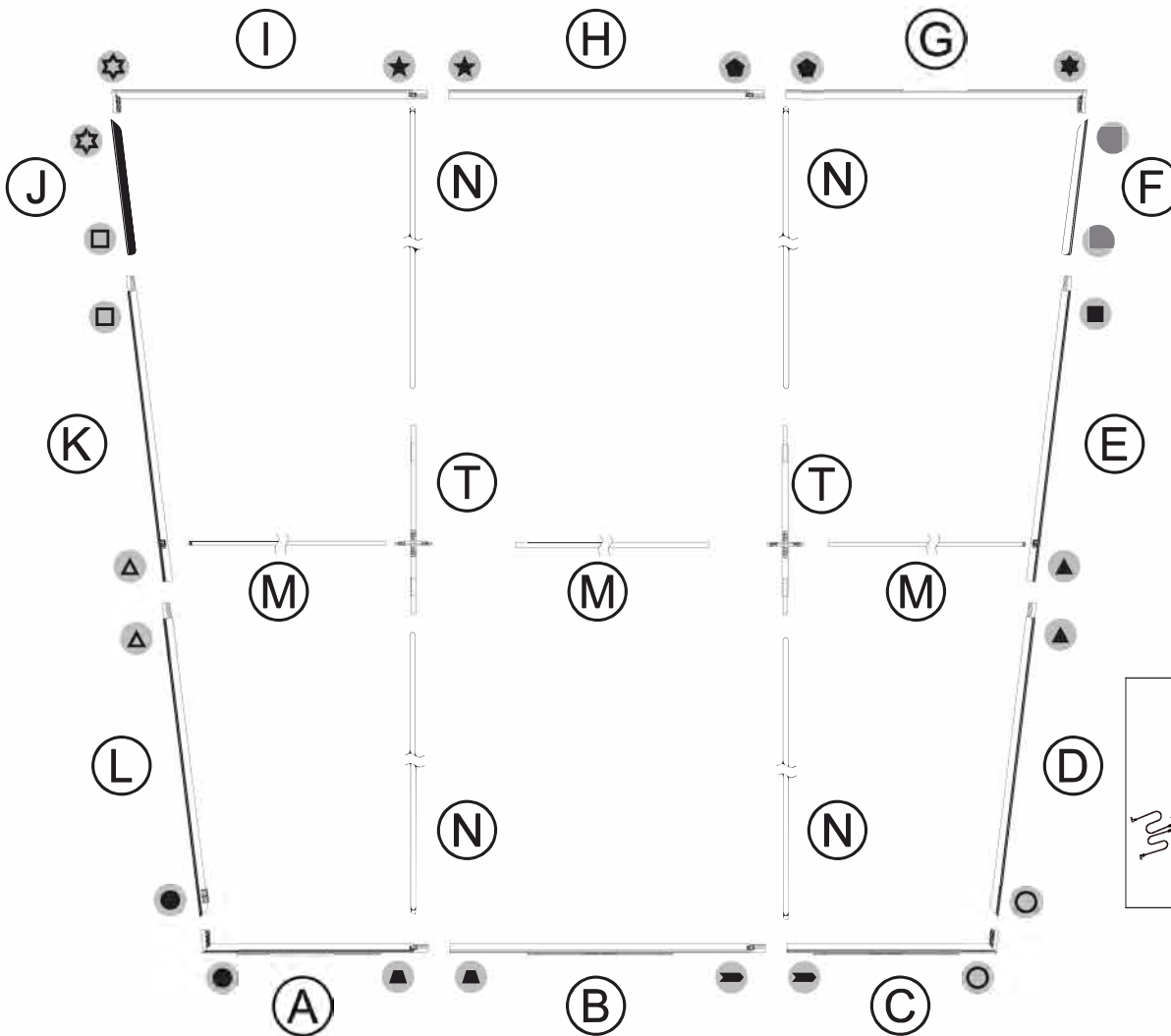

ASSEMBLY

Assemble parts on the floor and stand-up unit when completed.

1

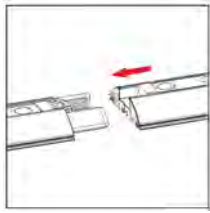

2



3

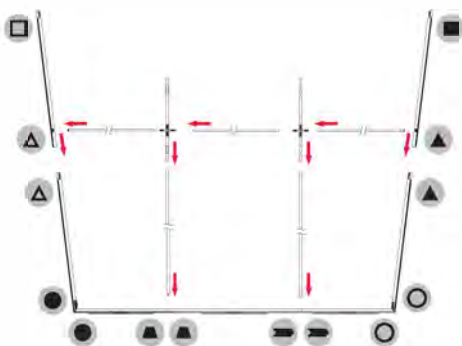
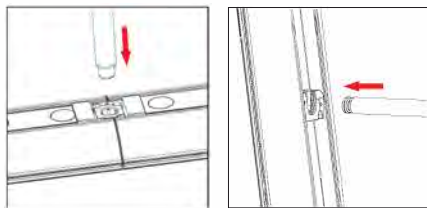

4

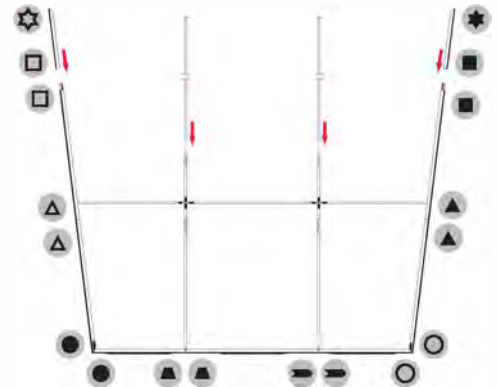
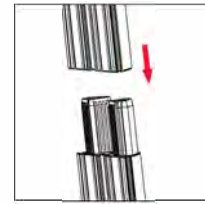

5

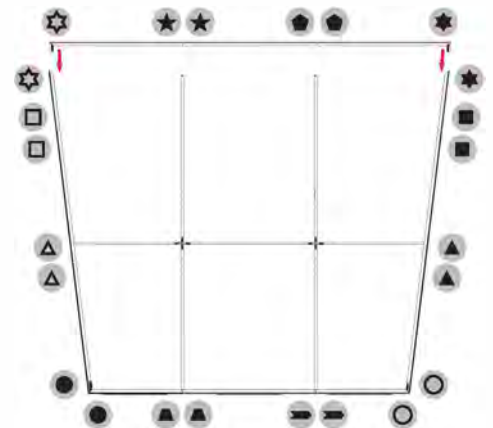
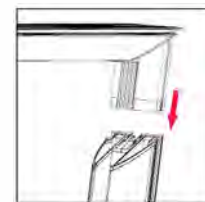

- 6 Push the silicone bead into each corner of the frame with your thumb.

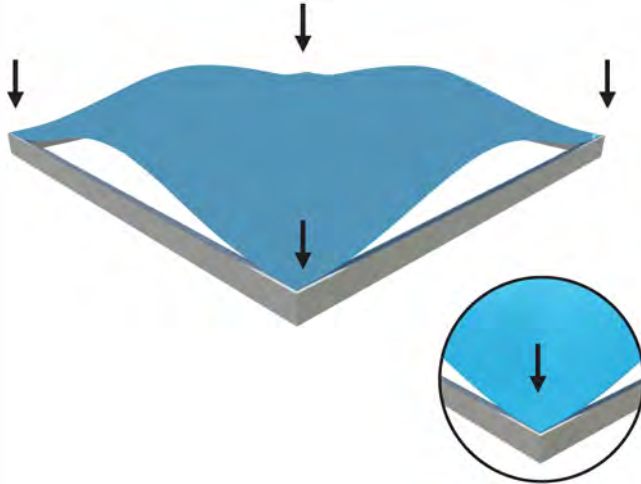

Push the silicone bead into the middle of the run and work your way around the perimeter of the frame until all beading is pushed in properly

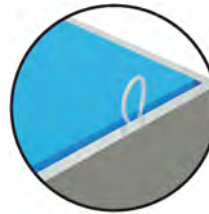
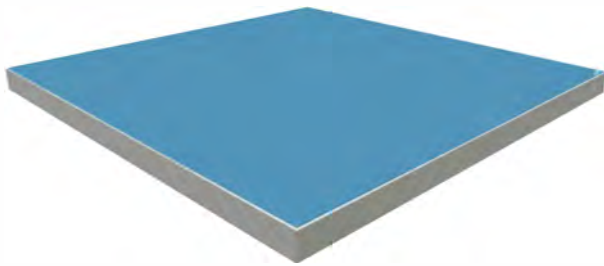
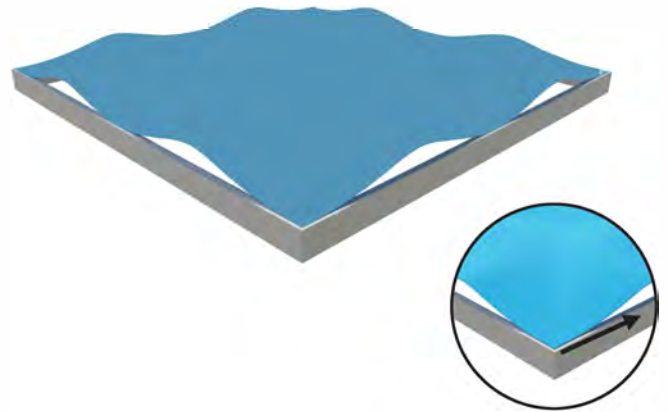

To Remove Graphic
Use the pull tab located on the graphic and gently pull the graphic from the frame, going around the perimeter

- 7

