

# BrightLine

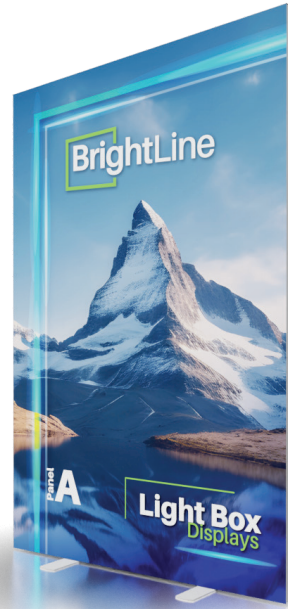
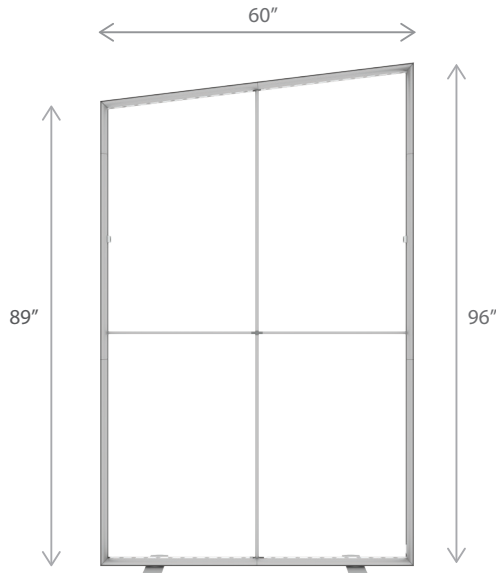

## PRODUCT DESCRIPTION

BrightLine smart light box displays feature swift tool-free installation, durable light-weight frames, embedded LEDs, and exclusive One Planet recycled fabrics with impressive vivid graphics, all conveniently organized in a heavy-duty shipping case. Panel A showcases a radiant angled design, engaging as standalone banner, but also very effective as a striking accent in combination with other panels.

Mix-and-match with BrightLine panels, or combine with WaveLine and SharpLine displays, to create unique branded environments. TV mounts and counters complete an enhanced experience to really make brands stand out.

## KEY FEATURES

- Easy tool free assembly
- Lightweight portable construction
- Magnetic power links
- LED lights encapsulated in frame
- Heavy duty shipping case, molded foam inserts
- Single- or double-sided
- Vibrant graphics on recycled fabric

## DISPLAY CONSTRUCTION

Aluminum frame with aluminum support poles

## DIMENSIONS

Assembled Unit	60"w x 89"h1 x 96"h2 x 4"d
Packed Case	46.5"w x 15"h x 12"d, 53 lbs
Shipping Box	47"w x 16"h x 13"d, 55 lbs
Graphic Size	60"w x 89"h1 x 96"h2

## GRAPHIC MATERIAL

Graphic Print : Dye sublimated on One Planet, 100% recycled, backlit fabric	Bottles recycled <b>42</b>
Blocker : One Planet light block recycled fabric	Bottles recycled <b>17</b>

## LED LIGHT SPECIFICATIONS

Power Requirements	112 W
CCT (Color Temp)	6000 K
Voltage Input	110 / 220V
Voltage Output	24V    11A    264W
Transformers Included	1

## GRAPHIC FINISHING

Silicone sewn edges

## WARRANTY

Limited Warranty Periods

- Frame : Lifetime
- Lights : 90 days
- Graphics : 30 days

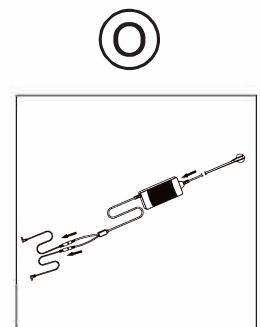
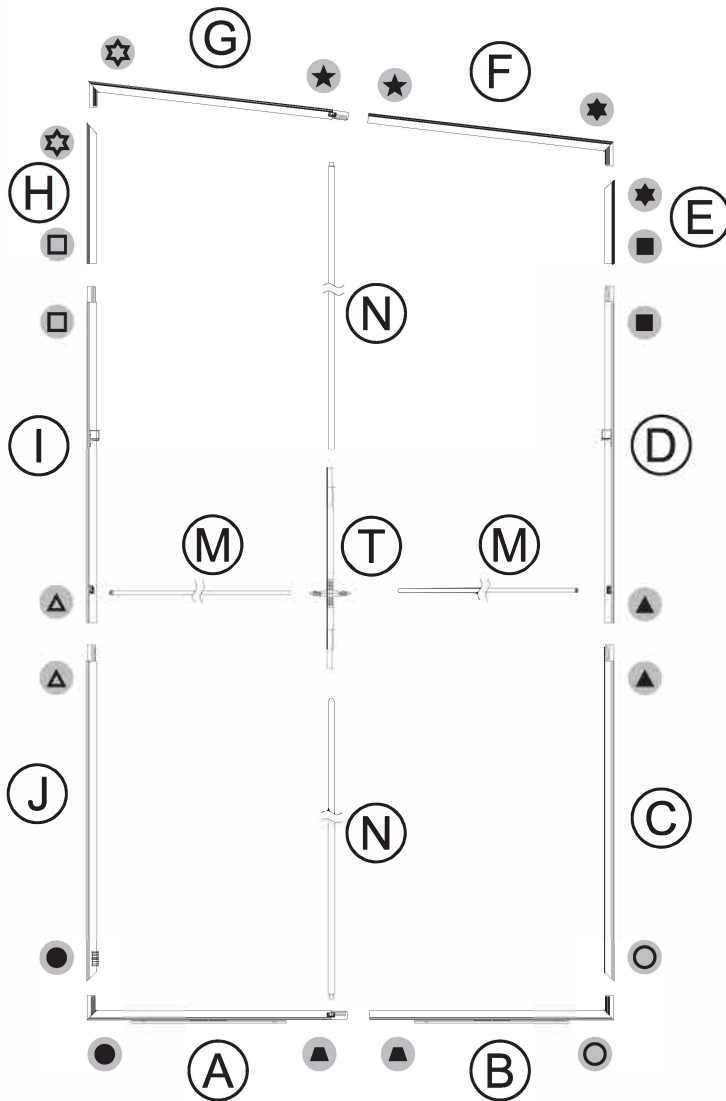
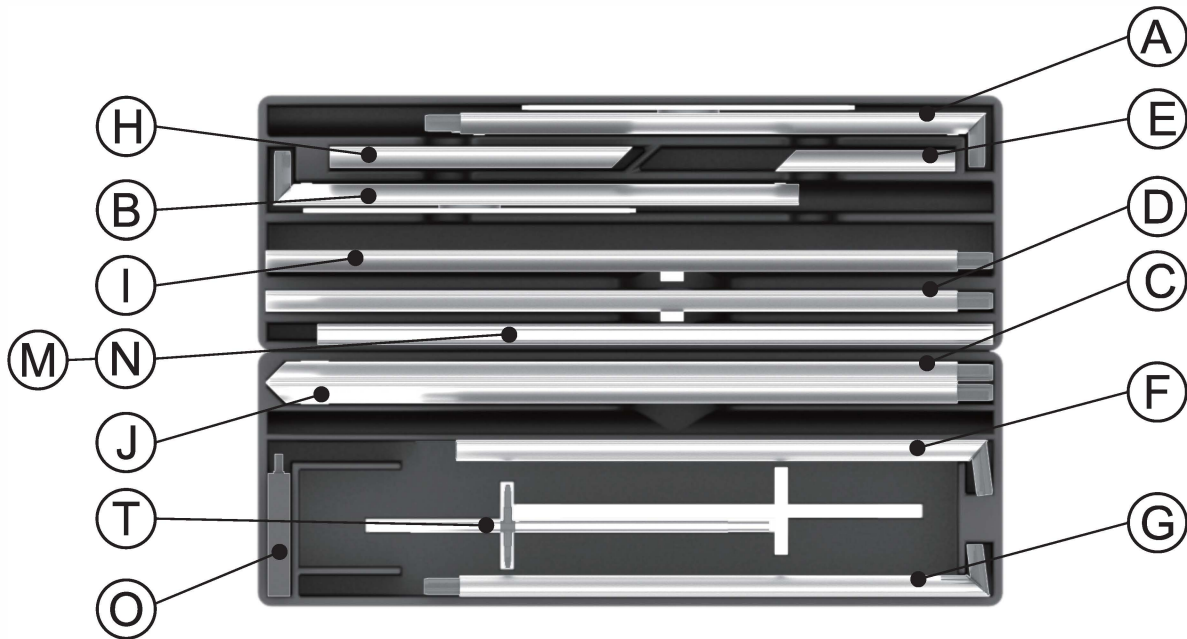

Assemble parts on the floor and stand-up unit when completed.

1

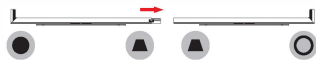
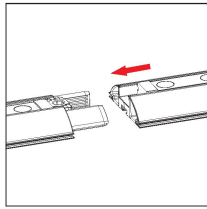

2

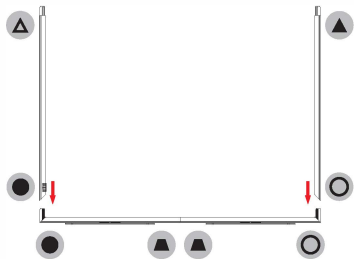
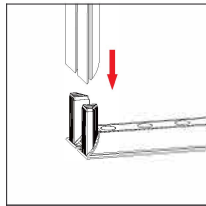

3

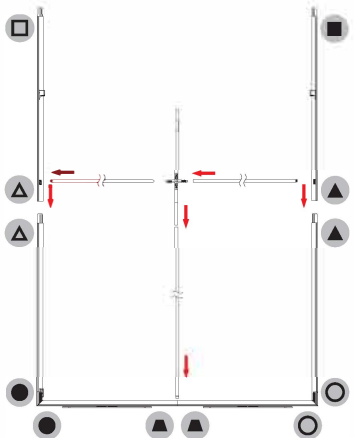
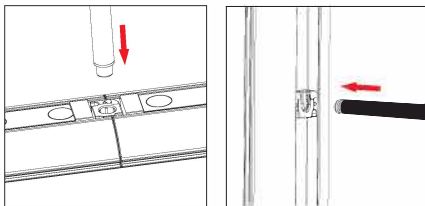

4

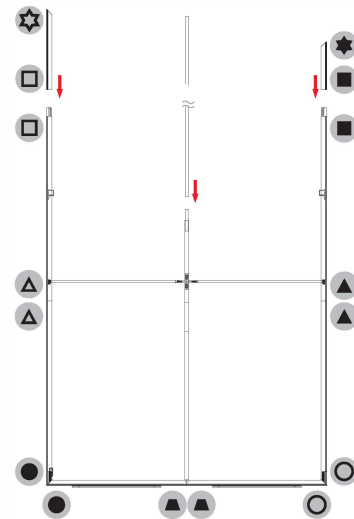
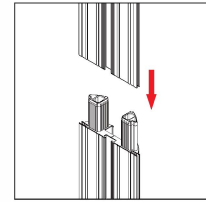

5

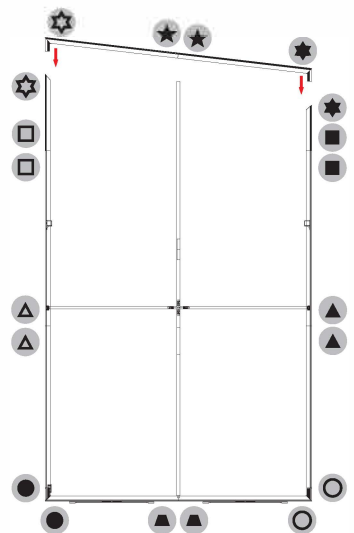
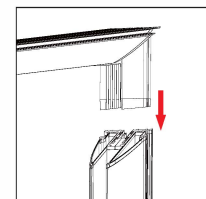

6 Push the silicone bead into each corner of the frame with your thumb.

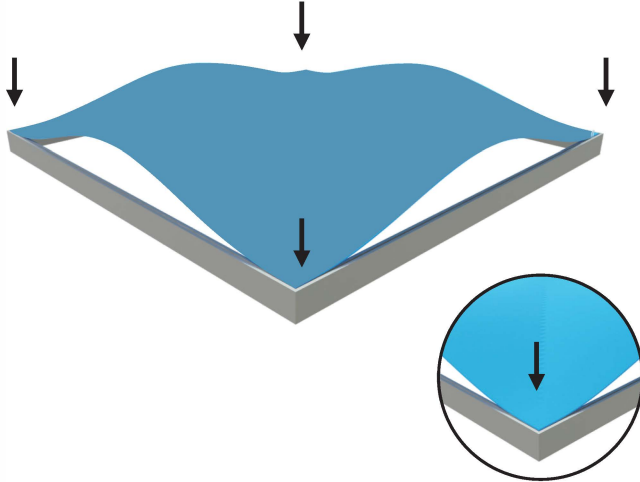

Push the silicone bead into the middle of the run and work your way around the perimeter of the frame until all beading is pushed in properly

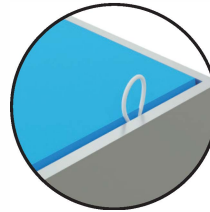
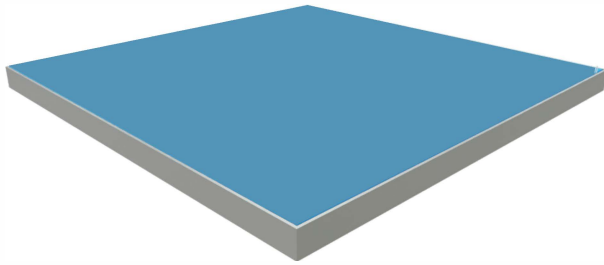
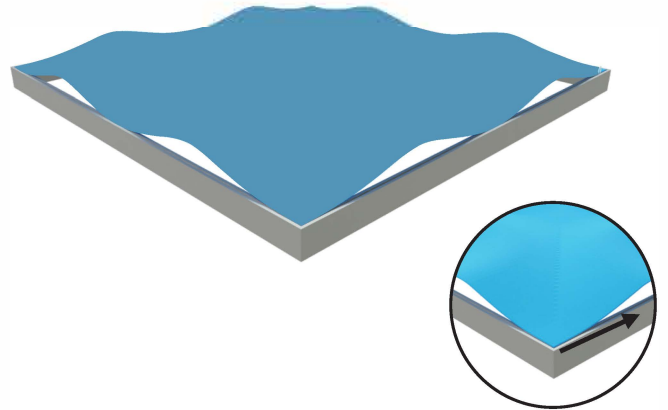

**To Remove Graphic**  
Use the pull tab located on the graphic and gently pull the graphic from the frame, going around the perimeter

7

