

# AYC-E/Q/T60 Family

Backlit *goPROX* & PIN Reader –  
Convertible Series with Genuine  
HID Technology™



Installation and Programming Manual



AYC-E60



AYC-Q60



AYC-T60

GO PROX™  
BY ROSSLARE

ROSSLARE  
SECURITY PRODUCTS

## **Copyright © 2013 by Rosslare. All rights reserved.**

This manual and the information contained herein are proprietary to ROSSLARE ENTERPRISES LIMITED and/or its related companies and/or subsidiaries' (hereafter: "ROSSLARE"). Only ROSSLARE and its customers have the right to use the information.

No part of this manual may be re-produced or transmitted in any form or by any means, electronic or mechanical, for any purpose, without the express written permission of ROSSLARE.

ROSSLARE owns patents and patent applications, trademarks, copyrights, or other intellectual property rights covering the subject matter in this manual.

TEXTS, IMAGES, AND ILLUSTRATIONS INCLUDING THEIR ARRANGEMENT IN THIS DOCUMENT ARE SUBJECT TO THE PROTECTION OF COPYRIGHT LAWS AND OTHER LEGAL RIGHTS WORLDWIDE. THEIR USE, REPRODUCTION, AND TRANSMITTAL TO THIRD PARTIES WITHOUT EXPRESS WRITTEN PERMISSION MAY RESULT IN LEGAL PROCEEDINGS.

The furnishing of this manual to any party does not give that party or any third party any license to these patents, trademarks, copyrights or other intellectual property rights, except as expressly provided in any written agreement of ROSSLARE.

ROSSLARE reserves the right to revise and change this document at any time, without being obliged to announce such revisions or changes beforehand or after the fact.

# Table of Contents

<b>1. Introduction</b>	<b>9</b>
1.1 Key Features	9
1.1.1 Reader	10
1.1.2 Controller	10
1.2 Box Content	11
1.3 Ancillary Equipment	11
<b>2. Technical Specifications</b>	<b>12</b>
<b>3. Installation</b>	<b>14</b>
3.1 Mounting the AYC-E/T60	14
3.2 Mounting the AYC-Q60	15
<b>4. Wiring Instructions</b>	<b>17</b>
<b>5. Reader Functionality</b>	<b>21</b>
5.1 Transmit Mode	21
5.2 Programming the AYC-E/Q/T60 Series	21
5.2.1 Entering Programming Mode	23
5.2.2 Exiting Programming Mode	23
5.2.3 Selecting Keypad Transmission Format	24
5.2.4 Keypad Transmission Format Option Number	25
5.2.5 Selecting HID Prox Card Transmission Format	30
5.2.6 Selecting Rosslare Proximity Card Transmission Format	30
5.2.7 Changing the Programming Code	32
5.2.8 Changing the Facility Code	33
5.2.9 Setting the Backlight Behavior	33
5.2.10 Setting the Reader Format	34

## Table of Contents

---

5.2.11	Return to Factory Default Settings .....	35
5.2.12	Replacing a Lost Programming Code .....	35
<b>6.</b>	<b>Controller Functionality.....</b>	<b>36</b>
6.1	Normal, Secure, and Master Users.....	36
6.2	Modes of Operation .....	37
6.2.1	Normal Mode .....	37
6.2.2	Bypass Mode .....	37
6.2.3	Secure Mode .....	38
6.3	Changing the Modes of Operation.....	38
6.3.1	Changing from Normal Mode to Secure Mode .....	38
6.3.2	Changing from Secure Mode to Normal Mode .....	38
6.3.3	Changing from Normal Mode to Bypass Mode .....	39
6.3.4	Changing from Bypass Mode to Normal Mode .....	39
6.4	Auxiliary Input and Output.....	40
6.5	Door Alarms .....	40
6.6	Internal Case and Back Tamper .....	40
6.7	Lockout Feature (Keypad/Card Tamper) .....	40
6.8	REX Function .....	41
6.9	Secured Series Intelligent Power Supply .....	41
6.10	Programming the AYC-E/Q/T60 .....	42
6.10.1	Entering Programming Mode.....	43
6.10.2	Exiting Programming Mode .....	43
6.10.3	Changing Lock Strike Code .....	44
6.10.4	Changing Auxiliary Code .....	44
6.10.5	Changing the Programming Code .....	45
6.10.6	Changing the Normal/Secure Code .....	46
6.10.7	Changing the Normal/Bypass Code and Door Chime Settings .....	46

6.10.8	Setting Fail Safe/Secure Operation, Tamper Siren and Lock Strike Release Time.....	47
6.10.9	Defining the Auxiliary Input and Output .....	48
6.10.10	Detailed Reference Guide .....	51
6.10.11	Setting the Lockout Feature.....	55
6.10.12	Setting the Backlight Behavior .....	56
6.10.13	Selecting the Rosslare Proximity and HID Prox Format.....	56
6.10.14	Enrolling Primary and Secondary Codes .....	57
6.10.15	Deleting Primary and Secondary Codes.....	61
6.10.16	Relay Codes Assignment.....	63
6.10.17	PIN Code Length/Factory Default Settings.....	66
6.10.18	Replacing a Lost Programming Code .....	67
6.10.19	Replacing a Lost Normal/Secure Code.....	67
<b>A.</b>	<b>Declaration of Conformity.....</b>	<b>68</b>
<b>B.</b>	<b>Limited Warranty .....</b>	<b>69</b>

# List of Figures

Figure 1: Drilling & Mounting Template for AYC-E60 .....	14
Figure 2: Drilling & Mounting Template for AYC-T60 .....	14
Figure 3: Drilling & Mounting Template for AYC-Q60 .....	16
Figure 4: Controller Application Wiring Diagram .....	18
Figure 5: Auxiliary Output Connection with Internal Power .....	19
Figure 6: Auxiliary Output Connection with External Power.....	19
Figure 7: Reader Application Wiring Diagram .....	20

## List of Tables

Table 1: Wiring Colors.....	17
Table 2: Reader Programming Menu .....	22
Table 3: Keypad Transmission Format.....	25
Table 4: Controller Programming Menu .....	42
Table 5: Quick Reference Guide for Auxiliary Mode Setting.....	50

# Notice and Disclaimer

This manual's sole purpose is to assist installers and/or users in the safe and efficient installation and usage of the system and/or product, and/or software described herein.

**BEFORE ATTEMPTING TO INSTALL AND/OR USE THE SYSTEM, THE INSTALLER AND THE USER MUST READ THIS MANUAL AND BECOME FAMILIAR WITH ALL SAFETY REQUIREMENTS AND OPERATING PROCEDURES.**

- The system must not be used for purposes other than those for which it was designed.
- The use of the software associated with the system and/or product, if applicable, is subject to the terms of the license provided as part of the purchase documents.
- ROSSLARE exclusive warranty and liability is limited to the warranty and liability statement provided in an appendix at the end of this document.
- This manual describes the maximum configuration of the system with the maximum number of functions, including future options. Therefore, not all functions described in this manual may be available in the specific system and/or product configuration you purchased.
- Incorrect operation or installation, or failure of the user to effectively maintain the system, relieves the manufacturer (and seller) from all or any responsibility for consequent noncompliance, damage, or injury.
- The text, images and graphics contained in the manual are for the purpose of illustration and reference only.
- All data contained herein subject to change without prior notice.
- In no event shall manufacturer be liable for any special, direct, indirect, incidental, consequential, exemplary or punitive damages (including, without limitation, any and all damages from business interruption, loss of profits or revenue, cost of capital or loss of use of any property or capital or injury).
- All graphics in this manual are for reference only, some deviation between the image(s) and the actual product may occur.
- All wiring diagrams are intended for reference only, the photograph or graphic of the PCB(s) are intended for clearer illustration and understanding of the product and may differ from the actual PCB(s).



# 1. Introduction

The AYC-E/Q/T60 is a family of Rosslare *goPROX* & PIN readers with Genuine HID Technology™, as well as Rosslare's Convertible technology. The AYC-E/Q/T60 series automatically determines whether to function as a reader or as a secured standalone controller. If the unit is connected to a standard access control unit, then it functions as a reader. If the unit is connected to a Rosslare secured intelligent power supply such as the PS-A25T, PS-C25T, or PS-C25TU, it functions as a 500 user secured standalone controller.

As a reader, the units can read **all** HID Prox cards/tags (125 kHz FSK) using Genuine HID Technology and outputs HID Prox card data in Wiegand according to the number of bits of data stored on the card. The units also read Rosslare proximity cards (125 kHz) and can output Rosslare proximity card data as Wiegand 26-Bit, Clock & Data, and Wiegand + PIN.

As a controller, the units accept up to 500 users, and allow entry via a personal identification number (PIN) and/or by presenting a proximity card. The PIN code length for the controller has several options. The PIN code length can be a set number of 4, 5, or 6 digits or it can be flexible from 4 to 8 digits.

## 1.1 Key Features

The key features for the AYC-E/Q/T60 series are:

- Built-in proximity card reader (125 kHz Rosslare proximity/HID Prox Modulation)
- Programmable blue backlit keypad
- UL-294 Attack Class III
- Optical back tamper sensor and open collector tamper output
- Lockout feature on wrong entry (keypad/card tamper)
- Internal buzzer provides audible interface feedback
- Two status/programming interface LEDs (tri-colored)
- Fully-potted construction for outdoor use

## Introduction

---

- Comes with mounting template for easier installation
- Comes with an installation kit that includes a security screw and a security screw tool

### 1.1.1 Reader

- Programmable keypad transmission format
- LED control input
- Programmable Facility code
- Rosslare proximity card transmission formats:
  - Clock & Data
  - Wiegand 26-Bit
  - Card + PIN
- HID Prox Card Transmission Format
  - Wiegand (outputs per format on the card)

### 1.1.2 Controller

- Bi-directional secure communication
- Three user levels: Normal, Secure, Master
- Code Search feature that helps make maintaining user codes easier
- Three modes of operation: Normal, Bypass, Secure
- REX input
- Chime bell and siren features are available
- Programmable Lock Strike Release, Siren, and Alarm Delay timers
- Programmable auxiliary input with versatile functions
- Programmable auxiliary output functions
- Programmable PIN code length



UL listed panic hardware must be used to allow emergency exit from the protected area.

## 1.2 Box Content

Before beginning, verify that all of the following is in the box. If anything is missing, please report the discrepancy to your nearest Rosslare office.

- One AYC-E/Q/T60 unit
- Installation kit – includes security Torx screw and security Torx Screw tool
- Installation and operating instructions

## 1.3 Ancillary Equipment

The following equipment is required to complete your installation:

- When functioning as a reader:  
Compatible Host Controller (not supplied) – UL listed access control unit (such as model AC-215U)
- When functioning as a controller:  
A secured series intelligent power supply – such as the PC-25T, PS-A25T, PS-C25T, or PS-C25TU secure controllers.



Only PS-C25TU can be used for UL-294 compliant installations.

Note

This unit connects to the following:

- Electric lock strike mechanism or a magnetic lock device, which implements fail safe (power to lock) or fail secure (power to open) functions
- Request-to-Exit (REX) button – normally open type. Switch is closed when pressed
- Door monitor switch

Rosslare accessories can be found on [www.rosslaresecurity.com](http://www.rosslaresecurity.com).

## 2. Technical Specifications

<b>Electrical Characteristics</b>	
<b>Power Supply Type</b>	Linear type (recommended)
<b>Operating Voltage Range</b>	E/T: 6–16 VDC Q: 5–16 VDC (when used as a controller, provided by the secured series intelligent power supply)
<b>Input current standby (12 VDC)</b>	110 mA
<b>Input Current Max (16 VDC)</b>	130 mA
<b>LED Control Input</b>	Dry contact N.O.
<b>Tamper Output</b>	Open collector, active low, 32 mA max sink current
<b>Cable Distance to Host Controller</b>	Up to 150 m (500 ft) using an 18-AWG cable
<b>Max. Proximity Card Read Range*</b>	Rosslare proximity: E – 40 mm (1.57 in.), Q – 45 mm (1.77 in.), T – 40 mm (1.57 in.) HID Prox: E – 40 mm (1.57 in.), Q – 45 mm (1.77 in.), T – 30 mm (1.18 in.)
<b>Proximity Card Modulation</b>	Rosslare proximity/HID Prox at 125 kHz
<b>Proximity Card Compatibility</b>	Rosslare proximity/HID Prox cards
<b>Card Transmit Format (Reader)</b>	Rosslare proximity cards: Wiegand 26-bit, or Clock & Data HID cards: According to card type
<b>Keypad Transmit Format (Reader)</b>	Programmable PIN code formats
<b>LED Indicators</b>	Two tri-colored LEDs
<b>Communication</b>	Data1/C1, Data0/C2—open collector, 5 V termination

## Environmental Characteristics

<b>Operating Temp. Range</b>	-22°F to 150°F (-30°C to 65°C)
<b>Operating Humidity Range</b>	0 to 95% (non-condensing)
<b>Outdoor Usage</b>	Weather-resistant, meets IP-65, epoxy potted, suitable for indoor and outdoor use

## Physical Characteristics

<b>Size (Height x Width x Depth)</b>	E: 155 x 44 x 9 mm (6.10 x 1.7 x 0.35 in.)
	Q: 120 x 76 x 21 mm (4.72 x 2.99 x 0.83 in.)
	T: 121 x 70 x 8 mm (4.77 x 2.76 x 0.31 in.)
<b>Weight</b>	E: 143 g (5.04 oz)
	Q: 480 g (16.93 oz)
	T: 121 g (4.27 oz)

\* Measured using a Rosslare proximity card or equivalent. Range also depends on electrical environment and proximity to metal.

### 3. Installation

The AYC-E/Q/T60 should be installed at shoulder height.

#### 3.1 Mounting the AYC-E/T60

*To mount the AYC-E/T60:*

1. For wall mounting, use the included mounting template as a guide for drilling holes for mounting screws and wiring (Figure 1 and Figure 2). For US Gang Box mounting, no drilling is necessary.

**Figure 1: Drilling & Mounting Template for AYC-E60**

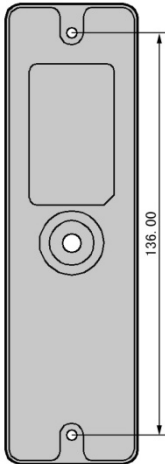

**Figure 2: Drilling & Mounting Template for AYC-T60**

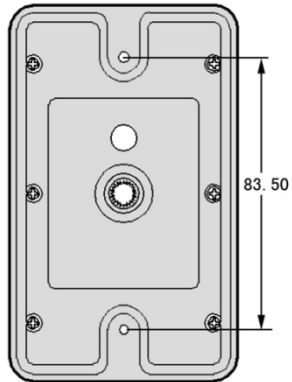

2. When the unit is used as a reader, route the interface cable from the AYC-E/T60 to the controller. A linear type power supply is recommended when using the unit as a reader

3. When the unit is used as a secured controller, route the interface cable from the AYC-E/T60 to a Rosslare secured series intelligent power supply.
4. Screw the AYC-E/T60 to its mounting location.
5. Return the AYC-E/T60 front cover to the mounted back plate.
6. Secure the front cover by using the supplied security Torx screw in the controller's installation kit. A Torx security screw tool is provided for use when tightening the security Torx screw.

### **3.2 Mounting the AYC-Q60**

Attach the reader to a surface before connecting it to its power and the access control computer.

#### *To mount the AYC-Q60:*

1. Remove the reader's front cover using the security spline key.  
The screw holes on the back plate are now visible.
2. Select an approximate location for the reader.
3. Peel off the back of the self-adhesive installation template and attach the template to the required location.
4. Using the template as a guide, drill four holes into the surface.  
The required hole size is marked on the template.

**Figure 3: Drilling & Mounting Template for AYC-Q60**

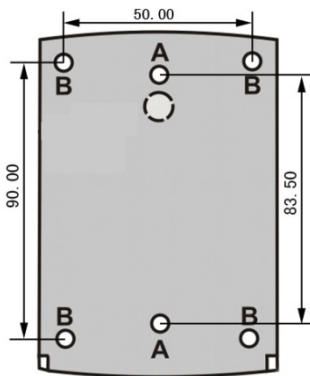

5. Drill an additional 10-mm ( $\frac{7}{16}$ " ) hole for the cable.  
When installing the reader on a metallic surface, cover the inside of the hole with a grommet or electrical tape.
6. Route the reader's cable to the power and access control system.  
A regulated linear power supply is recommended.
7. Screw the back plate into the surface. Ensure the screws are the size specified on the installation template.
8. Alternatively, the reader can be mounted with any strong epoxy glue:
  - a. Apply the glue.
  - b. Hold the reader's back plate firmly in place until the glue dries.
9. Re-attach the reader's front cover.



## 4. Wiring Instructions

The unit is supplied with 56-cm (22") pigtail, having a 6-conductor cable.

### *To connect the unit to the controller:*

1. Prepare the unit's cable by cutting the cable jacket back 3.2 cm (1¼") and stripping the wire 1.3 cm (½").
2. Splice the unit's pigtail wires to the corresponding controller wires and cover each connection.

Refer to Table 1 and to the wiring diagrams provided on the following pages.

**Table 1: Wiring Colors**

Reader	Controller	Color	Functionality
5~16 VDC	5~16 VDC	Red	+DC Input
Shield/Ground	Shield/Ground	Black	Ground
Data 1/Clock	C 1	White	Communication
Data 0/Data	C 2	Green	Communication
G.LED/LEDCTL	AUX. IN	Brown	LED Control/Auxiliary Input
Tamper	Tamper	Purple	Tamper

3. If the tamper output is used, connect the purple wire to the correct input on the controller when used as a reader, or to a zone input of an intruder alarm system when used as a controller.
4. Trim and cover all unused conductors.



- The individual wires from the unit are color-coded according the Wiegand standard.
- When using a separate Power Supply for the Reader, this Power Supply and that of the Controller must have a common ground.
- The Reader's cable shield wire should preferably be attached to an earth ground, or a signal ground connection at the panel, or power supply end of the cable. This configuration is best for shielding the Reader cable from external interference

## Wiring Instructions

Figure 4 shows the wiring for the Controller Application using a secured intelligent power supply.

**Figure 4: Controller Application Wiring Diagram**

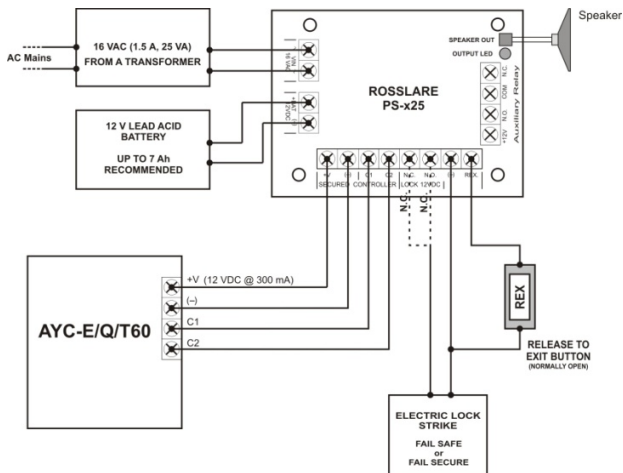

Figure 5 shows the auxiliary output connection using internal power.

**Figure 5: Auxiliary Output Connection with Internal Power**

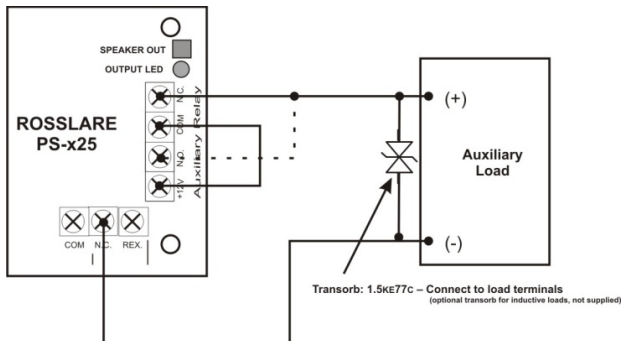

Figure 6 shows the auxiliary output connection using the external power.

**Figure 6: Auxiliary Output Connection with External Power**

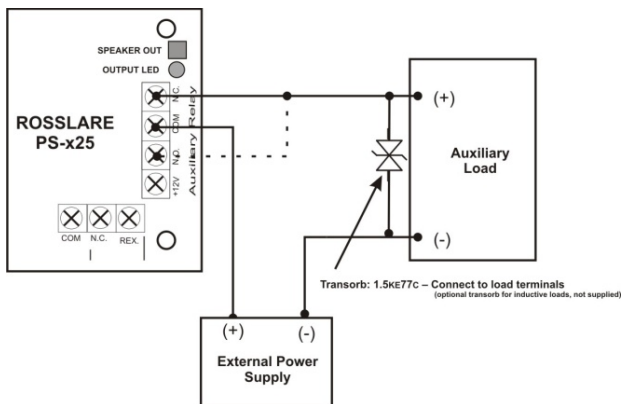
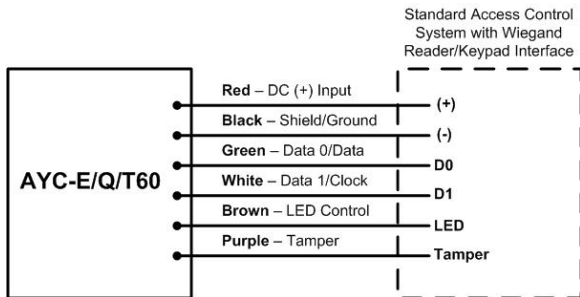

Figure 7 shows how to wire a reader to an access control panel.

Figure 7: Reader Application Wiring Diagram





## 5. Reader Functionality

The AYC-E/Q/T60 series can function both as a reader and as a controller. If the unit is connected to standard access controller, it functions as a reader, indicated by one beep immediately after power-on reset.

The following explains how the AYC-E/Q/T60 series functions as a reader.

### 5.1 Transmit Mode

When the AYC-E/Q/T60 is in Transmit mode, it is ready to receive data from a presented proximity card or an entered PIN code.

When the reader is in Transmit mode, **Mode/Transmit**   **Door/Program**  
the Transmit LED is red and the **Red**  
Program LED is off.

When a proximity card or keyboard entry is being transmitted, the Transmit LED flashes green.

Keyboard data can be sent via one of eight different Keypad Transmission Formats. For more information, see Section 5.2.3.

Proximity cards presented to the reader are always sent in either Wiegand, Clock & Data or, Wiegand Card + PIN format 9 (see Section 5.2.5).

### 5.2 Programming the AYC-E/Q/T60 Series

Programming the AYC-E/Q/T60 series is done solely via the unit's keypad driven Programming Menu System. During the AYC-E/Q/T60's manufacturing process, certain codes and settings are pre-programmed. These settings are called the default factory settings.

## Reader Functionality

---

Table 2 shows the names of all the AYC-E/Q/T60 menus. Default factory settings are marked by \*.

**Table 2: Reader Programming Menu**

<b>Menu Description</b>	<b>Default</b>
<b>1 Selecting Keypad Transmission Format</b> Single Key, Wiegand 6-Bit (Rosslare Format) Single Key, Wiegand 6-Bit with Nibble + Parity Bits Single Key, Wiegand 8-Bit, Nibbles Complemented 4 Keys Binary + Facility code, Wiegand 26-Bit 1 to 5 Keys + Facility code, Wiegand 26-Bit 6 Keys Binary-Coded Decimal (BCD) and Parity Bits, Wiegand 26-Bit Single Key, 3x4 Matrix Keypad 1 to 8 Keys BCD, Clock & Data Single key, Wiegand 4-Bit	*
<b>2 Selecting Rosslare Proximity Card Transmission Format</b> Wiegand 26-Bit Clock & Data Wiegand Card + PIN	*
<b>3 Changing the Programming code</b>	1234
<b>4 Changing the Facility code</b>	0
<b>6 Setting the Backlight</b> Always off Always on 10 sec. backlight after key press otherwise off 10 sec. backlight after key press otherwise dimmed	*
<b>6 Setting Reader Format</b> Rosslare Proximity HID Prox Rosslare Proximity + HID Prox	*
<b>0 Return to Factory Default Settings</b>	

## 5.2.1 Entering Programming Mode

To reach the Programming Menu System, the AYC-E/Q/T60 must first be placed into Programming mode.

### *To enter Programming mode:*

1. Press # four times.

Transmit LED turns off.

Mode/Transmit   Door/Program  
Red

Program LED turns red.

2. Enter your Programming code.

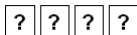

If the Programming code is valid, the door LED turns green and the AYC-E/Q/T60 is in Programming mode.

Mode/Transmit   Door/Program  
Green



Note

- The factory 4-digit Programming code is 1234.
- If a Programming code is not entered within 30 seconds, the AYC-E/Q/T60 returns to Transmit mode.

## 5.2.2 Exiting Programming Mode

### *To exit Programming mode:*

1. Press #.

You hear a beep.

Mode/Transmit   Door/Program  
Red

The Program LED is off.

The Transmit LED turns red.

This indicates that the AYC-E/Q/T60 has returned to Transmit mode.

Wrong entries may reset the reader back to Transmit mode. While in Programming mode, if no key is pressed for 30 seconds, the AYC-E/Q/T60 exits Programming mode and returns to Transmit mode.

### 5.2.3 Selecting Keypad Transmission Format

The AYC-E/Q/T60 has nine different keypad transmission formats from which to select.

*To select the keypad transmission format:*

1. Enter Programming mode. Mode/Transmit   Door/Program  
Green

2. Press **1** to enter Menu 1.

1

The Transmit LED turns red.

Mode/Transmit   Door/Program  
Red Green

3. Enter the appropriate option number for the keypad transmission format that you wish to select (see Section Table 3).

?

You hear three beeps.

Mode/Transmit   Door/Program  
Red

The system returns to Transmit mode.

If an incorrect option number is entered, the reader returns to Transmit mode and the keypad transmission format remains unchanged.



- Only one keypad transmission format can be active at any one time.
- When using the keypad transmission format "1 to 8 keys BCD, Clock & Data" (Option 8) an additional input is required to specify the number of keys in the PIN code.



## 5.2.4 Keypad Transmission Format Option Number

See Table 3 to determine the Option Number for the Keypad Transmission Format you wish to select.

**Table 3: Keypad Transmission Format**

<b>Keypad Transmission Format</b>	<b>Option Number</b>
Single Key, Wiegand 6-Bit (Rosslare Format)	1*
Single Key, Wiegand 6-Bit with Nibble + Parity Bits	2
Single Key, Wiegand 8-Bit, Nibbles Complemented	3
4 Keys Binary + Facility code, Wiegand 26-Bit	4
1 to 5 Keys + Facility code, Wiegand 26-Bit	5
6 Keys BCD and Parity Bits, Wiegand 26-Bit	6
Single Key, 3x4 Matrix Keypad	7
1 to 8 Keys BCD, Clock & Data Single Key	8
Single Key, Wiegand 4-Bit	9

\* Option 1 is the default factory setting.

More information on each of the different keypad transmission formats is available in the following subsections.

### 5.2.4.1 Option 1: Single Key, Wiegand 6-Bit (Rosslare Format)

Each key press immediately sends 4 bits with 2 parity bits added – even parity for the first 3 bits and odd parity for the last 3 bits.

0 = 1 1010 0 = "A" in Hexadecimal	6 = 1 0110 0
1 = 0 0001 0	7 = 1 0111 1
2 = 0 0010 0	8 = 1 1000 1
3 = 0 0011 1	9 = 1 1001 0
4 = 1 0100 1	* = 1 1011 1 = "B" in Hexadecimal
5 = 1 0101 0	# = 0 1100 1 = "C" in Hexadecimal

### 5.2.4.2 Option 2: Single Key, Wiegand 6-Bit Nibble and Parities

Each key press immediately sends 4 bits with 2 parity bits added – even parity for the first 3 bits and odd parity for the last 3 bits.

0 = 0 0000 1	6 = 1 0110 0
1 = 0 0001 0	7 = 1 0111 1
2 = 0 0010 0	8 = 1 1000 1
3 = 0 0011 1	9 = 1 1001 0
4 = 1 0100 1	* = 1 1010 0 = "A" in Hexadecimal
5 = 1 0101 0	# = 1 1011 1 = "B" in Hexadecimal

### 5.2.4.3 Option 3: Single Key, Wiegand 8-Bit Nibbles Complemented

This options inverts the most significant bits in the message leaving the least 4 significant bits as BCD representation of the key. The host system receives an 8-bit message.

0 = 11110000	6 = 10010110
1 = 11100001	7 = 10000111
2 = 11010010	8 = 01111000
3 = 11000011	9 = 01101001
4 = 10110100	* = 01011010 = "A" in Hexadecimal
5 = 10100101	# = 01001011 = "B" in Hexadecimal

### 5.2.4.4 Option 4: 4 Keys Binary + Facility Code, Wiegand 26-Bit

This option buffers 4 keys and outputs keypad data with a 3-digit Facility code like a standard 26-bit card output.

The Facility code is set in Programming Menu 4 and can be in the range 000 to 255. The factory default setting for the Facility code is 000 (see Section 5.2.8 for more information).

The keypad PIN code is 4 digits in length and can range between 0000 and 9999. On the fourth key press of the 4-digit PIN code, the data is sent across the Wiegand Data lines as binary data in the same format as a 26-bit card.

If \* or # are pressed during PIN code entry, the keypad clears the PIN code entry buffer, generates a beep, and is ready to receive a new 4-digit keypad PIN code.

If the entry of the 4-digit keypad PIN code is disrupted and no number key is pressed within 5 seconds, the keypad clears the PIN code entry buffer, generates a beep, and is ready to receive a new 4-digit keypad PIN code:

(EP) FFFF FFFF AAAA AAAA AAAA AAAA (OP)

Where:

EP = Even parity for first 12 bits

OP = Odd parity for last 12 bits

F = 8-Bit Facility code

A = 16-Bit code generated from keyboard

#### **5.2.4.5 Option 5: 1 to 5 Keys + Facility Code, Wiegand 26-Bit**

Option 5 buffers up to 5 keys and outputs keypad data with a Facility code like a 26-bit card output.

The Facility code is set in Programming Menu 4 and can be in the range 000 to 255. The factory default setting for the Facility code is 000 (see Section 5.2.8 for more information). The keypad PIN code can be one to five digits in length and can range between 1 and 65,535. When entering a keypad PIN code that is less than 5 digits in length, # must be pressed to signify the end of PIN code entry. For keypad PIN codes that are 5 digits in length, on the fifth key press of the 5-digit PIN code, the data is sent across the Wiegand Data lines as binary data in the same format as a 26-bit card.

If \* is pressed during PIN code entry or a PIN code greater than 65,535 is entered, the keypad clears the PIN code entry buffer, generates a beep and is ready to receive a new 5-digit keypad PIN code.

If the entry of the 1- to 5-digit keypad PIN code is disrupted and a number key or # is not pressed within 5 seconds, the keypad clears the PIN code entry buffer, generates a medium length beep, and is ready to receive a new 1- to 5-digit keypad PIN code:

(EP) FFFF FFFF AAAA AAAA AAAA AAAA (OP)

Where:

EP = Even parity for first 12 bits

OP = Odd parity for last 12 bits

F = 8-Bit Facility code

A = 16-Bit code generated from keyboard

### **5.2.4.6 Option 6: 6 Keys BCD and Parity Bits, Wiegand 26-Bit**

This option sends buffer of 6 keys, adds parity, and sends a 26-bit BCD message. Each key is a four bit equivalent of the decimal number.

The keypad PIN code must be 6 key presses in length. On the sixth key press of the 6-digit PIN code, the data is sent across the Wiegand Data lines as a BCD message.

If the entry of the 6-digit keypad PIN code is disrupted and a number key or # is not pressed within 5 seconds, the keypad clears the PIN code entry buffer, generates a medium length beep, and is ready to receive a new 6-digit keypad PIN code:

(EP) AAAA BBBB CCCC DDDD EEEE FFFF (OP)

Where:

EP = Even parity for first 12 bits

OP = Odd parity for last 12 bits

A = The first key entered

D = Fourth key entered

B = Second key entered

E = Fifth key entered

C = Third key entered

F = Sixth key entered

### **5.2.4.7 Option 7: Single Key, 3x4 Matrix Keypad (MD-P64)**

This unique mode is intended to let the host controller scan the AYC-E/Q/T60 keypad while still keeping the proximity card readers Wiegand 26-Bit or Clock & Data formats active.

An optional interface board must be used between the AYC-E/Q/T60 and the host system. Each key press is immediately sent on DATA0 as an ASCII character at a baud rate of 9600 bits per second.

When a key is pressed, DATA1 is pulled "low" until the key is released at which point DATA1 is set to "high". This allows the controller to detect the duration of the key press.

The MD-P64 interface unit outputs the data received to 7 outputs emulating a keyboard. The interface unit does not affect any data that it receives from the proximity reader whether it is Wiegand 26-Bit or Clock & Data.

Key pressed = ASCII Value

0 = '0' ( 0x30 hex )	6 = '6' ( 0x36 hex )
1 = '1' ( 0x31 hex )	7 = '7' ( 0x37 hex )
2 = '2' ( 0x32 hex )	8 = '8' ( 0x38 hex )
3 = '3' ( 0x33 hex )	9 = '9' ( 0x39 hex )
4 = '4' ( 0x34 hex )	* = '*' ( 0x2A hex )
5 = '5' ( 0x35 hex )	# = '#' ( 0x23 hex )

#### 5.2.4.8 Option 8: 1 to 8 Keys BCD, Clock & Data

Option 8 buffers up to 8 keys and outputs keypad data without a Facility code like standard Clock and Data card output.

The keypad PIN code can be one to eight digits in length. The PIN code length is selected while programming the reader for Option 8. The reader transmits the data when it receives the last key press of the PIN code. The data is sent across the two data output lines as binary data in Clock & Data format.

If \* or # is pressed during PIN code entry, the keypad clears the PIN code entry buffer, generates a beep, and is ready to receive a new keypad PIN code.

If the entry of the keypad PIN code is disrupted and a number key or # is not pressed within 5 seconds, the keypad clears the PIN code entry buffer, generates a medium length beep, and is ready to receive a new keypad PIN code.



When using the keypad transmission format " 1 to 8 keys BCD, Clock & Data" (Option 8), an additional input is required to specify the number of keys in the PIN code.

### 5.2.4.9 Option 9: Single Key, Wiegand 4-Bit

With this option, each key press immediately sends 4 bits of data, with no parity bits added.

0 = 0000	6 = 0110
1 = 0001	7 = 0111
2 = 0010	8 = 1000
3 = 0011	9 = 1001
4 = 0100	* = 1010 = "A" in Hexadecimal
5 = 0101	# = 1011 = "B" in Hexadecimal

### 5.2.5 Selecting HID Prox Card Transmission Format

The AYC-E/Q/T60 can read **all** HID Prox Cards/Tags (125 kHz) using Genuine HID Technology and outputs HID Prox card data in Wiegand according to the number of bits of data stored on the card.

### 5.2.6 Selecting Rosslare Proximity Card Transmission Format

The AYC-E/Q/T60 can read Rosslare proximity cards (125 kHz) and can output Rosslare proximity card data as Wiegand 26-Bit, Clock & Data, and Wiegand + PIN.

*To select the Rosslare proximity card transmission format:*

1. Enter Programming mode.      Mode/Transmit   Door/Program  
Green

2. Press **2** to enter Menu 2.

**2**

The Transmit LED turns red.      Mode/Transmit   Door/Program  
Red      Green

3. Enter the appropriate option number for the Rosslare proximity card transmission format that you wish to select:
- Option 1: Wiegand 26-Bit
  - Option 2: Clock & Data
  - Option 3: Wiegand Card + PIN

You hear three beeps.

Mode/Transmit   Door/Program  
Red

The system returns to Transmit mode.

If an incorrect option is entered, the reader returns to Transmit mode and the keypad transmission format remains unchanged.

### 5.2.6.1 "Wiegand Card + PIN" Transmission Format

This unique mode is intended to let host controllers get card and keypad data simultaneously. This option overrides the selected Keypad Transmission Format and sends the keypad data as described below.

After a card is presented to AYC-E/Q/T60, the program LED starts to flash in green and indicates that AYC-E/Q/T60 is waiting for the PIN code. If the entry of 1- to 5-digit keypad PIN code is disturbed and a number key or # is not pressed within 5 seconds, the keypad clears the card buffer and the PIN code entry buffer, generates a medium length beep, and is ready to receive a new card.

The keypad PIN code can be one to five digits in length in the range of 0 to 99,999. When entering a keypad PIN code, # must be pressed to signify the end of the PIN entry. When pressing #, the data is sent by the Wiegand data lines. If \* is pressed, the keypad clears the card buffer and the PIN code entry buffer, generates a medium length beep, and is ready to receive a new card.

The AYC-E/Q/T60 output card data is in Wiegand 26-Bit with the following keypad data in Wiegand 26-Bit format.

Card Data: (EP) AAAA AAAA AAAA BBBB BBBB BBBB (OP)

Where:

EP = Even parity for first 12 A bits

OP = Odd parity for last B 12 bits

PIN Data: (EP) 0000 AAAA BBBB CCCC DDDD EEEE (OP)

Where:

A = The first key entered

D = Fourth key entered

B = Second key entered

E = Fifth key entered

C = Third key entered

EP = Even parity for first 12 bits    OP = Odd parity for last 12 bits

If the PIN code is less than 5 digits, all the most significant nibbles are filled with 0.

Example: (EP) 0000 0000 0000 0000 AAAA BBBB (OP)

Where:

A = The first key entered

B = Second key entered

EP = Even parity for first 12 bits    OP = Odd parity for last 12 bits

### 5.2.7 Changing the Programming Code

*To change the Programming code:*

1. Enter Programming mode.

Mode/Transmit  Door/Program  
Green

2. Press **3** to enter Menu 3.

3

The Transmit LED turns red.

Mode/Transmit  Door/Program  
Red Green

3. Enter the new 4-digit code you wish to set as the Programming code.

? ? ? ?

You hear three beeps.

Mode/Transmit  Door/Program  
Red

The system returns to Transmit mode.





- The Programming code cannot be erased; the code 0000 is invalid and does not erase the Programming code.
- The factory default 4-digit Programming code is 1234.

## 5.2.8 Changing the Facility Code

### *To change the Facility code:*

1. Enter Programming mode.

Mode/Transmit   Door/Program  
Green

2. Press **4** to enter Menu 4.

4

The Transmit LED turns red.

Mode/Transmit   Door/Program  
Red Green

3. Enter the new 3-digit code you wish to set as the Facility code.

? ? ?

You hear three beeps.

Mode/Transmit   Door/Program  
Red

The system returns to Transmit mode.



- The Facility code can be in the range of 000 to 255.
- The default Facility code is 0.

## 5.2.9 Setting the Backlight Behavior

### *To set the backlight behavior:*

1. Enter Programming mode.

Mode/Transmit   Door/Program  
Green

2. Press **6** to enter Menu 6.



6

The Transmit LED turns red.

Mode/Transmit   Door/Program  
Red Green

- Enter one of the following codes:
  - 10** – Always off
  - 11** – Always on
  - 12** – Backlight is off, activates for 10 seconds when a key is pressed (Mode LED also goes on), after which it dims until off (Mode LED also goes off)
  - 13** – Backlight is dimmed, activates for 10 seconds when a key is pressed (Mode LED also goes on), after which it returns to a dimmed level

You hear three beeps.

Mode/Transmit   Door/Program  
Red

The system returns to Transmit mode.

### 5.2.10 Setting the Reader Format

*To set the reader format:*



- Enter Programming mode.

Mode/Transmit   Door/Program  
Green

- Press **6** to enter Menu 6.

**6**

The Transmit LED turns red.

Mode/Transmit   Door/Program  
Red Green

- Enter the appropriate option number for the reader format:

- 61** for Rosslare proximity
- 62** for HID Prox
- 63** for Rosslare proximity and HID Prox (default)

You hear three beeps.

Mode/Transmit   Door/Program  
Red

The system returns to Transmit mode.

## 5.2.11 Return to Factory Default Settings



You must be very careful before using this command! This erases the entire memory and returns all codes to their factory default setting.

### *To return to factory default settings:*

1. Enter Programming mode. Mode/Transmit   Door/Program  
Green

2. Press **0** to enter Menu 0.



The Transmit LED flashes red.



The Program LED flashes red.

3. Enter your Programming code.

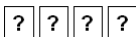

If the Programming code is valid, all memory is erased, you hear three beeps and the controller returns to Normal mode.

If the Programming code is invalid, you hear a long beep and the controller returns to Normal mode without erasing the memory of the controller.

## 5.2.12 Replacing a Lost Programming Code

In the event that the Programming code is forgotten, the AYC-E/Q/T60 may be reprogrammed in the field using the following instructions:

### *To replace a lost Programming code:*

1. Remove power from the reader.
2. Activate the tamper by removing the reader from the wall or removing the reader's case.
3. Apply power to the reader.
4. You now have 10 seconds to enter Programming mode using the factory default Programming code 1234.

# 6. Controller Functionality

The AYC-E/Q/T60 series can function both as a reader and as a controller. If the unit is connected to a Rosslare secured series intelligent power supply, it functions as a controller indicated by two beeps immediately after power-on reset.

The Lock Strike Output and REX input are not located on the AYC-E/Q/T60 unit, eliminating the possibility of unauthorized entry to the restricted area.

This chapter explains how the AYC-E/Q/T60 series functions as a controller.

## 6.1 Normal, Secure, and Master Users

The AYC-E/Q/T60 accepts up to 500 users and provides entry via the use of PIN codes and/or Proximity cards. Each user is provided with two code memory slots: Memory Slot 1 (Primary code) and Memory Slot 2 (Secondary code).

The PIN code length has several options. The PIN code length can be a set number of 4, 5 or 6 digits or it can be a 4–8 digits option. When choosing the 4–8 digit option, please note that you should either enter zeros before the code, or press # at the end (for example if your code is 12345, enter either **00012345** or **12345#**).



Entering a code refers to either PIN or card depending on the model you have.

The way in which the two memory slots are programmed determines a user's access level and also determines the way in which the AYC-E/Q/T60 grants access in its three modes of operation. There are three user levels:

- Normal User – A Normal User only has a Primary code and is only granted access when the AYC-E/Q/T60 is in Normal or Bypass mode.

- **Secure User** – A Secure User must have a Primary and Secondary code programmed; the two codes must not be the same. The Secure User can gain access when the AYC-E/Q/T60 is in any of its three modes of operation. In Normal mode, the Secure User must use the Primary code to gain entry. In Secure mode, the Secure User must present both the Primary and Secondary codes to gain entry.
- **Master User** – A Master User must have both Primary and Secondary codes programmed with the same code. The Master User can gain access during any mode of operation by presenting the PIN code and/or Proximity card once to the controller. (The Master User is convenient but is less secure than a Secure User.)

## 6.2 Modes of Operation

The AYC-E/Q/T60 has three modes of operation:

### 6.2.1 Normal Mode

The Mode LED is green.

Mode/Transmit   Door/Program  
Green

Normal mode is the default mode. In Normal mode, the door is locked until a Primary code is presented to the controller. Special codes such as Lock Strike code and Auxiliary code are active in Normal mode. (See Sections 6.10.3 and 6.10.4 for more information.)

### 6.2.2 Bypass Mode

The Mode LED is orange.

Mode/Transmit   Door/Program  
Orange

In Bypass mode, access to the premises is dependent on whether the controller's Lock Strike Relay is programmed for Fail Safe Operation or Fail Secure Operation. When the Lock Strike is programmed for Fail Secure Operation, the door is locked until \* is pressed. When the Lock Strike is programmed for Fail Safe Operation, the door is constantly unlocked.

### 6.2.3 Secure Mode

The Mode LED is red.

Mode/Transmit   Door/Program  
Red

Only Secure and Master Users can access the premises during the Secured mode.

A Secure User must enter their Primary and Secondary codes to gain entry. After entering their Primary code, the Door LED flashes green for 10 seconds, during which the Secondary code must be entered. A Master User only needs to present the code once to gain entry.

## 6.3 Changing the Modes of Operation

### 6.3.1 Changing from Normal Mode to Secure Mode

The default factory setting for the Normal/Secure code is 3838.

*To change from Normal to Secure mode:*

1. Enter the Normal/Secure code. Mode/Transmit   Door/Program  
Green

The Mode LED flashes red. Mode/Transmit   Door/Program  
Red

2. Press # to confirm the mode change.

The Mode LED turns red. Mode/Transmit   Door/Program  
Red

### 6.3.2 Changing from Secure Mode to Normal Mode

The default factory setting for the Normal/Secure code is 3838.

*To change from Secure to Normal mode:*

1. Enter the Normal/Secure code. Mode/Transmit   Door/Program  
Red

The Mode LED flashes green. Mode/Transmit   Door/Program  
Green

- Press # to confirm the mode change.

The Mode LED turns green.

Mode/Transmit   Door/Program  
Green

### 6.3.3 Changing from Normal Mode to Bypass Mode

See Section 6.10.7 to create/modify the Normal/Bypass code.

*To change from Normal to Bypass mode:*

- Enter the 4-digit Normal/Bypass code.

Mode/Transmit   Door/Program  
Green

The Mode LED flashes orange.

Mode/Transmit   Door/Program  
Orange

- Press # to confirm the mode change.

The Mode LED turns orange.

Mode/Transmit   Door/Program  
Orange

### 6.3.4 Changing from Bypass Mode to Normal Mode

See Section 6.10.7 to create/modify the Normal/Bypass code.

*To change from Bypass to Normal mode:*

- Enter the 4-digit Normal/Bypass code.

Mode/Transmit   Door/Program  
Orange

The Mode LED flashes green.

Mode/Transmit   Door/Program  
Green

- Press # to confirm the mode change.

The Mode LED turns green.

Mode/Transmit   Door/Program  
Green

### **6.4 Auxiliary Input and Output**

For optimum usability in different applications, the controller's auxiliary input and output can be configured in 10 different modes of operation.

### **6.5 Door Alarms**

Door alarms can be generated by connecting the Auxiliary Input to a Door Position Switch. Either Door-Forced or Door-Ajar conditions are supported, as well as a configurable delay timer for each alarm type. Only one door-alarm is enabled at any one time. Door alarms may activate auxiliary output and siren depending on the auxiliary settings.

### **6.6 Internal Case and Back Tamper**

If the unit is forcibly opened or it is removed from the wall, a tamper event is triggered. A tamper output opens sending a signal to the connected alarm system (purple wire); the event closes when the tamper is closed (case is re-closed or re-attached to the wall).

The tamper event can also activate the auxiliary output if the controller is in Auxiliary Mode 3 (see Table 5).

### **6.7 Lockout Feature (Keypad/Card Tamper)**

If the controller is presented with wrong codes (PIN or Card) consecutively several times, the unit goes into Lockout mode.

When a lockout occurs, the controller's reader and keypad are deactivated so no codes can be entered until the set lockout period expires.

During Lockout, Mode LED is off, the Door LED flashes red, and the controller beeps every two seconds.



### 6.8 REX Function

The REX button is connected to a Rosslare secured series intelligent power supply. The REX button must be located inside the premises to be secured and is used to open the door without the use of a PIN code. It is usually located in a convenient location, such as inside the door or at a receptionist's desk. The function of the REX button depends on whether the Lock Strike Relay is programmed for Fail Safe Operation or Fail Secure Operation.

- Fail Secure Operation: From the moment the REX button is pressed, the door is unlocked until the Lock Strike Release Time passes. After this time, the door is locked even if the REX button is not released.
- Fail Safe Operation: From the moment the REX button is pressed, the door is unlocked until the REX button is released, plus the Lock Strike Release Time. In this case, the Lock Strike Relay only begins its count down once the REX button is released.

### 6.9 Secured Series Intelligent Power Supply

Rosslare's secured series intelligent power supplies are designed for use with Rosslare's secured series standalone access control units, including AYC-E/Q/T60. It is designed to operate indoors and installed within the secured premises.

The AYC-E/Q/T60 must be used with one of Rosslare's secured series intelligent power supplies, which provide Lock Strike output and REX input.

Both units communicate through a proprietary Rosslare protocol, which provides a secure link between the AYC-E/Q/T60 and the secured series intelligent power supply unit. This in turn activates the door lock.

The units also function as the power supply for the AYC-E/Q/T60; each unit also contains a speaker connection for all sounder abilities.

For more information, see the specific secured series intelligent power supply manual.

### 6.10 Programming the AYC-E/Q/T60

Programming the AYC-E/Q/T60 is performed solely via the unit's keypad driven Programming Menu System. To reach the Programming Menu System, the AYC-E/Q/T60 must first be placed into Programming mode. See Section 6.10.1 for more information. During the AYC-E/Q/T60's manufacturing process, certain codes and settings are pre-programmed. These settings are called the default factory settings. Table 4 shows the names of all the AYC-E/Q/T60 menus. It also shows of all the AYC-E/Q/T60's default factory codes and settings.

**Table 4: Controller Programming Menu**

Menu No.	Menu Description	Default			
		4 digits	5 digits	6 digits	4-8 digits
1	Changing Lock Strike Code	2580	25802	258025	25802580
2	Changing Auxiliary Code	0852	08520	085208	08520852
3	Changing Program Code	1234	12341	123412	12341234
4	Changing Normal/Secure Code	3838	38383	383838	38383838
5	Changing Normal/Bypass Code	N/A			
6	Changing Door Release Time	0004			
	Defining auxiliary inputs/outputs	2004			
	Set Lockout	4000			
	Backlight Behavior	5100			
	Rosslare proximity/HID Prox format	6300			
7	Enrolling PIN Code				
8	Deleting PIN Code				
9	Code assignment with strike/auxiliary				
0	Return to factory defaults/Change PIN code Length				

You will find a complete description and instructions for each of the above menu items on the following subsections.

### 6.10.1 Entering Programming Mode

*To enter Programming mode:*

1. Press # twice within 2 seconds.

The Mode LED turns off and the Door LED turns red

Mode/Transmit   Door/Program  
Red

2. Enter your Programming code.

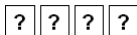

The Door LED turns green and the AYC-E/Q/T60 enters Programming mode.

Mode/Transmit   Door/Program  
Green



Note

- The AYC-E/Q/T60 must be in Normal mode to enter Programming mode.
- The factory four-digit Programming code is 1234.
- If a Programming code is not entered within five seconds, the AYC-E/Q/T60 returns to Normal mode.

### 6.10.2 Exiting Programming Mode

*To exit Programming mode:*

1. Press # twice within 2 seconds.

You hear 3 beeps.

The Door LED turns off and the Mode LED turns green.

Mode/Transmit   Door/Program  
Green

Wrong entries may reset the controller back to Normal mode.

While in Programming mode, if no key is pressed for one minute, the AYC-E/Q/T60 exits Programming mode and returns to Normal mode.

### 6.10.3 Changing Lock Strike Code

The Lock Strike code is mainly used as a method to quickly test the Lock Strike Relay during installation.

When the first user is added to the controller, the default Lock Strike code is automatically deleted. Once the code is programmed again, it is not deleted with the entry of additional User codes.

#### *To change the Lock Strike code:*

1. Enter Programming mode.

Mode/Transmit   Door/Program  
Green

2. Press **1** to enter Menu 1.

1

The Mode LED turns red.

Mode/Transmit   Door/Program  
Red Green

3. Enter the new code you wish to set as the Lock Strike code.

? ? ? ?

You hear three beeps.

The system returns to Normal mode.

Mode/Transmit   Door/Program  
Green



Note

- Lock Strike code does not work in the Secure mode.
- Wrong entries return the controller to Normal mode.
- Code 0000 erases the Lock Strike code.
- The factory DEFAULT 4-digit Lock Strike code is 2580.

### 6.10.4 Changing Auxiliary Code

The Auxiliary code is mainly used as a method to quickly test the Auxiliary Relay during installation.

#### *To change the Auxiliary code:*

1. Enter Programming mode.

Mode/Transmit   Door/Program  
Green

2. Press **2** to enter Menu 2.

2

The Mode LED turns orange.

Mode/Transmit   Door/Program  
Orange Green

3. Enter the new code you wish to set as the Auxiliary code.

You hear three beeps.

Mode/Transmit   Door/Program  
Green

The system returns to Normal mode.



- Auxiliary code does not work in the Secure mode.
- Wrong entries return the controller to Normal mode.
- Code 0000 erases the Auxiliary code.
- The factory default 4-digit Auxiliary code is 0852.

## 6.10.5 Changing the Programming Code



### *To change the Programming code:*

1. Enter Programming mode.

Mode/Transmit   Door/Program  
Green

2. Press **3** to enter Menu 3.

The Mode LED turns green.

Mode/Transmit   Door/Program  
Green Green

3. Enter the new code you wish to set as Programming code.

You hear three beeps.

Mode/Transmit   Door/Program  
Green

The system returns to Normal mode.

## Controller Functionality



- The Programming code cannot be erased; the code 0000 is invalid and does not erase the Programming code.
- The factory default 4-digit Programming code is 1234.

### 6.10.6 Changing the Normal/Secure Code

*To change the Normal/Secure code:*

1. Enter Programming mode. **Mode/Transmit**   **Door/Program Green**

2. Press **4** to enter Menu 4.

4

The Mode LED flashes red.

**Mode/Transmit**   **Door/Program Green**  
Red Green

3. Enter the new code you wish to set as Normal/Secure code.

? ? ? ?

You hear three beeps.

**Mode/Transmit**   **Door/Program Green**  
Green

The system returns to Normal mode.



- Code 0000 erases the Normal/Secure code.
- This code is disabled if the Auxiliary Input is set to toggle between Normal and Secure access modes.
- The default Normal/Secure code is 3838.

### 6.10.7 Changing the Normal/Bypass Code and Door Chime Settings

*To change the Normal/Bypass code and door chime settings:*

1. Enter Programming mode. **Mode/Transmit**   **Door/Program Green**

2. Press **5** to enter Menu 5.

5

The Mode LED flashes orange.

**Mode/Transmit**   **Door/Program Green**  
Orange Green

3. There are four different ways to program the Normal/Bypass code and door chime:

- Disable both Bypass code and the door chime. Enter the code **0000**. 0 0 0 0
- Disable Bypass code and enable the door chime. Enter the code **0001**. 0 0 0 1
- Enable Bypass code and disable the door chime. Enter any code ending with 0. ? ? ? 0
- Enable Bypass code and enable the door chime. Enter a code not ending with 0. ? ? ? 0

You hear three beeps.  
The system returns to Normal mode.

Mode/Transmit  Green  Door/Program Green

## 6.10.8 Setting Fail Safe/Secure Operation, Tamper Siren and Lock Strike Release Time

*To set the Fail Safe/Secure Operation, Tamper Siren and Lock Strike Release Time:*

1. Enter Programming mode.

Mode/Transmit   Door/Program Green

Press **6** to enter Menu 6.

6

The Mode LED flashes green.

Mode/Transmit  Green  Door/Program Green

## Controller Functionality

2. Construct a code using the following instructions:
- First Digit  
For Fail Secure Operation, the first digit should be **0**.  
For Fail Safe Operation the first digit should be **1**.
  - Second Digit  
Siren Time in minutes (1-9, 0-disabled)
  - Third and Fourth Digits  
Enter the number of seconds (from 1 to 99) that you want the Lock Strike to be released.

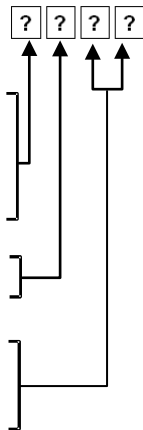

For example, **0312** means a Fail Secure Operation consisting of a 3-minute siren and a 12-second Lock Strike release time.

You hear three beeps.

The system returns to Normal mode.

Mode/Transmit  Green  Door/Program



The default value is 0004, which corresponds to Fail Secure operation, no siren, and 4-seconds Lock Strike release time.

### 6.10.9 Defining the Auxiliary Input and Output

The default auxiliary setting is 2004.

*To define the auxiliary input and output:*

1. Enter Programming mode.

Mode/Transmit   Door/Program  
Green

2. Press **6** to enter Menu 6.

**6**



The Mode LED flashes green.

Mode/Transmit  Door/Program  
Green Green

3. Construct a code using the following instructions:

Auxiliary Mode \_\_\_\_\_

Auxiliary Setting \_\_\_\_\_

**2** **?** **?** **?**



- Auxiliary Mode



In addition to the Lock Strike Relay and Lock Strike REX, the AYC-E/Q/T60 features an Auxiliary Input. The Auxiliary mode defines the function of the Auxiliary Input.

- Auxiliary Settings

Each of the Auxiliary modes has a two digit setting that affects how the Auxiliary mode functions (Table 5).

You hear three beeps.

The system returns to Normal mode.

Mode/Transmit  Door/Program  
Green 

**Table 5: Quick Reference Guide for Auxiliary Mode Setting**

<b>Auxiliary Mode</b>	<b>Auxiliary Input Function</b>	<b>Auxiliary Output Activated by</b>	<b>Auxiliary Relay</b>	<b>Auxiliary Settings (in seconds)</b>
0	AUX REX	Valid code or AUX REX	N.O.	01 to 99 Aux. relay release time 00 Aux. relay toggle
1	Normal/Secure switch	Valid code	N.O.	01 to 99 Aux. relay release time 00 Aux. relay toggle
2	Normal/Secure switch	Star button (★)	N.O.	01 to 99 Aux. relay release time 00 Aux. relay toggle
3	Normal/Secure switch	Tamper event	N.C.	01 to 99 Aux. relay release time 00 Aux. relay tamper activated
4	Normal/Secure switch	Direct shunt	N.O.	01 to 99 Shunt time
5	Door Monitor	Shunt	N.C.	01 to 99 Maximum shunt time
6	Door Monitor	Forced door	N.C.	01 to 99 Forced delay
7	Door Monitor	Door ajar	N.C.	01 to 99 Ajar delay
8	LED control – Green	Valid code	N.O.	01 to 99 Aux. relay release time 00 Aux. relay toggle
9	LED control – Red	Valid code	N.O.	01 to 99 Aux. relay release time 00 Aux. relay toggle

### 6.10.10 Detailed Reference Guide

The following are brief descriptions of each auxiliary mode. To implement the features of each mode, refer to Section 6.10.9.

#### 6.10.10.1 Auxiliary Mode 0

**Auxiliary input function:** Activates the auxiliary output

**Auxiliary output activated by:** Valid user code, Auxiliary code, Auxiliary input

For example, in Auxiliary Mode 0, the controller can function as a two-door controller. The auxiliary relay is to be attached to the lock on the second door. The auxiliary setting defines the door open time for the second door. The auxiliary input is to be attached to the REX pushbutton for the second door. The Door Monitor input feature for the second door is not enabled when using this mode.

#### 6.10.10.2 Auxiliary Mode 1

**Auxiliary input function:** Toggles Normal/Secure modes

**Auxiliary output activated by:** Valid user code, Auxiliary code

For example, in Auxiliary Mode 1, the controller can function as a two-door controller. The auxiliary relay is to be attached to the lock on the second door. REX feature for the second door is not enabled when using this mode.

The auxiliary setting defines the door open time for the second door. The auxiliary input can switch the mode of operation of the controller between Normal and Secure mode. By connecting a switch timer or alarm system output to the auxiliary input, the controller can be automatically switched from Normal mode (during office hours) to Secure mode (after office hours).

#### 6.10.10.3 Auxiliary Mode 2

**Auxiliary input function:** Toggles normal/secure modes

**Auxiliary output activated by:** Asterisk Button (\*)

For example, in Auxiliary Mode 2, the auxiliary relay can function as a general purpose time switch that can be activated when the asterisk button (\*) is depressed. The auxiliary setting establishes for how long

the auxiliary relay is to be activated. The auxiliary input can switch the mode of operation of the controller between Normal and Secure modes. By connecting a switch timer or alarm system output to the auxiliary input, the controller can be automatically switched from Normal mode (during office hours) to Secure mode (after office hours).

### 6.10.10.4 Auxiliary Mode 3

**Auxiliary input function:** Toggles Normal/Secure modes

**Auxiliary output activated by:** Alarms

For example, in Auxiliary Mode 3, the auxiliary output is activated if the controller is tampered; that is, if the case is forcibly opened or removed from the wall. The auxiliary input can switch the mode of operation of the controller between Normal and Secure modes. By connecting a switch timer or alarm system output to the auxiliary input, the controller can be automatically switched from Normal mode (during office hours) to Secure mode (after office hours).

### 6.10.10.5 Auxiliary Mode 4

**Auxiliary input function:** Toggles Normal/Secure modes

**Auxiliary output activated by:** Direct shunt (explanation below)

For example, in Auxiliary Mode 4, the controller is capable of bypassing an alarm zone by shunting an alarm system's door sensor. The auxiliary output is to be wired in parallel to the door sensor output. When in use, the auxiliary output is normally open and the door sensor functions normally. When a valid code is entered, the auxiliary relay shunts the door sensor for the duration of the shunt time, as defined by the auxiliary setting. If the door is left open longer than the shunt time, an alarm is triggered.

### 6.10.10.6 Auxiliary Mode 5

**Auxiliary input function:** Door Monitor

**Auxiliary output activated by:** Shunt (explanation below)

For example, in Auxiliary Mode 5, the controller is capable of shunting an alarm system. In this mode, the auxiliary input is to be wired to the magnetic contact switch on the door. The auxiliary relay is wired to the alarm system. Without a valid code entered, the auxiliary relay matches the condition of the magnetic contact switch; if the door opens, the auxiliary relay opens; if the door closes, the auxiliary relay closes. When a valid code is entered, a countdown for maximum shunt time, as defined by the auxiliary setting, begins; if the door is not closed before the maximum shunt time, the alarm is triggered.

### 6.10.10.7 Auxiliary Mode 6

**Auxiliary input function:** Door Monitor

**Auxiliary output activated by:** Forced entry

For example, in Auxiliary Mode 6, the controller can trigger the auxiliary relay if the door has been forced. If the siren settings are enabled, the siren is activated.

In this mode, the auxiliary input functions as a door monitor switch and is wired to the magnetic contact switch on the door. The auxiliary relay is to be wired to the alarm system. If the door is forced open, the controller waits for the period of the forced door delay time to elapse and then it activates the auxiliary relay. The auxiliary setting sets the forced door delay period.

### 6.10.10.8 Auxiliary Mode 7

**Auxiliary input function:** Door Monitor

**Auxiliary output activated by:** Door Ajar (door held open)

For example, in Auxiliary Mode 7, the controller can trigger the auxiliary relay, if it detects that the door has been held open (ajar) too long. In this mode, the auxiliary input functions as a door monitor switch and is wired to the magnetic contact switch on the door. The auxiliary relay is to be wired to the alarm system. If the door is opened, the controller waits for the Door Ajar Delay time to elapse

and if the door does not close prior to the end of this period, the controller activates the auxiliary relay. The auxiliary setting defines the door-ajar time.

### 6.10.10.9 Auxiliary Mode 8

**Auxiliary input function:** Green LED control

**Auxiliary output activated by:** Valid user code, Auxiliary code

For example, in Auxiliary Mode 8, the controller can function as a two-door controller and also provide indicator functionality control. The auxiliary relay is connected to the lock on the second door. The auxiliary setting defines the door open time for the second door. The auxiliary input is used to control the door indicator. If the auxiliary input is open, the indicator flashes green; if the auxiliary input is closed, the door indicator flashes red.



Note

This mode takes control of the Door Indicator LED.

The indicator LED is not lit when:

- A valid code is entered
- While in Secure mode when waiting for secondary code.

### 6.10.10.10 Auxiliary Mode 9

**Auxiliary input function:** Red LED control

**Auxiliary output activated by:** Valid user code, Auxiliary code

For example, in Auxiliary Mode 9, the controller can function as a two-door controller and also provide indicator functionality control. The auxiliary relay is connected to the lock on the second door. The auxiliary setting defines the door open time for the second door. The auxiliary input is used to control the indicator. If the auxiliary input is open, the door indicator flashes red; if the auxiliary input is closed the door indicator flashes green.



Note

This mode takes control of the Door Indicator LED.

The indicator LED is not lit when:

- A valid code is entered
- While in Secure mode when waiting for secondary code.

### 6.10.11 Setting the Lockout Feature

If the controller is presented with wrong codes consecutively several times, the unit goes into Lockout mode.

When a lockout occurs, the controller keypad and reader are locked so no codes can be entered until the set lockout period expires. During Lockout, Mode LED is off, the door LED flashes red, and the controller beeps every two seconds. The default setting for the Lockout Feature is 4000 (Lockout Disabled).



Using the lockout feature is highly recommended, especially when using a short PIN code length (4 or 5 digits).

#### *To set the lockout feature:*

1. Enter Programming mode.

Mode/Transmit   Door/Program  
Green

2. Press **6** to enter Menu 6.

6

The Mode LED flashes green.

Mode/Transmit   Door/Program  
Green Green

3. Construct a code using the following instructions:

Set the number of wrong code attempts, which causes a Lockout between 0 and 9 attempts.

Sets the Duration of the lockout, between 00 and 99; the value is multiplied by ten, resulting in 0 to 990 seconds.

4 ? ? ?

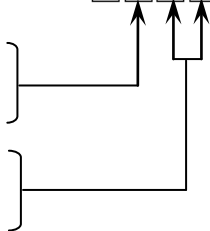

### 6.10.12 Setting the Backlight Behavior

The controller allows you to define the way the units' Backlight works.

*To set the backlight behavior:*



1. Enter Programming mode.

Mode/Transmit   Door/Program  
Green

2. Press **6** to enter Menu 6.

**6**

The Mode LED flashes green.

Mode/Transmit   Door/Program  
Green Green

3. Enter one of the following codes:

- **5000** – Backlight off
- **5100** – Backlight on (default)
- **5200** – Backlight is off, activates for 10 seconds when a key is pressed (Mode LED also goes on), after which it dims until off (Mode LED also goes off)
- **5300** – Backlight is dimmed, activates for 10 seconds when a key is pressed (Mode LED also goes on), after which it returns to a dimmed level

### 6.10.13 Selecting the Rosslare Proximity and HID Prox Format

The controller allows you to select the Rosslare proximity and HID Prox format.

*To select the Rosslare proximity and HID Prox format:*



1. Enter Programming mode.

Mode/Transmit   Door/Program  
Green

2. Press **6** to enter Menu 6.

**6**

The Mode LED flashes green.

Mode/Transmit   Door/Program  
Green Green



3. Enter one of the following codes:
  - **6100** – Rosslare Proximity
  - **6200** – HID Prox
  - **6300** – Rosslare Proximity + HID Prox (default)

### 6.10.14 Enrolling Primary and Secondary Codes

- Primary codes
  - Primary codes can only be enrolled to an empty user slot, meaning a slot where there is no existing primary code.
  - Primary codes must be unique, meaning one user's Primary code may not be the same as other user's Primary code.
  - Primary codes cannot be the same as any system codes, such as the Normal/Secure code or Lock Strike code.
  - Users who hold a Primary code can gain entry only during Normal mode.
- Secondary codes
  - Secondary codes can only be enrolled to user slot that already has a Primary code enrolled but no Secondary code.
  - Secondary codes do not have to be unique, meaning multiple users can all hold the same Secondary code.
  - Secondary codes cannot be the same as any system codes, such as the Normal/Secure code or Lock Strike codes.
  - Users who hold Secondary codes can gain entry in any mode of operation.

There are two methods to enroll Primary and Secondary codes:

- Standard Method

The Standard Method is mainly used when the user slot number for the user you wish to program is known. You can program both Primary and Secondary codes using the Standard Method (see Section 6.10.14.1).

## Controller Functionality

---

- Code Search Method

The Code Search Method is mainly used when enrolling a user's Secondary code and the User Slot code is unknown.

The Code Search method only works if a user's Primary code is already enrolled but the Secondary code is not (see Section 6.10.14.2).

### 6.10.14.1 Enrolling Primary and Secondary Codes using the Standard Method

*To enroll primary and secondary codes using the Standard method:*

1. Enter Programming mode.

Mode/Transmit   Door/Program  
Green

2. Press **7** to enter Menu 7.

**7**

The Door LED turns orange.



Mode/Transmit   Door/Program  
Orange

3. Enter the 3-digit user slot number between 001 and 500 for the slot to which you wish to enroll a Primary or Secondary code.

**?** **?** **?**

For example, User Slot 003 represents User #3.



If the selected slot has no Primary code, the Mode LED flashes green, indicating that the controller is ready to accept a Primary code.

Mode/Transmit   Door/Program  
Green Orange

If the selected slot already has a Primary code but no Secondary code, the Mode LED flashes red, indicating that the controller is ready to accept a Secondary code.

Mode/Transmit  Red Door/Program  Orange

If the selected slot already has a Primary and Secondary code, you hear a long beep and the controller returns to Normal mode.

Mode/Transmit  Green Door/Program 

#### 4. Perform one of the following:

- Enter the PIN code that you want to assign as the Primary or Secondary code for this slot number.

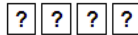

- Present your user card that you want to assign as the Primary or Secondary code for this slot number.

If the PIN or user card presented is valid, the Mode LED stops flashing and the controller is ready for you to enter the next 3-digit slot number (refer to Step 3) for the slot to which you want to assign a code.

#### 5. Do one of the following:

- Press **#** to move to the next slot number.
- If you do not wish to continue enrolling codes, press **#** twice and the controller returns to Normal mode.

### 6.10.14.2 Enrolling Secondary Codes using the Code Search Method

The Code Search feature enables you to quickly enroll a Secondary code to a user who already has a Primary code.

*To enroll secondary codes using the Code Search method:*

1. Enter Programming mode. Mode/Transmit   Door/Program Green

2. Press **7** to enter Menu 7.

The Door LED turns orange. Mode/Transmit   Door/Program Orange

3. Enter **000** as the 3-digit user slot number.

The Door LED flashes orange. Mode/Transmit   Door/Program Orange

The controller is now waiting for the Primary code of the user to whom you want to add a Secondary code.

4. Perform one of the following:
- Enter the PIN code belonging to the user for whom you wish to add a Secondary code.
  - Present the user card belonging to the user for whom you wish to add a Secondary code.

The Mode LED flashes red. Mode/Transmit   Door/Program Red Orange

If the Primary code entered is not valid, you hear a long beep and the AYC-E/Q/T60 continues to wait for a valid Primary code.

5. Perform one of the following:

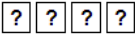
- Enter the PIN code to be used as the Secondary code. 
- Present the user card to be used as the Secondary code.

If the Secondary code is valid, the controller beeps three times and returns to Normal mode.

If the Secondary code is invalid, the controller sounds a long beep, and the AYC-E/Q/T60 continues to wait for a valid Secondary code to be entered.

### 6.10.15 Deleting Primary and Secondary Codes

There are two methods to delete Primary and Secondary codes: the Standard Method and the Code Search Method.

When deleting a user slot, both the Primary code and the Secondary code are erased.

#### 6.10.15.1 Deleting Primary and Secondary Codes using the Standard Method

*To delete the Primary and Secondary codes using the Standard Method:*

1. Enter Programming mode. Mode/Transmit   Door/Program  
Green
2. Press **8** to enter Menu 8. 

The Mode LED turns red and the Door LED turns orange. Mode/Transmit   Door/Program  
Red Orange
3. Enter the 3-digit User Slot code you wish to delete. 

## Controller Functionality

The Mode LED flashes red indicating the controller is waiting for the Programming code to confirm the deletion.

Mode/Transmit  Red Door/Program  Orange

If the user slot is empty, you hear a long beep and the AYC-E/Q/T60 returns to Normal mode.

4. Enter your Programming code to confirm the deletion.

If the Programming code is valid, three beeps are heard and the controller returns to Normal mode.

If the Programming code is invalid, a long beep is heard and the controller returns to Normal mode.



It is recommended that a record be kept of added and deleted users so that it is easier to keep track of which user slots are empty and which user slots are not.

### 6.10.15.2 Deleting Primary and Secondary Codes using the Code Search Method



*To delete the Primary and Secondary codes using the Code Search Method:*

1. Enter Programming mode.

Mode/Transmit  Door/Program  Green

2. Press **8** to enter Menu 8.

The Mode LED turns red and the Door LED turns orange.

Mode/Transmit  Red Door/Program  Orange

3. Enter **000** as the 3-digit user slot number.

The Door LED flashes orange.

Mode/Transmit  Red Door/Program  Orange

The controller is now waiting for the Primary code of the user you want to delete.

4. Perform one of the following:

- Enter the PIN code of the Primary code belonging to the user you want to delete.

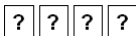

- Present the user card of the Primary code belonging to the user you want to delete.

The Mode LED flashes red.

Mode/Transmit  Red Door/Program  Orange

5. Enter your Programming code to confirm the deletion.

If the Programming code is valid, you hear three beeps and the unit returns to Normal mode.

If the Programming code is invalid, you hear a long beep and the unit returns to Normal mode.



It is recommended that a record be kept of added and deleted users so that it is easier to keep track of which user slots are empty and which user slots are not.

### 6.10.16 Relay Codes Assignment

When a primary code is enrolled for any user, the user is authorized to activate the Lock Strike relay. However, different user codes may be set to operate the auxiliary relay instead or operate both the Lock strike and auxiliary relay. Assignment of such codes is achievable for any valid user code entered in the controller.

There are two methods to assign relay codes to users: a standard method and a search method.

## Controller Functionality

---

### 6.10.16.1 Relay Code Assignment using the Standard Method

*To assign relay code using the Standard method:*

1. Enter Programming mode. Mode/Transmit   Door/Program  
Green

2. Press **9** to enter Menu 9.



The Mode LED turns green and the Door LED turns orange.

Mode/Transmit   Door/Program  
Green Orange

3. Enter the 3-digit user slot for code assignment.



The Mode LED flashes green.

Mode/Transmit   Door/Program  
Green Orange

4. Enter the assignment digit for the current user slot:

- **1** activates the Lock Strike relay only default
- **2** activates the Auxiliary relay only
- **3** activates the Lock Strike and Auxiliary relays

If the assignment code is valid, the Mode LED stops flashing.

The controller is now waiting for another slot number.

5. Press **#** to move to the next slot or enter a new slot number.
6. If you do not wish to continue, press **#** twice and the controller returns to Normal mode.

### 6.10.16.2 Relay Code Assignment using the Search Method

*To assign relay code using the Search method:*

1. Enter Programming mode. Mode/Transmit   Door/Program  
Green

2. Press **9** to enter Menu 9.





The Mode LED turns green and the Door LED turns orange.    **Mode/Transmit**  **Door/Program**  
Green    Orange

3. Enter **000** for user slot access.



The Door LED flashes orange.    **Mode/Transmit**  **Door/Program**  
Green    Orange

The controller is now waiting for the primary code of the user.

4. Do one of the following:

- Enter the PIN code.
- Present your user card.

5. The Mode LED flashes green.    **Mode/Transmit**  **Door/Program**  
Green    Orange

6. Enter the assignment digit for the current user slot:

- **1** activates the Lock Strike relay only default
- **2** activates the Auxiliary relay only
- **3** activates the Lock Strike and Auxiliary relays

If the assignment digit is valid, three beeps are heard and the controller returns to Normal mode.

If the assignment digit is invalid, a long beep sounds and the controller waits for another assignment digit to be entered.

### 6.10.17 PIN Code Length/Factory Default Settings



You must be very careful before using this command! Changing the PIN code length also erases the entire memory contents, including all user and special codes, and returns all codes to their factory-default settings.

#### *To change the PIN code length:*

1. Enter Programming mode. Mode/Transmit   Door/Program Green
2. Select the desired PIN code length as follows:
  - **00** – Returns to factory defaults and sets a 4-digit code
  - **05** – Returns to factory defaults and sets a 5-digit code
  - **06** – Returns to factory defaults and sets a 6-digit code
  - **08** – Returns to factory defaults and sets a 4-8 digit code



When choosing the 4-8 option, please note that you should either enter zeros before the code, or press pound at the end (for example if your code is 12345, enter either **00012345** or **12345#**).

Both the Mode and Door LEDs

Mode/Transmit   Door/Program Red Red

3. Enter your Programming code.

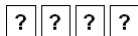

If the Programming code is valid, all memory is erased. You hear three beeps and the controller returns to Normal mode.

If the Programming code is invalid, you hear a long beep and the controller returns to Normal mode without erasing the memory contents.

### 6.10.18 Replacing a Lost Programming Code



The AYC-E/Q/T60 must be in Normal mode; otherwise, this does not work. Make sure that the Mode LED is green before proceeding.

1. Remove power from the Power Supply Unit.
2. Press the REX button on the Power Supply Unit.
3. Apply power to the unit with REX button pressed.
4. Release the REX button.
5. You now have 15 seconds to program a new Programming code into the Access Control unit using the default code based on the PIN code length you chose (see Table 4) before the controller reverts to the existing code.

### 6.10.19 Replacing a Lost Normal/Secure Code



The AYC-E/Q/T60 must be in Secure mode; otherwise, this does not work. Make sure that the Mode LED is red before proceeding.

1. Remove power from the Power Supply Unit.
2. Press the REX button on the Power Supply Unit.
3. Apply power to the unit with the REX button pressed.
4. Release the REX button.
5. You now have 15 seconds to program a new Normal/Secure code into the Access Control unit using the default code based on the PIN code length you chose (see Table 4) before the controller reverts to the existing code.

### A. Declaration of Conformity

This device complies with Part 15 of the FCC Rules. Operation is subject to the following two conditions:

- This device may not cause harmful interference.
- This device must accept any interference received, including interference that may cause undesired operation.

Changes or modifications not expressly approved by the party responsible for compliance could void the user's authority to operate the equipment.

This equipment has been tested and found to comply with the limits for a Class B digital device, pursuant to part 15 of the FCC Rules. These limits are designed to provide reasonable protection against harmful interference in a residential installation.

This equipment generates, uses, and can radiate radio frequency energy and, if not installed and used in accordance with the instructions, may cause harmful interference to radio communications. However, there is no guarantee that interference will not occur in a particular installation. If this equipment does cause harmful interference to radio or television reception, which can be determined by turning the equipment off and on, the user is encouraged to try to correct the interference by one or more of the following measures:

- Reorient or relocate the receiving antenna.
- Increase the separation between the equipment and receiver.
- Connect the equipment into an outlet on a circuit different from that to which the receiver is connected.
- Consult the dealer or an experienced radio/TV technician for help.

### B. Limited Warranty

The full ROSSLARE Limited Warranty Statement is available in the Quick Links section on the ROSSLARE website at [www.rosslaresecurity.com](http://www.rosslaresecurity.com).

Rosslare considers any use of this product as agreement to the Warranty Terms even if you do not review them.



## Asia Pacific, Middle East, Africa

Rosslare Enterprises Ltd.  
Kowloon Bay, Hong Kong  
Tel: +852 2795-5630  
Fax: +852 2795-1508  
support.apac@rosslaresecurity.com

## United States and Canada

Rosslare Security Products, Inc.  
Southlake, TX, USA  
Toll Free: +1-866-632-1101  
Local: +1-817-305-0006  
Fax: +1-817-305-0069  
support.na@rosslaresecurity.com

## Europe

Rosslare Israel Ltd.  
Rosh HaAyin, Israel  
Tel: +972 3 938-6838  
Fax: +972 3 938-6830  
support.eu@rosslaresecurity.com

## Latin America

Rosslare Latin America  
Buenos Aires, Argentina  
Tel: +54-11-4001-3104  
support.la@rosslaresecurity.com

## China

Rosslare Electronics (Shenzhen) Ltd.  
Shenzhen, China  
Tel: +86 755 8610 6842  
Fax: +86 755 8610 6101  
support.cn@rosslaresecurity.com

## India

Rosslare Electronics India Pvt Ltd.  
Tel/Fax: +91 20 40147830  
Mobile: +91 9975768824  
sales.in@rosslaresecurity.com

**ROSSLARE**  
SECURITY PRODUCTS  
[www.rosslaresecurity.com](http://www.rosslaresecurity.com)

