

SlideDriver™

Premium security
and reliability



The Premium slide gate operator

For industrial and high security



Powerful:

Move gates up to 20,000 lb.



Tough:

Secure steel chassis and taper resistant cover.



Reliable:

UPS models remain functional during a power outage.



Programmable:

Configure for specific site requirements.



Connected:

Remote monitoring, management, and maintenance.

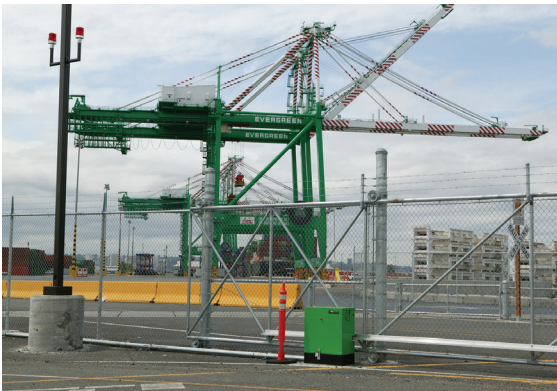



Expect More

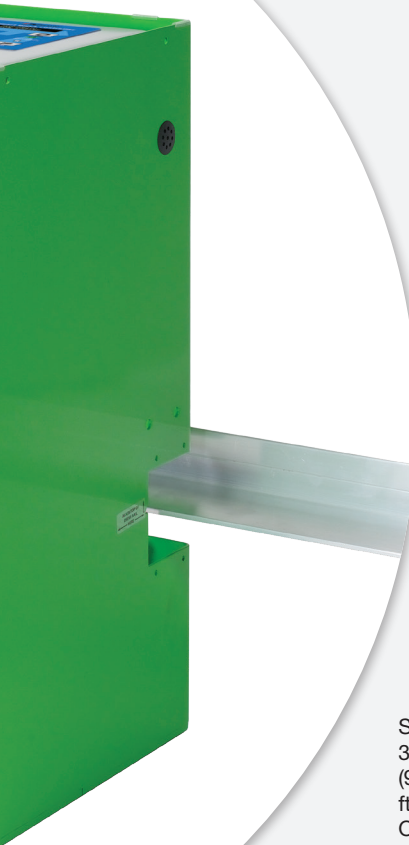

SlideDriver
32 models up to 20,000 lb gates
(9,072 kg) 1 ft/s (30 cm/s) or 3
ft/s (70cm/s) Emergency Fast
Operate option on SlideDriver
50VF 2/3



Fast:
1-3 ft/s operating speed.
Emergency fast operate
at 3 ft/s.



Smart:
Integrated primary/
secondary controls and
preprogrammed relay
settings.



**All weather
performance:**
Wide temperature range
without heater.



Durable:
Decades long life and low
maintenance.



Made in USA:
Designed, tested and built
with
global materials.



A model for every site

Powerful, rugged, continuous duty

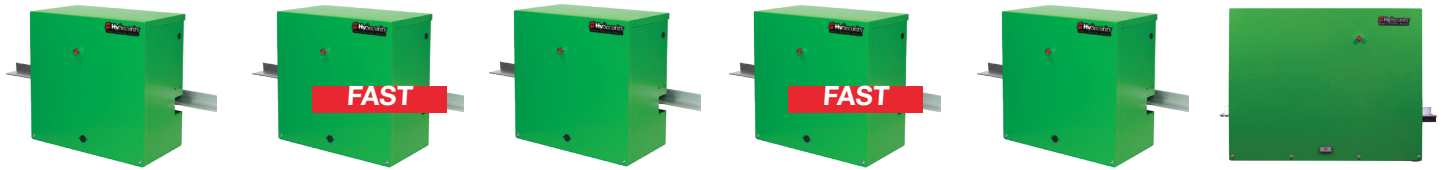

SlideDriver 15
1,500 lb gates 1 ft/s

SlideDriver 30F
3,000 lb gates 1.7 ft/s

SlideDriver 40
4,000 lb gates 1 ft/s

SlideDriver 50VF 2/3
5,000 lb gates Field adjustable 2.2 or 3 ft/s + Emergency Fast Close

SlideDriver 80
8,000 lb gates 1 ft/s

SlideDriver 200
20,000 lb gates 1 ft/s

		FAST		FAST		
	1,500 lb gates 1 ft/s	3,000 lb gates 1.7 ft/s	4,000 lb gates 1 ft/s	5,000 lb gates 2.2 ft/s or 3 ft/s	8,000 lb gates 1 ft/s	20,000 lb gates 1 ft/s
Model	SlideDriver 15	SlideDriver 30F	SlideDriver 40	SlideDriver 50VF2/3	SlideDriver 80	SlideDriver 200
Part #	222 SS ST	222 EX 1.7 ST	222 E ST	222 X3 ST	222 X1 ST	444 XS ST
Duty Cycle	Continuous					
Horsepower	1 hp UPS model: 2 hp	2 hp	1 hp UPS model: 2 hp	2 hp	2 hp	5 hp UPS model: 4 hp
Drive	Hydraulic					
Drive Wheels	Two 6 inch (15 cm) AdvanceDrive wheels	Two 6 inch (15 cm) AdvanceDrive wheels	Two 6 inch (15 cm) AdvanceDrive wheels	Two 8 inch (20 cm) AdvanceDrive wheels	One 8 inch (20 cm) AdvanceDrive wheel, One 8 inch XtremeDrive wheel and 27 ft (8 m) of rack	Two 8 inch (20 cm) AdvanceDrive wheels, Two 8 inch XtremeDrive wheels and 52 ft (16 m) of rack
Gate Weight Max.	1,500 lb (680 kg)	3,000 lb (1,361 kg)	4,000 lb (1,814 kg)	5,000 lb (2,268 kg)	8,000 lb (3,629 kg)	20,000 lb (9,072 kg)
Gate Length Max.	Limited only by weight					
Drawbar Pull	300 lb (136 kg)	300 lb (136 kg)	300 lb (136 kg)	300 lb (136 kg)	600 lb (272 kg)	1,200 lb (544 kg)
Rate of Travel	1 ft/s (30 cm/s)	1.7 ft/s (50 cm/s)	1 ft/s (30 cm/s)	Field adjustable, 2.2 ft/s (70 cm/s) or 3 ft/s (91 cm/s) Emergency Fast Operate 3 ft/s (91 cm/s)	1 ft/s (30 cm/s)	1 ft/s (30 cm/s)
Temperature Rating	-40° to 158° F (-40° to 70° C)					
1 Phase Power	115/208/230V 60 Hz 110/220V 50 Hz***	208/230V 60 Hz 220V 50 Hz***	115/208/230V 60 Hz 110/220V 50 Hz***	208/230V 50/60 Hz	208/230V 60 Hz 220V 50 Hz***	230V 60 Hz 220V 50 Hz***
3 Phase Power	208/230/460V 60Hz; 220/380/440V 50Hz***			208/230V 50/60Hz or 380/460V 50/60Hz	208/230/460V; 220/380/440V 50Hz***	
Included Accessories	One premium EMX IRB-MON photo eye, one 5-foot premium ASO edge sensor and a pre-wired Hy2NC adapter					Pre-wired Hy2NC adapter
Communication	RS-232, RS-485					
User Controls	Smart Touch Controller with 70+ configurable settings, programmed via the keypad and display or a PC using S.T.A.R.T. software.					
Relay	Three configurable user relays: one 30VDC, 3A solid state and two 250VAC, 10A electromechanical; Optional Hy8Relay™ for 8 additional relay outputs					
Finish	Zinc plated with powder coating					
ETL Listed (UL 325)	Usage Class I, II, III, IV	Usage Class III, IV	Usage Class I, II, III, IV	Usage Class III, IV	Usage Class III, IV	Usage Class III, IV
Warranty	5 year w/product registration					
UPS Battery Backup Power and Additional Models						
DC Power Supply* † with HyCharger DC AC Power Supply with HylInverter AC*	SlideDriver 15 UPS	SlideDriver 30F UPS	SlideDriver 40 UPS	-	SlideDriver 80 UPS	SlideDriver 200 UPS**
Correctional Facility	-	SlideDriver 30F-C	SlideDriver 40-C	SlideDriver 50VF2/3-C	SlideDriver 80-C	SlideDriver 200-C
Modular	SlideDriver 15-M	SlideDriver 30F-M	SlideDriver 40-M	SlideDriver 50VF2/3-M	SlideDriver 80-M	-

*3,000 ft/hr expected duty cycle. The operator's normal duty cycle and the actual number of gate cycles available from battery depends upon gate resistance to travel, cycle length, battery size, state of charge and health, ambient temperature, accessory power draw and frequency of gate cycles during power outage.
 ** SlideDriver 200 UPS has a 2,000 ft/hr (610 m/hr) expected duty cycle. Actual duty cycle depends on site specific conditions and gate configuration.
 *** Refer to Installed Options on pricing for all 50Hz voltages, which are special order.
 † 115V DC Power Supply requires a 30A branch circuit. Choose voltage with care as chargers are not field convertible.



Secure uni-body welded chassis

Constructed with rigid 12 gauge sheet metal and protected with ultra durable polyester powder coat over zinc plating for an enduring attractive finish.

Field Programmable SMART TOUCH CONTROLLER

Provides the ultimate in configurability and system troubleshooting.

ELECTRICAL ENCLOSURE

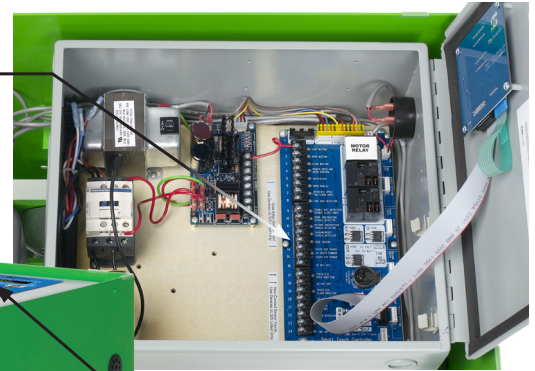

Smart Touch Controller keypad & display

Extremely reliable hydraulics

Contain only one gallon of high performance hydraulic fluid. Operates in extreme temperature range.

Industrial grade components

Ensure extremely low maintenance and exceptionally long life.

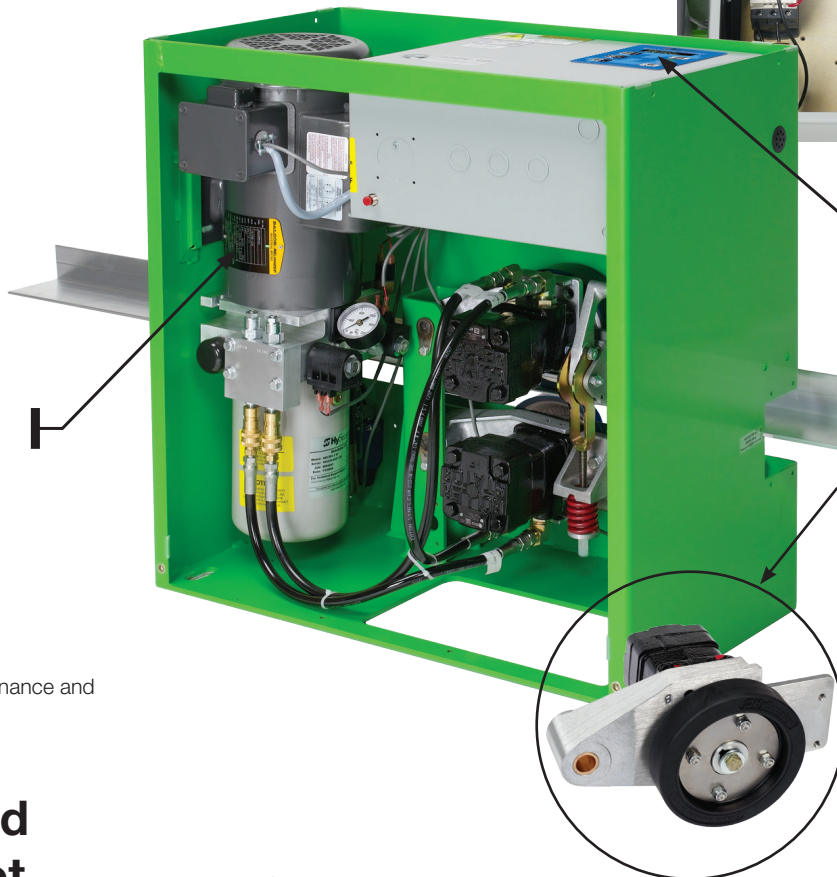

AdvanceDrive™ Wheel ENCLOSED, SECURE PINCH-WHEEL DRIVE

- No exposed chain
- Long life
- Field and factory proven under brutal conditions
- Simple, quick and inexpensive replacement
- Two year limited warranty

Program and Troubleshoot

- Microprocessor-based (Non-PLC)
- 21 field configurable inputs
- 3 field configurable user relay outputs. Hy8Relay™ option provides 8 additional user relay outputs
- 4 plug-in Hy5B™ vehicle detector sockets
- RS-232, RS-485
- Date and time stamped fault logs, errors and security alerts
- PC software simplifies configuration and troubleshooting using Smart Touch Analyze and Retrieve Tool (S.T.A.R.T.)
- Unparalleled power surge/lighting strike protection
- Easy one wire input terminal connections and common wire buss

Smart Touch Controller

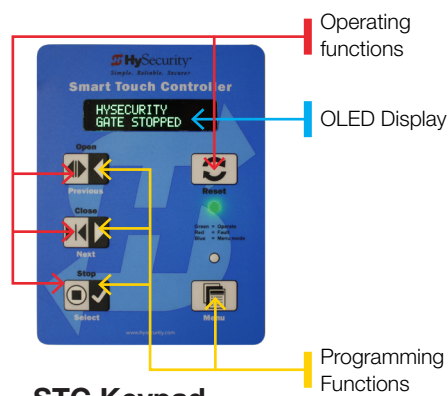

STC Board

used with all HySecurity hydraulic operators

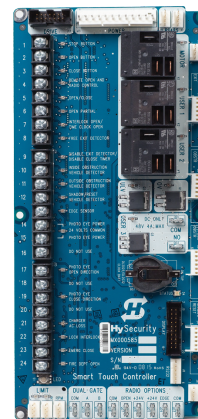

- Free Exit
- Inside Loop
- Outside Loop
- Center Loop

Hy-5B Vehicle Detectors (up to 4) plug into sockets



Correction, High Security

Custom Applications

Correctional Facilities Model

SlideDriver Correctional offers three high security lock options and a heavier, 10-gauge steel cover for added protection. HySecurity Correctional Facility gate operators come standard with all software needed to interface with common options and interlocks used at correctional facilities, such as gate position outputs, interlock capacity for sally ports or sequenced gates, and multiple relays for an external solenoid lock or other customizable options.

- **Highest security.** Heavier, 10-gauge cover with a high security lock for added protection. Easy to program for sally port, external lock mechanisms, and gate position indicator. Available with an optional internal deadbolt gate lock.
- **Three lock options.** Deadbolt, padlock and T-lock
- **Easy to integrate.** Shipped ready to interface with common options and interlock capability for sally ports and an interface relay to control an external solenoid lock.



Applicable Models:

SlideDriver 30F-C, 30F-C UPS, 30F-CM, 40-C, 40-CM, 40-C UPS, 50VF2/3-C, 50VF2/3-CM, 80-C, 80-C UPS, 200-C, 200-C UPS

Solenoid lock is not available with UPS models

Choose your lock:

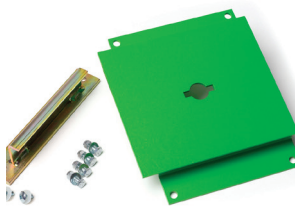

Deadbolt Prep:

Plate is designed to accommodate a 1010 deadbolt lock

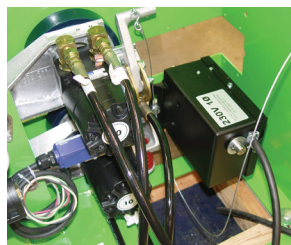

Internal Solenoid Lock:

Deadbolt lock employs a 3/4 inch (19mm) stainless-steel lock pin to lock the gate in the closed position

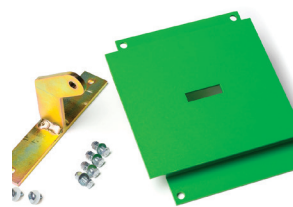

Padlock Prep:

Plate is designed to accommodate a standard padlock

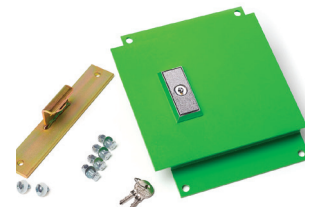

T-Lock:

Option includes the T-lock

Modular

SlideDriver Modular remotely locates all hydraulics and controls in a separate lockable enclosure for sites requiring unique mounting, highest security, blast mitigation or areas requiring noise reduction.

- **Highest security.** Threat of vandalism or unauthorized operator programming is greatly reduced with the Smart Touch Controller, electric motor assembly and pump rack remotely located in the HydraSupply. The only parts remaining in the operator are drive wheels, hydraulic motors and limit switches.
- **Blast mitigation.** In factories or other areas where gases or airborne particulate could pose an explosive danger, modular SlideDrivers remotely locate most electrical components, protecting against possible ignition of combustible materials.
- **Quiet.** Choose modular for noise-sensitive sites.



Remotely Located Enclosure

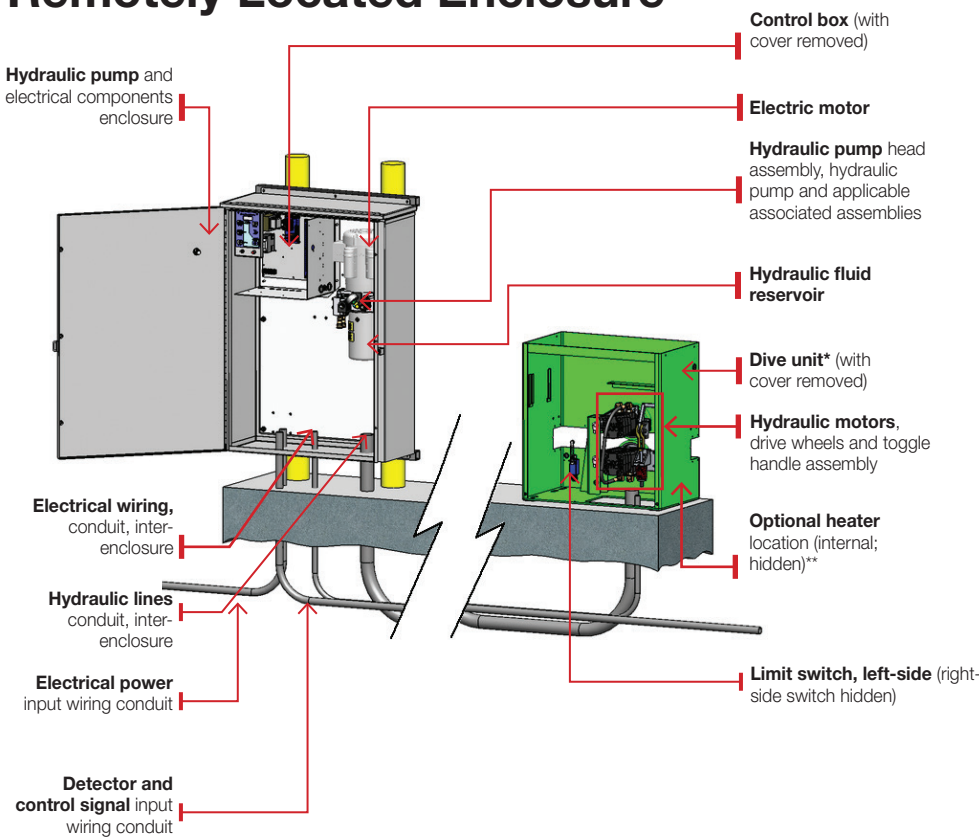

Applicable Models:

SlideDriver 15-M, 15-M UPS, 30F-M, 30F-CM, 30F-M UPS, 40-M, 40-CM, 40-M UPS, 50VF2/3-M, 50VF2/3-CM, 80-M, 80-M UPS

Remote Location:

The Pump/Electrical Enclosure (shown post-mounted) can be on either side of the Drive Unit. It can also be wall-mounted and/or located remote from the Drive Unit.

HydraSupply enclosure may be located up to 100 ft (30.5 m) from operator. For longer than 100 ft runs, or extremely cold climates, call Hysecurity for hose specifications.

* Drive unit with two hydraulic motors shown; drive unit with four hydraulic motors is similar.

** The optional heater requires a separate electrical conduit (not shown) between the control box and drive unit.

Premium industrial slide gate operator

Maximum security combined with extreme durability
Move up to 20,000 lb Gates

SlideDriver 80 and 200

- **Move large, heavy gates** up to 20,000 lb (9,072 kg)
- **SlideDriver models 80 and 200** utilize HySecurity's XtremeDrive™ system for maximum pull force
- **SlideDriver 200** operates with a double-wide, four wheel drive
- **Retain full functionality during an AC power outage** using HySecurity's advanced DC Power Supply with HyCharger DC™, a powerful 50A three stage charger, designed and built for continuous duty and long battery life.
- **Seamless synchronization** with all HySecurity operators for dual gate, sally port or sequenced gate integration



SlideDriver 200



SlideDriver 200 operates crash gate at power substation

XtremeDrive™ System

Another HySecurity Innovation

- **XtremeDrive System** comes standard with SlideDriver 80 and 200 and is optional with all models
- **Heavy gates operate more reliability** in severe weather including conditions where excessive ice, snow, blowing salt, sand and dust build up on the drive rail.
- **Provides maximum pull force** and traction for exceptionally hard to move gates.*
- **Cogged lower wheel** engages a matching cogged rack and increases traction the entire length of drive rail under the worst conditions.
- **Easy retrofit.** Replace smooth bottom wheel with XtremeDrive wheel, and add rack to existing drive rail. XtremeDrive wheel fits standard SlideDriver wheel mounts.

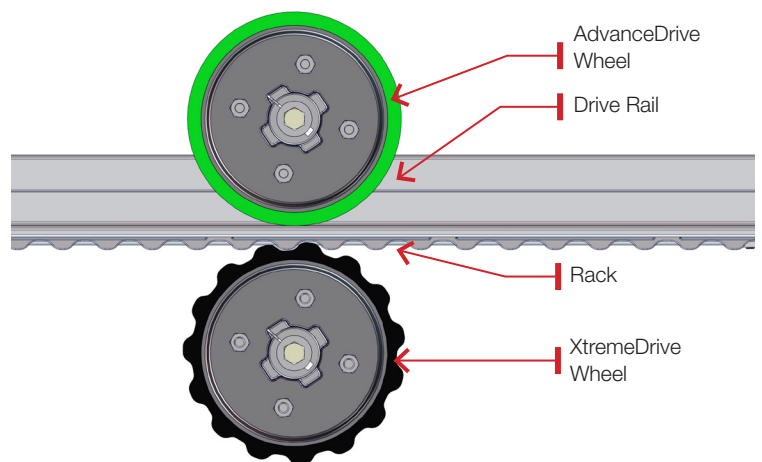

* HySecurity XtremeDrive System does not replace an improperly adjusted gate operator or a poorly maintained or installed gate. Ensure your operator and gate are installed and maintained according to the manufacturer's guidelines before retrofitting XtremeDrive. If you are retrofitting a SlideDriver with XtremeDrive you will have to raise the drive rail ¼" to ½".

Maintain security even after AC power loss

HySecurity UPS backup systems keep vehicle barriers and access control points alive and cycling after AC power loss.

DC Power Supply with HyCharger DC

A powerful 50A three stage charger, custom built for continuous duty and long battery life.

- Redundant charges increase security & reliability
- Burst of power when needed
- Smart charge system uses high efficiency switching technology that optimizes battery conditioning, storage capacity and battery life.
- Duty cycle: continuous
- Input power: 115*, 208/230 VAC; 50/60 Hz, single phase
- Minimum 2 hr recharge; 12 hrs for high cycle applications
- Wide temp rating: -40° a 70 °C (-40° a 158 °F)
- Climate controlled heating and cooling



SlideDriver 40 UPS at aviation facility



*115V DC Power Supply requires 30A branch circuit

AC Power Supply w/ HyInverter AC

Back up ALL HySecurity Variable Frequency (VF) operators including SlideDriver 50VF2/3.

- AC Power Supply field retrofits competitor 1 hp operators
- Install anywhere on branch circuit, from operator to protected facility
- Quick power transfer: ½ AC cycle
- Input power: 208/230VAC, 50/60Hz, single phase
- Minimum 6 hr recharge; 12 hrs for high cycle applications
- Wide temp rating: -40° to 50°C (-40° to 122°F). Heater and fan automatically adjust cabinet temperature for optimal battery life
- Programmable with Smart Touch Controller or SmartTouch 720/725



SlideDriver 50VF2/3 at Data Center



Accessories and System

Design Support



Base extension

Raise SlideDriver up 12 inches for additional conduit accessibility and operator flexibility.

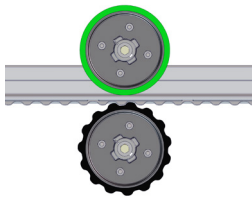

XtremeDrive™ System

Handle exceptionally difficult to move, large or heavy gates with the XtremeDrive rack and drive wheel system.



Hy5B™ Detector

Trouble-free configuration allows extensive system diagnostics and recording of all loop fault conditions.



Heater Kit

Maintain the reliability of the SlideDriver even in icy and snowy conditions with a heater kit.

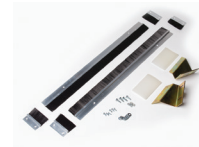

Snow brush and scraper kit

Reduce snow and ice buildup. Allow the wheels to make direct contact with the drive rail to reduce slippage.



Internal solenoid kit

As a standard specification on correctional sites, the internal solenoid lock provides the additional security that these sites demand.



Fire Release

Fire and emergency access lock box provides fast gate entry in case of emergency.



Photo Eye Kits

When safety is a priority, photo eyes are the solution. Detect pedestrians or cars before they become entrapped.



Radio Receivers & Transmitters

Remotely operate your gate.



ASO Edge Sensors

Wraparound square, round or channel mount with 10k ohm resistor.



Hy8Relay™

Add 8 user relays to your HySecurity operator. Integrated with Smart Touch controller using S.T.A.R.T.



Amber Strobe Beacon, 24VDC

Add 360 degrees of visible warning during gate operation.



Push Button Station, 2 or 3 Button

Manually control gate operator through control station from a distance by pushing a button.



Clock Timer

Seven day, 24 hour timer.

SlideDriver™ Gate System

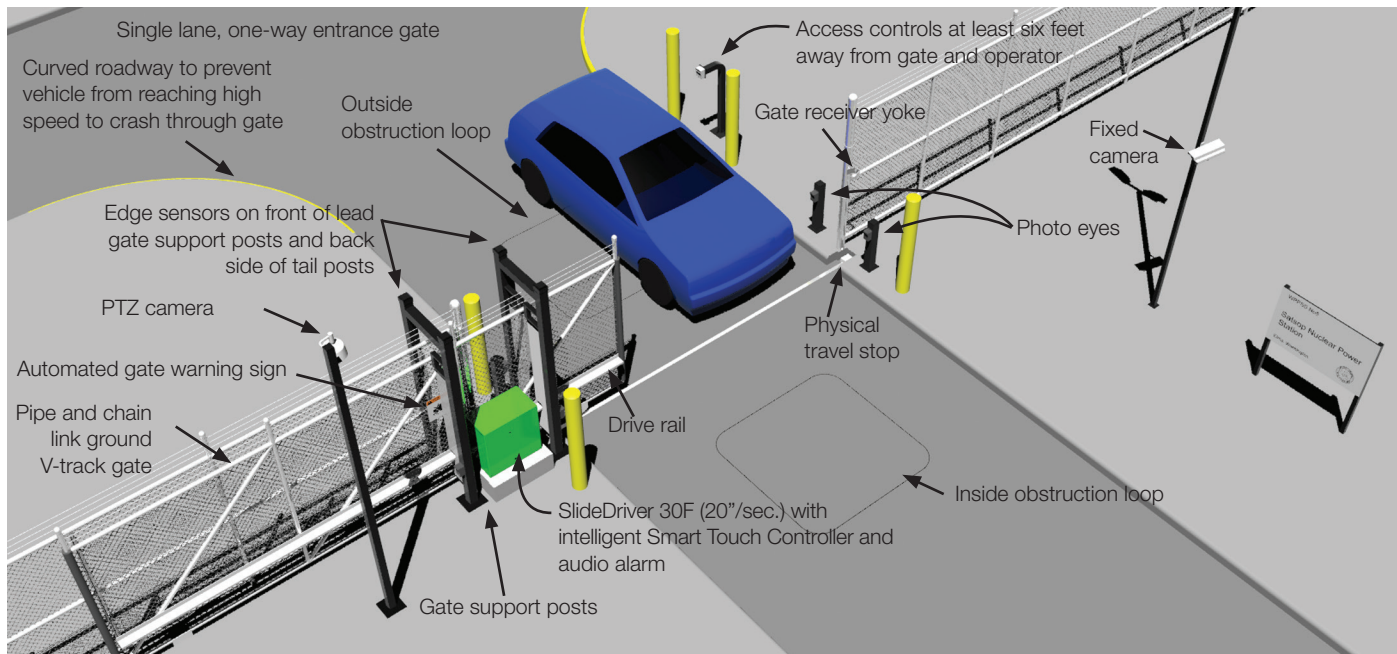

SlideDriver gate system with required and optional accessories.

We help hundreds of specifiers successfully design highly complex automated gate systems

Our highly experienced specification professionals save you time by helping you identify what components your project needs, then recommending latest technology and best solutions for you and your client. As Certified Automatic Gate System Designers, their years of hard won experience and knowledge will guide you through industry safety standards to help ensure your project's compliance. Their total immersion in this dynamic and growing industry safeguards your project's design and execution success.

Call for System Design Support 1-800-321-9947



SlideDriver UPS



Petrochemical



Corrections



Tank Farm



Data Center



Transit



Airport



a Nice company

support.hysecurity.com

Nice/HySecurity is an industry leader of automated gate and perimeter security solutions.

The HySecurity brand provides high-quality, ultra-reliable industrial gate operators and crash-rated, Hostile Vehicle Mitigation (HVM) vehicle barriers designed to secure and protect critical infrastructure and facilities worldwide.



Niceforyou.com

©2023 Nice North America LLC. All rights reserved.

HySecurity is a registered trademark of Nice North America LLC.

All trademarks, logos and brand names are the property of their respective owners.

9481816401 Rev-B 09/2023 D0795