

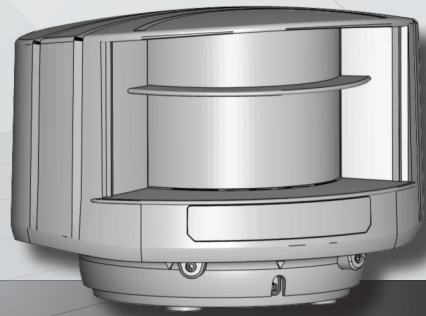

EN



LZR[®]-H100

LASER SCANNER FOR BARRIERS & GATES
with max. detection range of 32' × 32'

User's Guide



Visit website for
available languages of
this document.



READ BEFORE BEGINNING INSTALLATION/PROGRAMMING/SET-UP

SAFETY

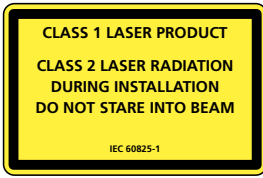

The device emits invisible (IR) and visible laser radiation.

IR laser: wavelength 905nm; output power 0.10mW
(Class 1 according to IEC 60825-1)

Visible laser: wavelength 635nm; output power 0.95mW
(Class 2 according to IEC 60825-1)

The visible laser beams are inactive during normal operation.
The installer can activate the visible lasers if needed.

Do not stare into visible laser beams.



CAUTION!

Use of controls, adjustments, or performance of procedures other than those specified herein may result in hazardous radiation exposure.

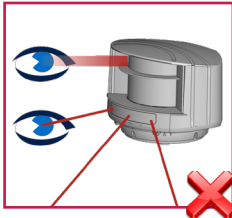

Do not look into the laser emitter or the visible red laser beams.

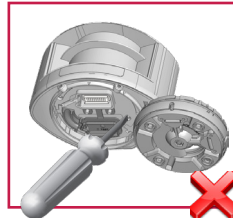

The warranty is void if unauthorized repairs are made or attempted by unauthorized personnel.



Only trained and qualified personnel are recommended to install and set up the sensor.

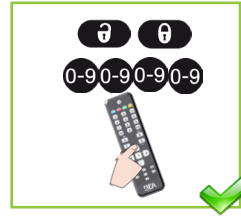

After installation, enter an access code by remote control.

This sensor is designed to be used as a movement and presence sensor to control the opening and the closing process of a gate or a barrier. The installer of the system is responsible for installing the sensor and the system in compliance with applicable national and international standards on safety. The manufacturer of the sensor cannot be held responsible for incorrect installations or inappropriate adjustments of the sensor.

This device is not intended for use in with any automatically activated doors. US Pat. No. 7,084,388, which is not owned by BEA, covers automatic doors comprising, among other things, a scanning detector. The LZR-H100 is not sold with consent, implied or otherwise, for use with automatically activated doors, as set forth in the aforementioned patent.

INSTALLATION AND MAINTENANCE



Avoid extreme vibrations.

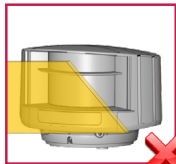

Do not cover the laser windows.

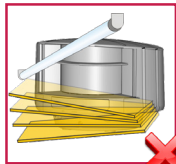

Avoid moving objects and light sources in front of the laser window.



Avoid the presence of smoke and fog in the detection field.



Avoid condensation on the laser windows.

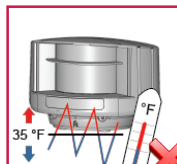

Avoid exposure to sudden and extreme temperature changes.

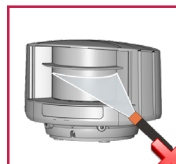

Avoid direct exposure to high pressure cleaning.



Do not use aggressive products to clean the laser windows.



Clean the laser window with compressed air. If needed, wipe only with a soft, clean and damp microfibre cloth.

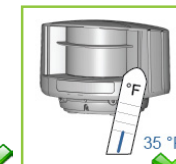

Keep the sensor permanently powered in environments where the temperature can drop below 35 °F.

READ BEFORE BEGINNING INSTALLATION/PROGRAMMING/SET-UP

DESCRIPTION

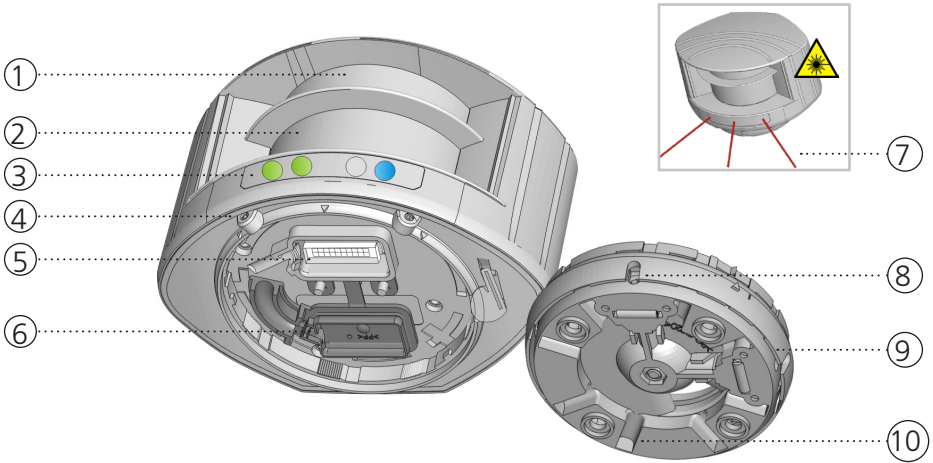

- | | |
|---------------------------------|--|
| 1. laser window – emission | 6. protection cover |
| 2. laser window – reception | 7. visible laser beams (3) |
| 3. LED signals (4) | 8. notches for tilt angle adjustment (2) |
| 4. screws for position lock (2) | 9. adjustable bracket |
| 5. connector | 10. cable conduits (4) |

LED SIGNAL

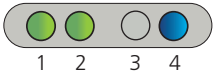

1. Detection LED: R1 – opening field
2. Detection LED: R2 – safety field
3. Error LED
4. Power LED

- LED flashes quickly
- LED flashes
- LED flashes slowly
- LED is off

- DETECTION LEDs**
- detection (red)
 - no detection (green)

- ERROR LED**
- error (orange)
 - no error (off)

- POWER LED**
- power (blue)
 - no power (on)

All 4 LEDs can be switched off and on again by remote control. This can be useful in cases where the sensor should not draw any attention.

SYMBOLS

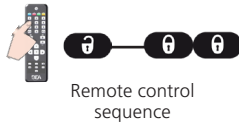

READ BEFORE BEGINNING INSTALLATION/PROGRAMMING/SET-UP

HOW TO USE THE REMOTE CONTROL



After unlocking, the red LED flashes and the sensor can be adjusted by remote control.



If the red LED flashes quickly after unlocking, you need to enter an access code from 1 to 4 digits.



To end an adjustment session, always lock the sensor.

ADJUSTING ONE OR MORE PARAMETERS



CHECKING A VALUE

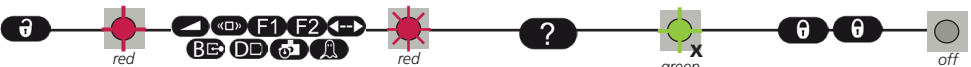

4
 1
 2 = field width: 4.2 m

3 = field width is defined by Learn

X = NUMBER OF FLASHES = VALUE OF THE PARAMETER

RESTORING TO FACTORY VALUES

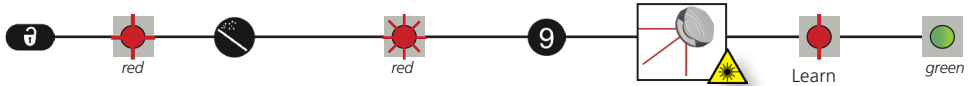

SAVING AN ACCESS CODE

The access code is recommended for sensors installed close to each other.



DELETING AN ACCESS CODE

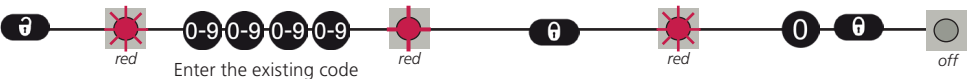

Enter the existing code



30 minutes after last use, the sensor locks access to the remote control session. To regain access, cycle the power. The remote control session will then be accessible for another 30 minutes.



BASIC SETUP FEATURES

It is important to understand the basic setup features before installing the sensor.

VISIBLE RED LASER BEAMS

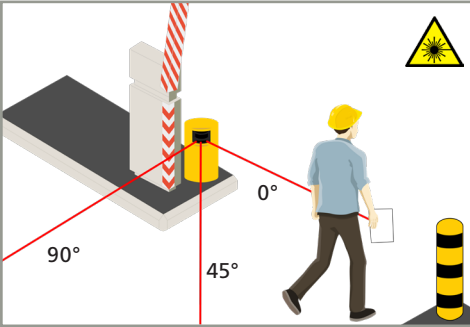

The sensor and detection field position are very important for the safe operation of the barrier.

In order to position the sensor correctly, use the 3 visible red laser beams.



The visible laser beams are also used to determine the location of the reference of the sensor.

REFERENCE

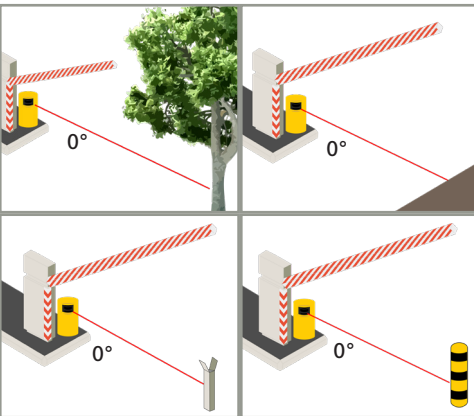

The sensor must learn a reference when the safety field is the only protection against contact between the vehicle and the boom.

The reference can be adjusted on any type of object already present on site (wall, tree, barrier boom support) or on a post.

Always make sure the object on which the reference is adjusted:

- is positioned in the continuity of the 0° laser beam
- is positioned min. at the end of the barrier or farther away than the end of the barrier
- has a surface of at least 6 inches
- is firmly fixed to floor and not subject to vibrations

Always ensure that the maximum distance for the reference teach-in is 9.9 m. Any farther away from this will result in an unsuccessful teach-in.



FOR BEST RESULTS:

- use the reflective sticker
- place the sticker horizontally on a cylindrical surface of the structure (as shown)
- center the laser's red spot on the reflector

Use reflective sticker (supplied) when the distance between sensor and reference is higher than 16.5 feet.

SAFETY FIELD

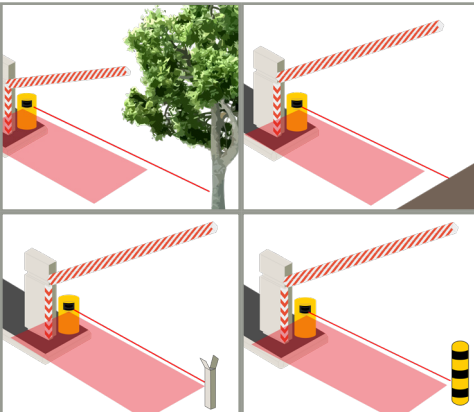

If the safety field is the only protection against contact with the barrier, the safety field of the sensor must be situated directly below the barrier.

This is only possible when the sensor is positioned correctly and the reference has been learned.

If the reference is situated at the end of the barrier, the detection field width is the same as the reference distance.

If the reference is farther away, adjust the detection field width to the width of the barrier.

In order to maximize safety for mixed traffic (vehicles and trucks), an additional vertical detection zone is recommended (LZR-130).

APPLICATION REQUIREMENTS

These requirements ensure optimal safety of the barrier in order to protect against contact with the barrier.

DOUBLE ACCESS LANE

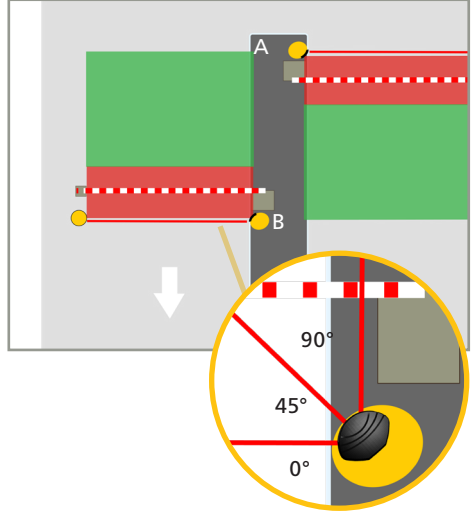
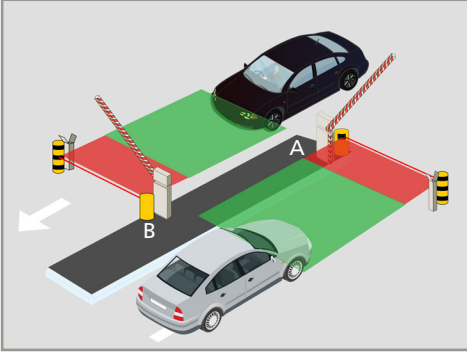

- 2 LZR-H100
- 2 references, 1 for each sensor

SINGLE ACCESS LANE

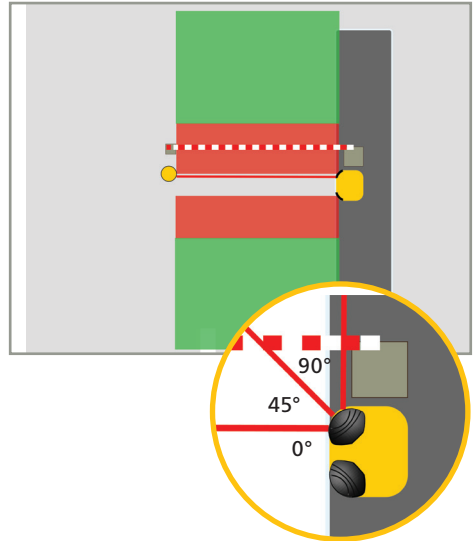
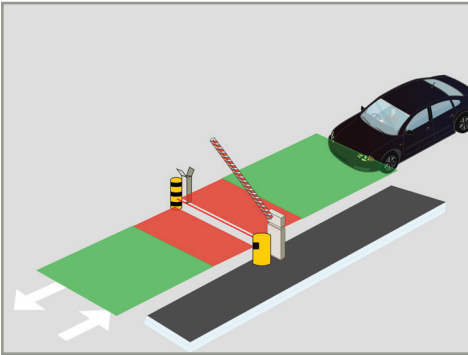

- 2 LZR-H100
- 1 reference

 SAFETY FIELD

 OPENING FIELD

RECOMMENDED MOUNTING

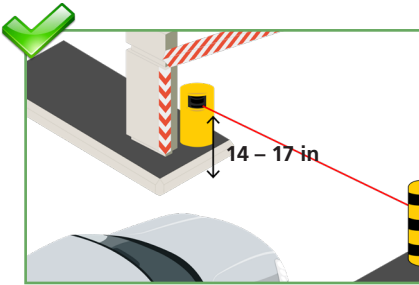

Install the sensor at a mounting height between 14 – 17 inches. If the barrier is only used by trucks, the mounting height may be increased.

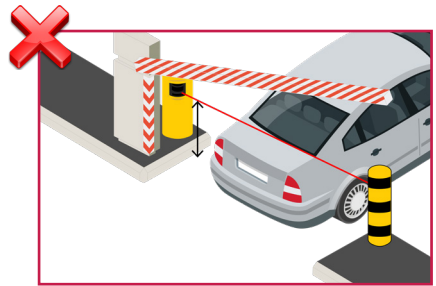

If the 0° reference beam is too low or too high, vehicle contact with the barrier may occur.

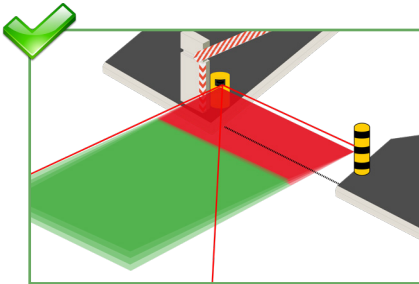

Ensure that the detection field is parallel to the barrier.

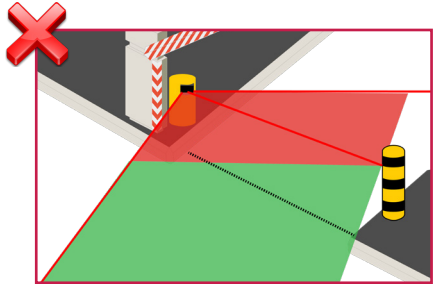

Do not position the detection field as shown.

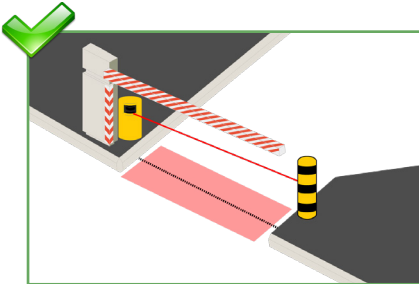

When using the safety field, place the sensor just behind the barrier to ensure that the safety field protects the area around the barrier.

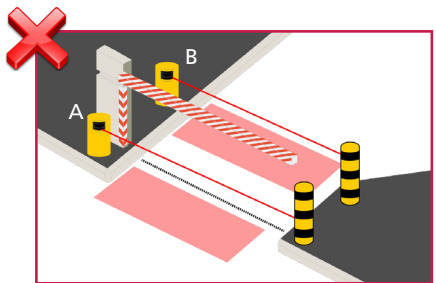

When using the safety, do not place the sensor before the barrier (A) or more than 15 inches after the barrier (B). The area around the barrier is not safe.

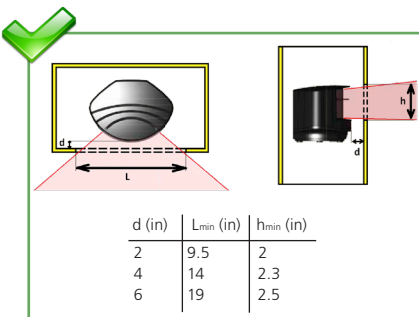

Ensure there are no obstructions in front of the sensor!



Do not cover the front face of the sensor with glass or plastic.

1 MOUNTING



Carefully read the application requirements and tips before mounting the sensor.
Mounting position of the sensor is crucial for safe operation of the barrier.

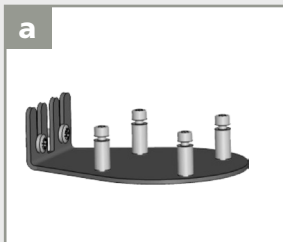

Use a mounting post or a mounting accessory (e.g. LBA accessory) to secure the sensor to the pole.

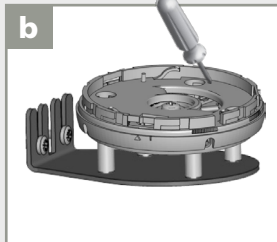

Position the bracket and secure using the 4 screws to avoid vibrations.



Open the protection cover, plug the connector and position the cable in the raceway.

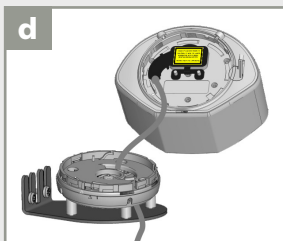

Firmly close the protection cover. Do not pinch the cable.

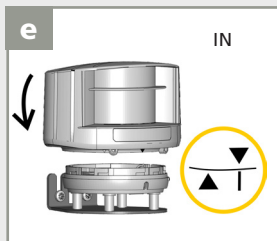

Position the housing on the bracket.

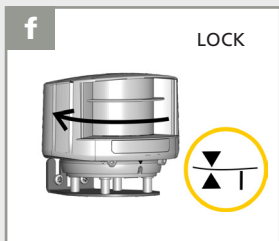

Turn the sensor until the two triangles are aligned.

2 WIRING

Use the visual aid below to ensure correct wiring to the door control.

WIRE COLORS	FUNCTION
Red (+) Black (-)	Power supply (10 – 35 VDC)
White Green	Relay 1: Opening Field
White/Black Green/White	Relay 2: Safety Field
Blue (+) Blue/White (-)	Test
Orange Orange/Black	Learn

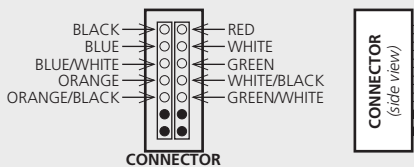

No test function:
Connect BLUE (DC+) and BLUE/WHITE (DC-) to power supply. (no polarity)

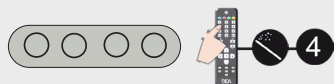
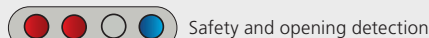
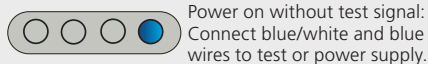
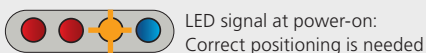

3 FIELD POSITIONING

 The detection field and reference position are very important for safe operation of the barrier.

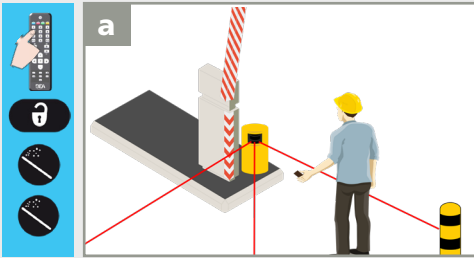

Activate the visible laser beams by remote control to position the sensor fields correctly.

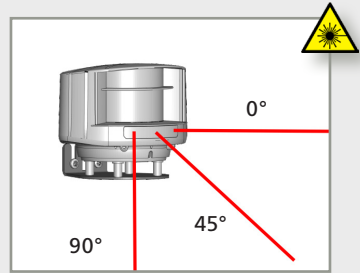

To turn off the beams, use the same sequence. After 15 minutes, the beams turn off automatically.

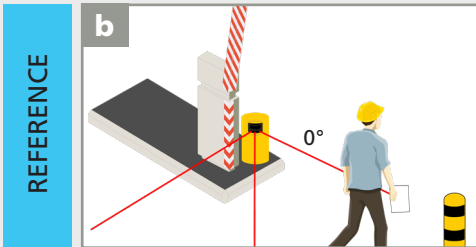

Use a sheet of white paper to verify that the laser beam is positioned at 0°. The reference point can be adjusted on any object at the end of the barrier or farther away. Its surface should be at least 6 inches wide and it must be secured. Use the reflective sticker when the distance between sensor and reference is more than 16 feet (see page 5).

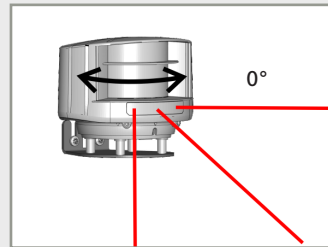

Turn the sensor slightly on its axis to adjust the lateral angle of the sensor to place the 0° laser spot on the reference.

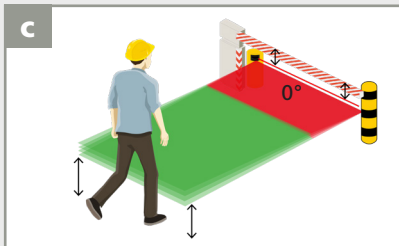

- The reference must be parallel to the barrier.
- The beginning of the opening field should be approximately 15 inches above the ground.

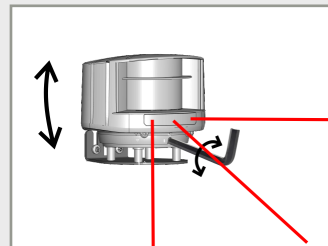

Adjust the tilt angle of the detection field with the hex key if necessary.

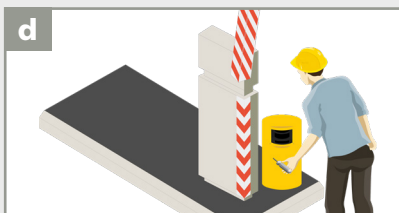

To finish, lock the sensor position using a screwdriver.

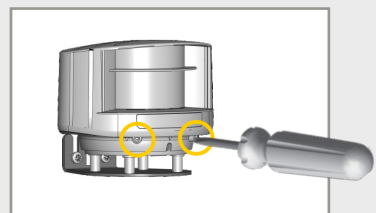

4 MOUNTING SIDE & REFERENCE

Select the correct mounting side with or without reference.



For best detection performance, use the sensor with the reference point.

WITH REFERENCE

(RECOMMENDED)

WITHOUT REFERENCE

LEFT

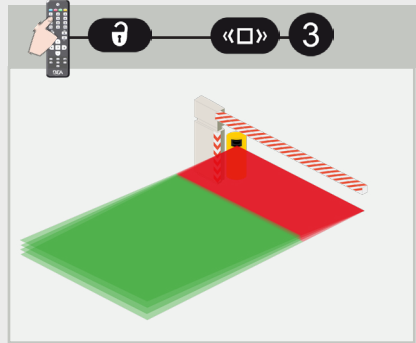
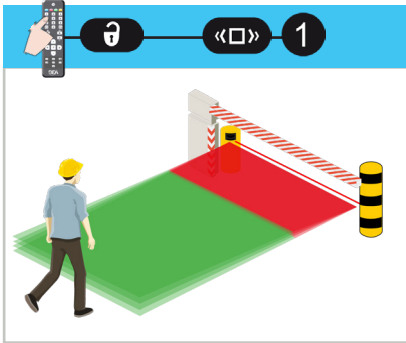

RIGHT

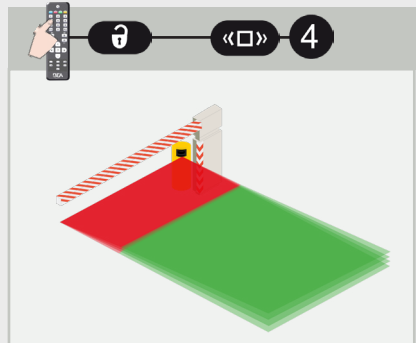
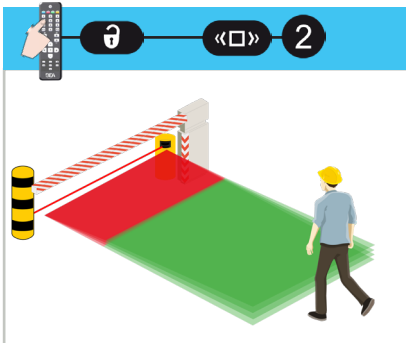

By default, the sensor automatically adjusts the width of the safety field based on the reference.

NOTE: Once determined, the reference point should not be altered. Any change to the reference point will cause the sensor's reference to go into detection.

5 SAFETY FIELD

FIELD DIMENSIONS

Before launching a learn, the field dimensions can be adjusted by remote control.

Dimensions must be entered using the metric system - convert if necessary.

Value C must be adapted to the width of the barrier:

- when the reference point is farther away than the desired detection field width
- when a mounting side **without reference** has been selected

WIDTH

C ↔ **00** (auto-set to reference*) MIN **05** - MAX **96**

0.5 m 9.6 m

* without reference, the width will be automatically set to 9.9 m

DEPTH

D ↑↓ **05** - **96**

0.5 m 9.6 m **2.0 m**

EX:  **C** **D** **15** for a field depth of 1.5 m

You can also increase or decrease the field in increments of 10 cm: **C** **+/-** **D** **+/-**

LEARN

Launch a learn by remote control. You have 3 seconds to step out of the detection field. Then wait for the sensor to learn its environment (30 seconds).

During the learn, the detection field must be free of snow buildups, heavy rain, snowfall, fog or other moving objects.

If you walk along the detection area while the learn function is active, the sensor memorizes the outline of the walk path and stores this as a new detection field. The shortest distance measured by each laser beam is stored by the sensor and determines the field limit.

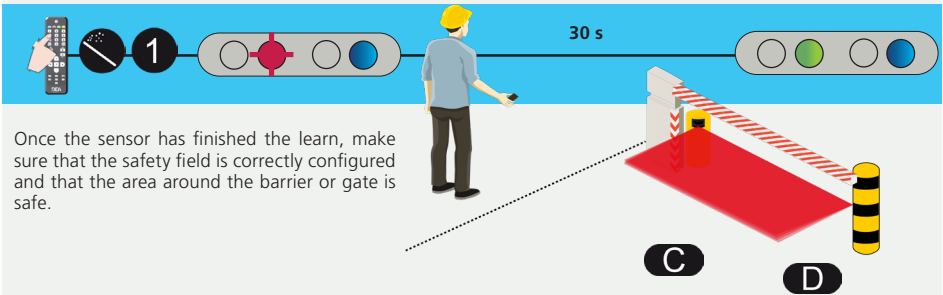

30 s

C **D**

Once the sensor has finished the learn, make sure that the safety field is correctly configured and that the area around the barrier or gate is safe.



Always launch a new learn after adjusting the field dimensions.

If the safety field is the only protection against contact with the boom, the safety field of the sensor must be situated right under the barrier. This is only possible when the sensor is positioned correctly and the reference has been learned.

The safety field is necessary for the correct functioning of the installation. If the safety field is badly adjusted, the manufacturer of the sensor cannot be held responsible for inappropriate functioning of the installation. Always verify the correct functioning of the safety field before leaving the premises.

6 OPENING FIELD

FIELD DIMENSIONS

Before launching a learn, the field dimensions can be adjusted by remote control.

Dimensions must be entered using the metric system - convert if necessary.

WIDTH

A



00

same width as
safety field

MIN

05

0.5 m

MAX

96

9.6 m

DEPTH

B



00

if no opening
field is
needed*

05

0.5 m

96

9.6 m

* Setting the Opening Field to 00 will eliminate its output and LED function.

EX:



B

5

0

for a field depth of 5 m

You can also increase or decrease the field in increments of 10 cm:



LEARN

Launch a learn by remote control. You have 3 seconds to step out of the detection field.

Then wait for the sensor to learn its environment (45 seconds).

During the learn, the detection field must be free of snow buildups, heavy rain, snowfall, fog or other moving objects.

If you walk along the detection area while the learn function is active, the sensor memorizes the outline of the walk path and stores this as a new detection field. The shortest distance measured by each laser beam is stored by the sensor and determines the field limit.

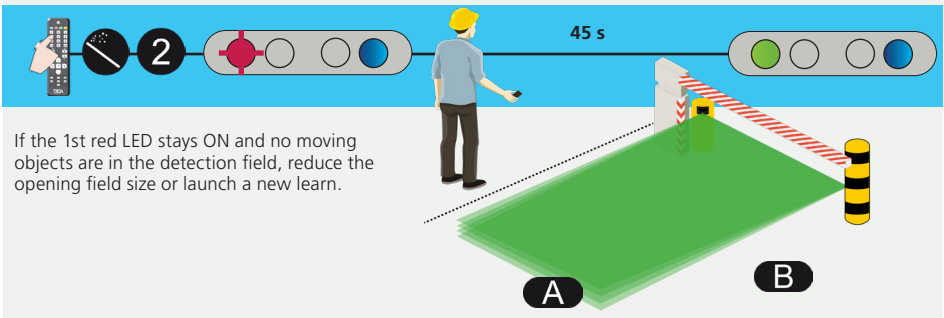

If the 1st red LED stays ON and no moving objects are in the detection field, reduce the opening field size or launch a new learn.



Always launch a new learn after adjusting the field dimensions.

REMOTE CONTROL ADJUSTMENTS (OPTIONAL)

PEDESTRIAN FILTER

opening field

Select value 3 or higher to reject pedestrians. All objects wider than the selected size will be detected.

	1	2	3	4	5	6	
	off	50	65	72	100	120	cm

approximate values

MAX. PRESENCE TIME

opening field

STANDSTILL IN OPENING FIELD:

Select the amount of time R1 should stay active after an object becomes still in the opening field.

	0	1	2	3	4	5	6	7	8	9
	off	5 sec	10 sec	30 sec	1 min	2 min	5 min	10 min	2 hour	∞

DETECTION DELAY

opening field

ENVIRONMENT FILTER:

Increase value in case of heavy rain, snow, or moving objects in the environment.

	0	1	2	3	4	5	6	7	8	9
	off	100	200	300	400	500	600	700	800	900 ms

approximate values

OUTPUT FUNCTION

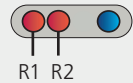

F1	0	1	2
RELAY 1	motion	motion or presence	motion + presence
RELAY 2	presence	presence	presence

OUTPUT CONFIGURATION

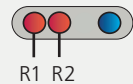





	1	2	3	4
RELAY 1	A – NO	P – NC	P – NC	A – NO
RELAY 2	P – NC	A – NO	P – NC	A – NO

FACTORY VALUE

REMOTE CONTROL ADJUSTMENTS (OPTIONAL)

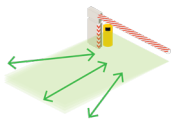
DETECTION TRAJECTORY

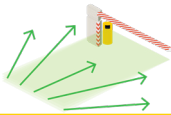
opening field

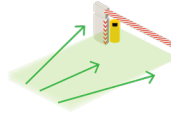
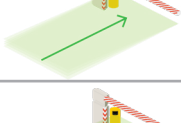
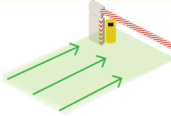
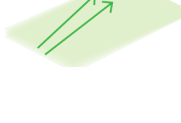
			
BIDIRECTIONAL	bidirectional detection approaching + departing		1
UNI 400%	unidirectional detection only approaching in any direction		2
UNI 200%	unidirectional detection only approaching towards the barrier/gate		3
UNI 100%	unidirectional detection only approaching within width of barrier/gate		4
UNI 50%	unidirectional detection only approaching towards central zone of barrier/gate		5
UNI CENTER	unidirectional detection only approaching towards center of barrier/gate		6
UNI RIGHT	unidirectional detection only approaching towards right side of barrier/gate		7
UNI LEFT	unidirectional detection only approaching towards left side of barrier/gate		8

IMMUNITY



1

2

standard

high

NOTE: Select "high" if fog is causing unwanted detections.

MAGIC WAND



1

2

9











learn
safety field

learn
opening field

factory
values

visible
laser beams

TROUBLESHOOTING

 No blue LED	No power Polarity of power supply is inverted All LEDs have been deactivated by remote control	Check cable and connection. Check the polarity of the power supply. Activate LEDs using remote control.
 Only blue LED is on	Test input is not connected	Check wiring. The blue and blue/white cable must be connected to the test input or the power supply.
 Detection LED remains green	Detection field too small or deactivated Object size is too small	Check size of fields. Launch a Learn. Decrease minimum object size.
 Detection LED remains red	Someone/Something is in the detection field Field is touching floor/wall/door – this leads to detection	Step out of the field and/or remove the any object(s) from the field. Activate the 3 red beams and check if the position of the sensor is correct. If not, adjust the hex screws. Verify the field size. Launch a Learn.
 Orange LED flashing and detection LEDs are red	No background (reference point) is found Sensor is masked	Check position of sensor. Check the mounting side setting. If no reference point is found, set the mounting side to value 3 to 5. Launch a new Learn. Verify and clean the front screens with a damp cloth.
 Orange LED is on Both detection LEDs are orange	Power supply voltage exceeds acceptable limits Sensor exceeds temperature limits Internal error	Check power supply voltage. Verify the temperature of the environment. Protect the sensor from sunlight using a cover, if necessary. Wait a few seconds. If the LED remains ON, reset the power supply. If the LED turns on again, replace the sensor.
 Sensor does not respond to the remote control	30 minutes after last use, sensor locks access to RC Remote control batteries not installed properly or are dead Remote control not pointed correctly Reflective object is close to the sensor	Cut and restore power supply. RC is accessible again for 30 minutes. Check battery orientation or replace the batteries. Point the remote control towards the sensor, but with a slight angle. The RC should not be pointed in a right angle in front of the sensor. Avoid highly reflective material in proximity to the sensor.
 Sensor does not unlock	Access code needs entered or an incorrect code was used	Cut and restore power supply. No code is required to unlock during the first minute after powering.



Can't find your answer?
 Visit www.beainc.com or scan QR code for Frequently Asked Questions!

TECHNICAL SPECIFICATIONS

Technology:	laser scanner, time-of-flight measurement (4 laser curtains)
Detection mode:	motion and presence
Max. detection field:	32' x 32' (9 ¾ m)
Min. detection field (safety):	1' 8" (½ m)
Remission factor:	> 2%
Angular resolution:	0.3516°
Emission characteristics	
IR laser:	wavelength 905 nm; output power 0.10mW (CLASS 1)
Red visible laser:	wavelength 635 nm; output power 0.95mW (CLASS 2)
Supply voltage:	10 – 35 VDC
Power consumption:	< 5 W
Peak current @ power-on:	1.8 A (max. 80 ms @ 35 V)
Cable length:	33'
Response time:	
motion detection:	typ. 200 ms (adjustable)
presence detection:	typ. 20 ms (max. 80 ms)
Output:	2 electronic relays (galvanic-isolated – polarity-free)
Max. switching voltage:	35 VDC / 24 VAC
Max. switching current:	80 mA (resistive)
Switching time:	t _{on} = 5 ms; t _{off} = 5 ms
Output resistance:	typ 30 Ω
Voltage drop on output:	< 0.7 V @ 20 mA
Leakage current:	< 10 µA
Test input:	2 optocouplers (galvanic-isolated – polarity-free)
Max. contact voltage:	30 VDC (over-voltage protected)
Voltage threshold:	Log. H: > 8 VDC Log. L: < 3 VDC
LED signal:	1 blue LED: power-on status 1 orange LED: error status 2 bi-colored LEDs: detection/output status (green = no detection, red = detection)
Dimensions:	3 ⅝" x 2 ¾" x 5" (W x H x D) mounting bracket: + ½"
Material:	PC/ASA
Color:	Black
Mounting angles on bracket:	-45°, 0°, 45°
Rotation angles on bracket:	-5 – 5° (lockable)
Tilt angles on bracket:	-3 – 3°
Protection degree:	NEMA 4 / IP65
Temperature range:	powered: -22 – 140 °F (-30 – 60 °C) unpowered: 14 – 140 °F (-10 – 60 °C)
Humidity:	0 – 95% non-condensing
Vibrations:	< 2G
Pollution on front screen:	max. 30%, homogenous
Norm conformity:	2006/95/EC: LVD 2004/108/EC: EMC IEC 60825-1:2007 IEC 61000-6-2:2005 2002/95/EC: RoHS IEC 60529:2001 IEC 60950-1:2005 IEC 61000-6-3:2006

EXPECTATIVAS DE CUMPLIMIENTO DE BEA, INC. CON RESPECTO AL SERVICIO Y LA INSTALACIÓN

BEA, Inc., el fabricante del sensor, no se responsabilizará por las instalaciones o los ajustes incorrectos del sensor o dispositivo. Por consiguiente, BEA, Inc. no garantiza ningún uso del sensor o dispositivo con fines distintos de los previstos.

BEA, Inc. recomienda firmemente que los técnicos de instalación y servicio cuenten con la certificación de la Asociación Estadounidense de Fabricantes de Puertas Automáticas (AAADM) para puertas peatonales, tengan la certificación de la Asociación Internacional de Puertas (IDA) para puertas o compuertas, y que, además, reciban la capacitación adecuada en fábrica para cada tipo de sistema de puerta o portones.

Los instaladores y el personal de servicio son responsables de llevar a cabo una evaluación de riesgo después de cada instalación o servicio, y de verificar que el rendimiento del sistema de sensores y dispositivos cumpla con las regulaciones, los códigos y las normas locales, nacionales e internacionales.

Una vez finalizado el trabajo de instalación o de servicio, se realizará una inspección de seguridad de la puerta o compuerta según las recomendaciones del fabricante y las pautas de la AAADM, el Instituto Nacional Estadounidense de Estándares (ANSI) o la Asociación de Fabricantes de Puertas y Sistemas de Acceso (DASMA) (cuando corresponda) con el fin de aplicar las mejores prácticas de la industria. Las inspecciones de seguridad se deben realizar durante cada visita de servicio. Se pueden encontrar ejemplos de estas inspecciones en una etiqueta de información de seguridad de la AAADM (p. ej.: ANSI/DASMA 102, ANSI/DASMA 107, UL294, UL325, y el Código Internacional de Seguridad). Verifique que todas las etiquetas de señalización y de advertencia, y los rótulos industriales se encuentren en su lugar.

Specifications are subject to change without prior notice. All values measured in specific conditions.



Tech Support & Customer Service: 1-800-523-2462

General Tech Questions: techservices-us@BEAsensors.com | Tech Docs: www.BEAsensors.com